

Chapter 32

Landing gear

TABLE OF CONTENTS

Chapter	Title	
32-10-00	LANDING GEAR	3
32-11-00	MAINTENANCE PRACTICES	5
32-11-01	Main Landing Gear	5
32-11-02	Top Half of the Mounting Clamp	5
32-11-03	Tail spring	6
32-11-04	Tail Wheel Fork Assembly	7
32-11-05	Tail Wheel	7
32-40-00	WHEELS AND BRAKES	9
32-40-01	General	9
32-45-00	MAINTENANCE PRACTICES	14
32-45-01	Master Cylinder	14

32-10-00

LANDING GEAR

The Extra 300 is designed as a conventional tail wheel airplane, with an unretractable landing gear.

The landing gear consists of a 2 wheel main landing gear and a tail wheel.

The main wheels are interconnected and attached to the fuselage by means of an U-shaped carrier. This carrier is of integral glasfibre design and incorporates wheel alignment, spring and dampening action. The attachment area to the fuselage is covered by a cuff of which the layer sequence is shown in Figure 1.

The tail wheel is self steering with full swivel capability.

The values for wheel rake and toe-in of the main landing gear are given in Figure 1A.

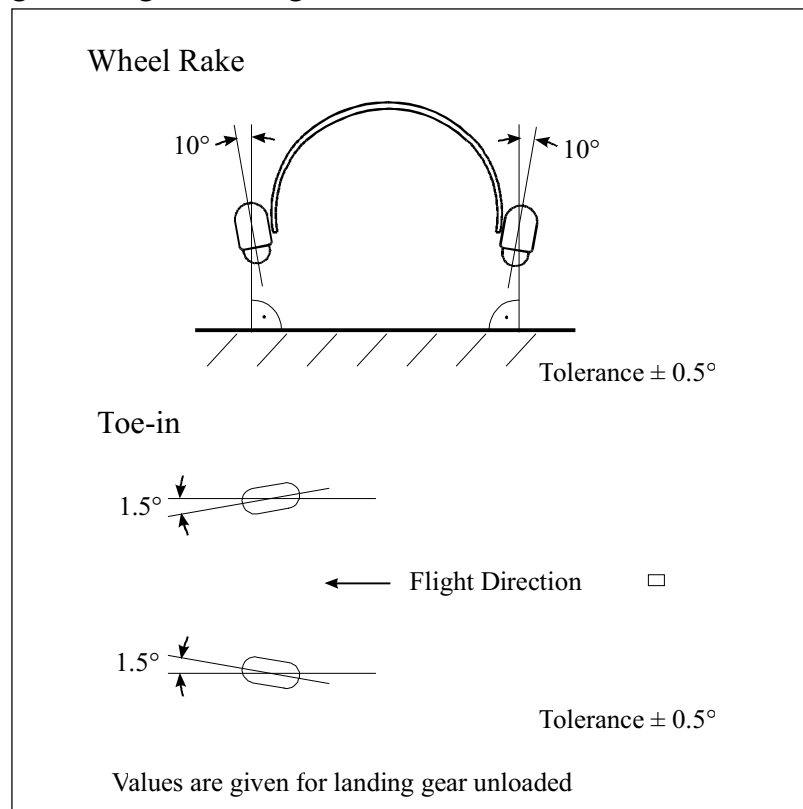

*Wheel Rake and Toe-in
Figure 1A*

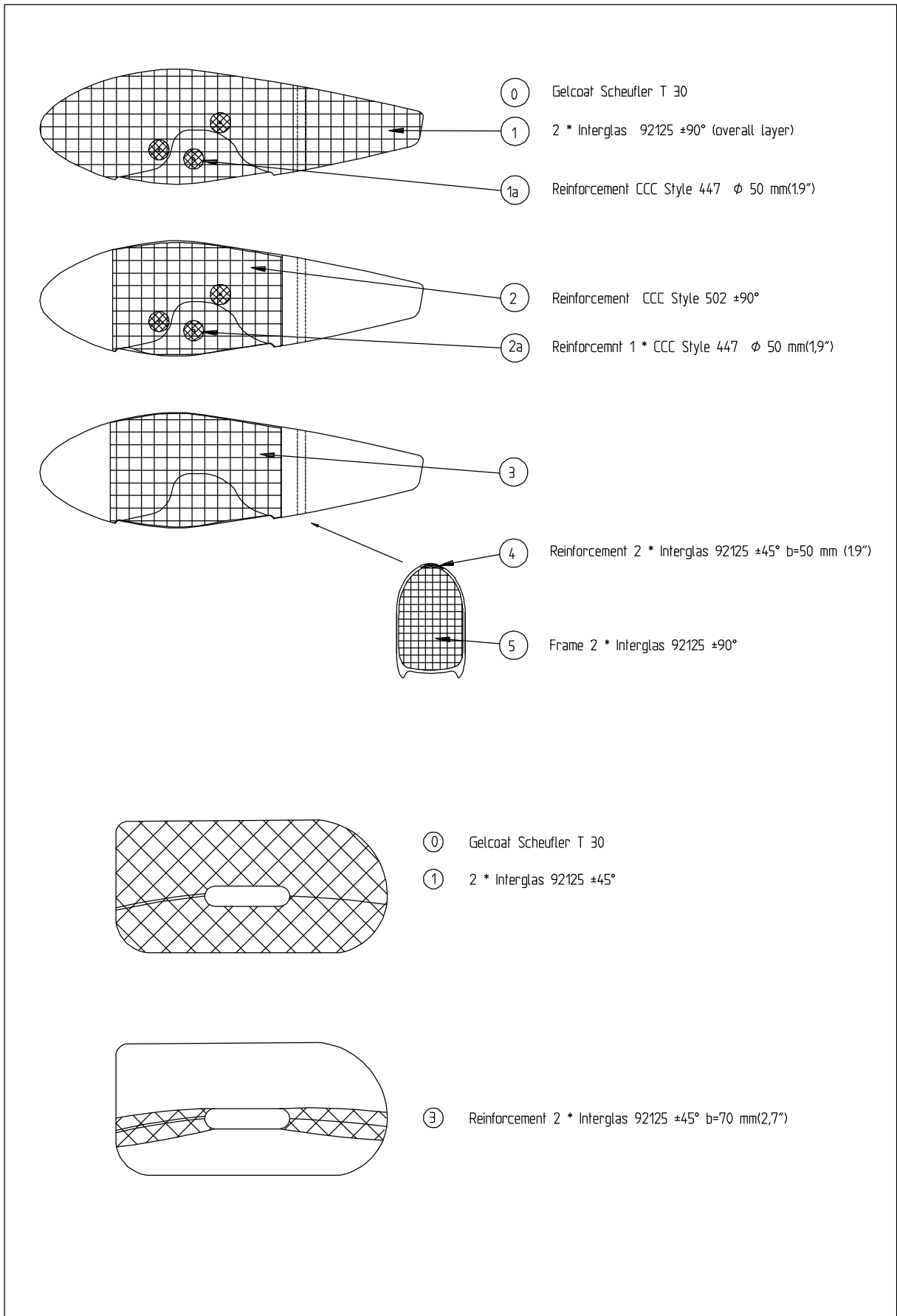

Layer Sequence Fairing and Cuff
Figure 1

32-11-00

MAINTENANCE PRACTICES

32-11-01

Main Landing Gear

Removal/Installation

Refer to Figure 2.

- 1 Remove the engine cowling, the landing gear cuffs and the 1. bottom covering sheet as per chapter 51-00-01.
- 2 Shore the aircraft as per Chapter 07-20-00
- 3 Drain brake system.
- 4 Unfasten the ventilation tubings and disconnect the brake lines from the brake assembly.
- 5 Remove the four landing gear attachment stop nuts (LN9348-10) (1) and the DIN 125 M10 washers.
- 6 Remove the bottom halves of the mounting clamps (2), the anti abrasion strips (3) and the landing gear (4).
- 7 Install in reverse sequence of removal using new stop nuts. For correct position of landing gear the mandrel, which is located at the bottom of the fuselage, is to put into the respective sleeve at the top of the landing gear spring. Replenish brake fluid per Chapter 12.

32-11-02

Top Half of the Mounting Clamp

Removal/Installation

Refer to Figure 2

- 1 Remove the main landing gear as per Chapter 32-11-01.
- 2 Remove the LN9348-10 stop nuts, the DIN125 M10 washers and the LN9037-10054 bolts (5).
- 3 Remove the top half of the mounting clamp (6).
- 4 Reverse procedure for installation.

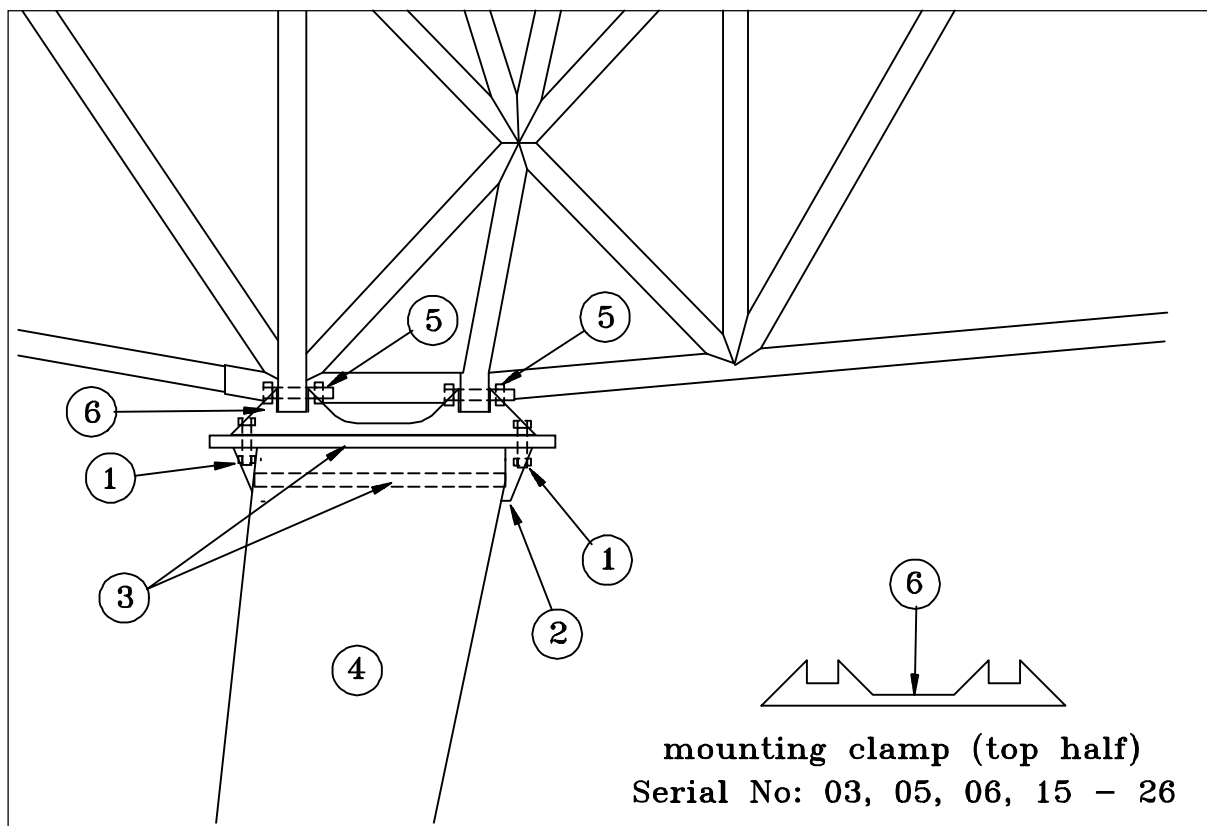

*Main Landing Gear Mounting
Figure 2*

32-11-03

Tail spring

Removal/Installation

Refer to Figure 3.

- 1 Shore the tail as per Chapter 07-20-02.
- 2 Remove the tail cone access panel as per Chapter 51-00-01.
- 3 Remove the tail spring attachment bolts (1-3).
- 4 Remove the tail spring (4).
- 5 Reverse procedure for installation; consider to fasten the breather line using the MS21919-DG12 clamp (5).

32-11-04

Tail Wheel Fork Assembly

Disassembly/Assembly

Refer to Figure 3.

- 1 Shore the tail as per Chapter 07-20-02.
- 2 Remove the attachment bolt, washers and stopnut (6).
- 3 Disassemble the special washers (7), bearings (8), and the tail wheel fork (9).
- 4 Reverse procedure for assembly.

32-11-05

Tail Wheel

Disassembly/Assembly

Refer to Figure 3.

- 1 Shore the tail as per Chapter 07-20-02.
 - 2 Remove the attachment bolt, washers, and stopnut (10).
 - 3 Remove the tailwheel.
 - 4 Disassemble the bearings (11), the wheel halves (12), the spacer sleeve (13), and the solid rubber tire (14).
 - 5 Reverse procedure for assembly.
- .

Note:

From Serial N° 64 the tail spring consist of a composite part and a steel shoe connected by two bolts.

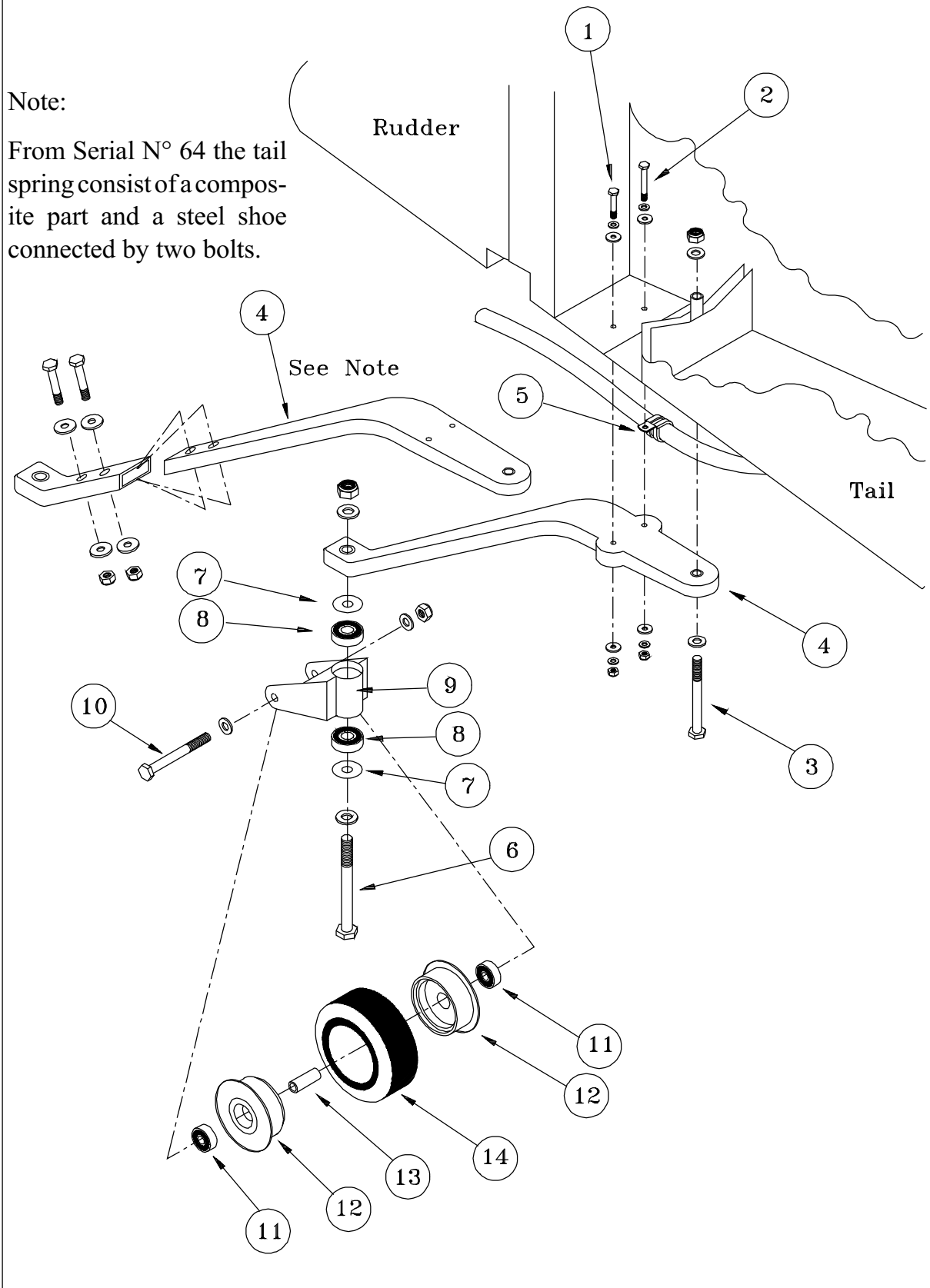

*Tail Wheel, Fork and Spring
Figure 3*

32-40-00

WHEELS AND BRAKES

32-40-01

General

This Chapter provides maintenance personnel with necessary procedures to accomplish both on-aircraft and off-aircraft maintenance of Cleveland design wheel and brake assemblies. Such maintenance shall include inspection, removal, servicing, refinishing, and installation of assemblies.

The main wheels have standard brand 500x5 rims, six-ply rated 5.00-5-tyres with tubes, according to FAA Standard TSO-C62. Up to Serial No. 54 Cleveland 40-78B type wheels with 30-9 type brake assemblies, and from Serial No. 55 Cleveland 40-151 type wheels with 30-164 type brake assemblies are used. The main wheels are covered with glas fibre designed fairings of which Figure 1 shows the layer sequence.

The tailwheel consists of a 5 inch tire and an aluminium rim.

The Cleveland design features an external brake in which the disc is external to the wheel with the brake caliper floating over the disc.

The brake system (refer to figure 4) consists of a brake assembly located at the inner side of the wheel, a master cylinder (1) at the front and rear rudder pedals each, and a brake fluid reservoir (2) mounted at the front master cylinder. From serial No. 23 a single brake fluid reservoir located at the cockpit side of the firewall is used. From Serial No. 57 the brake fluid reservoir is located at the engine side of the firewall. The Cleveland 10-20 master cylinders are mounted in line, so that the front cylinder loses his efficacy, when the rear cylinder has been actuated. The particular parts of the brake system are interconnected by brake lines consisting of aluminium tubes and flexible hoses (In Figure 4 details are only outlined, for accurate identification of parts refer to Figure 5. The capital letters in Figure 5 refer to the marks in Figure 4).

The tail wheel has no brake.

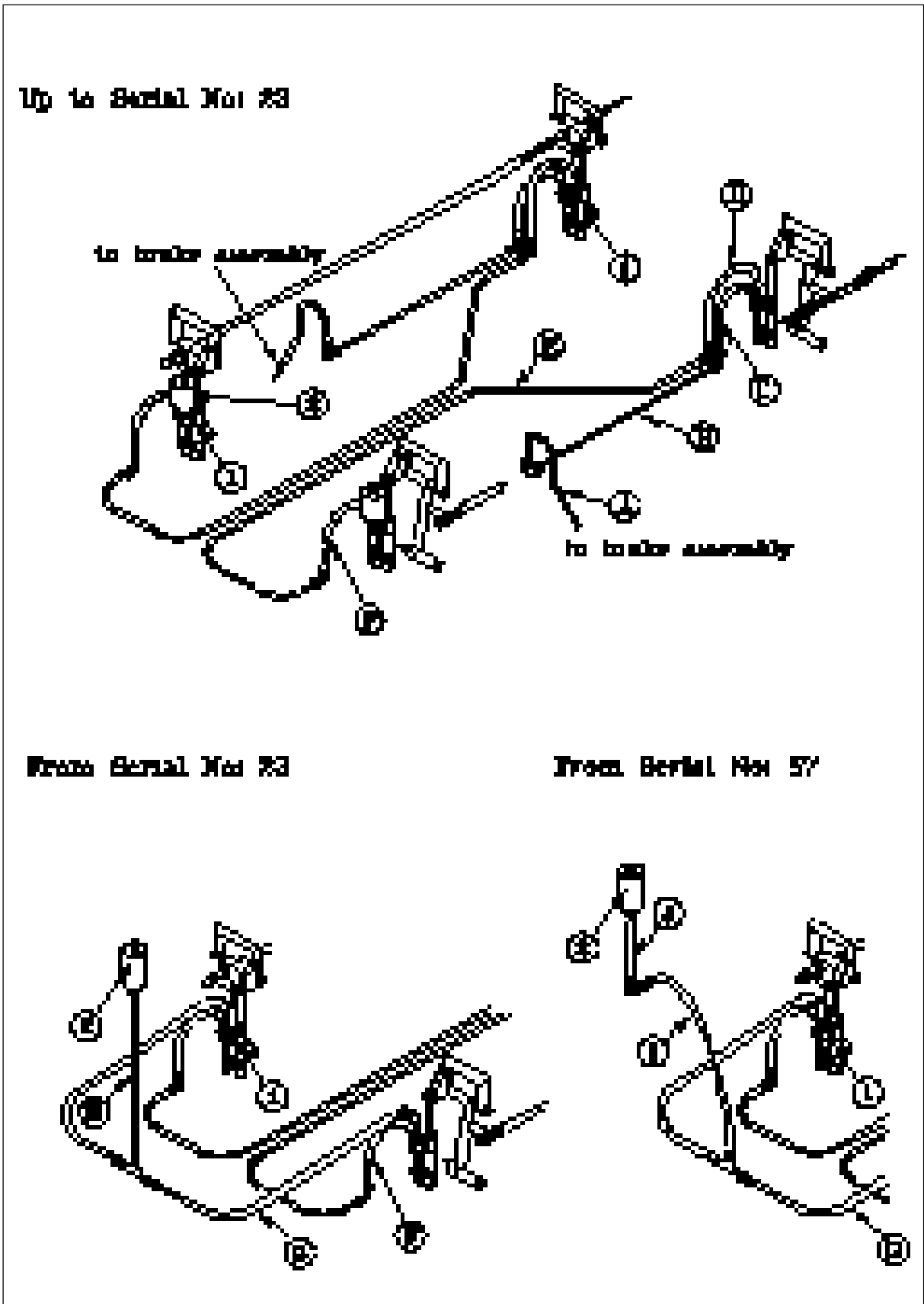

*Brake System (3 Versions)
Figure 4*

Brake assembly to outer fitting shackle connection (A)

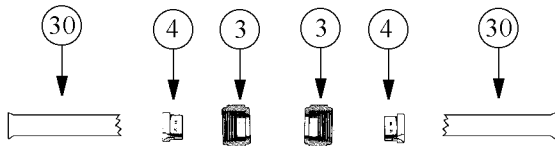

Outer fitting shackle to rear fitting shackle connection (B)

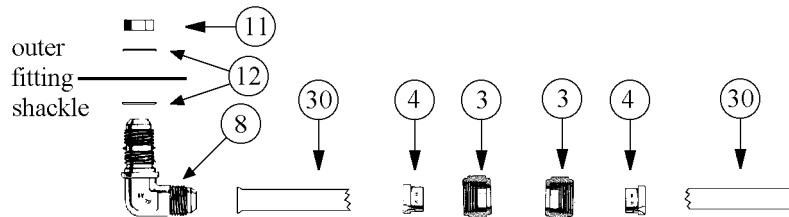

Rear fitting shackle to rear pedal bottom port connection (C)

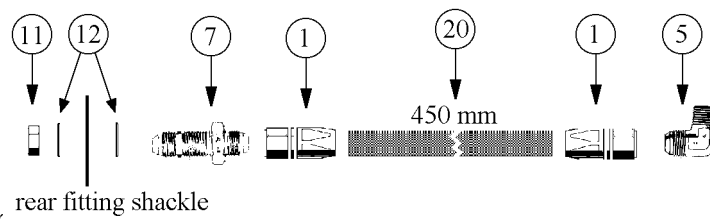

Rear pedal top port to rear fitting shackle connection (D)

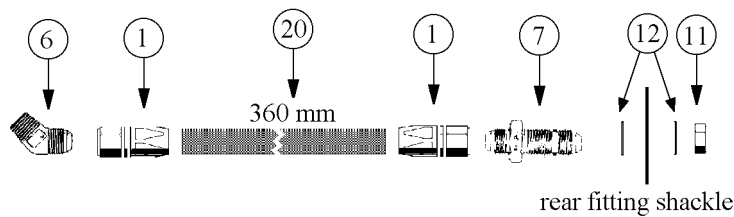

Rear fitting shackle to front fitting shackle connection (E)

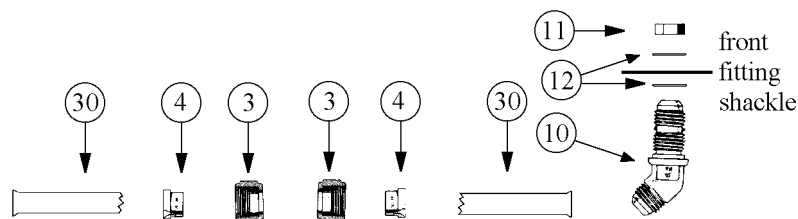

Fittings and washers

- 1 AEROQUIP 816-4D
PN: PC-00901
- 2 AN816-4D
PN: PC-00159
- 3 AN818-4D
PN: PC-00161
- 4 AN819-4D
PN: PC-00860
- 5 AN822-4D
PN: PC-00155
- 6 AN823-4D
PN: PC-00167
- 7 AN832-4D
PN: PC-00171
- 8 AN833-4D
PN: PC-00173
- 9 AN834-4D
PN: PC-01644
- 10 AN837-4D
PN: PC-00174
- 11 AN924-4D
PN: PC-00178
- 12 AN960-C716
PN: PC-00810

Hoses

- 20 AEROQUIP 701-4
PN: PC-00910

Tubes

- 30 alu tube 5052-0, Ø1/4 inch
PN: PC-00123

*Brake Lines
 Figure 5, Sheet 1*

Front fitting shackle to front pedal bottom port connection (F)

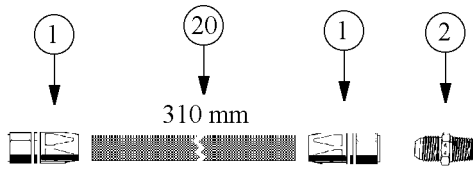

Front pedal top port to center fitting shackle connection (G)

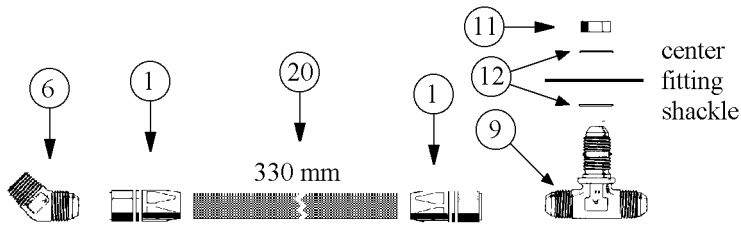

Center fitting shackle to single brake fluid reservoir connection (H) (Serial No. 23 - 56)

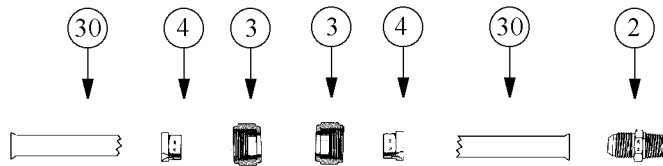

Center fitting shackle to firewall connection (I)
 (From Serial No: 57)

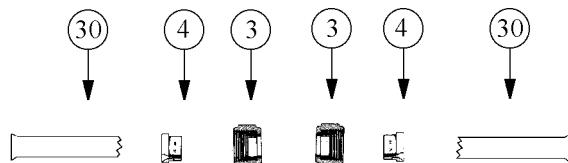

Firewall to single brake fluid reservoir connection (J)
 (From Serial No: 57)

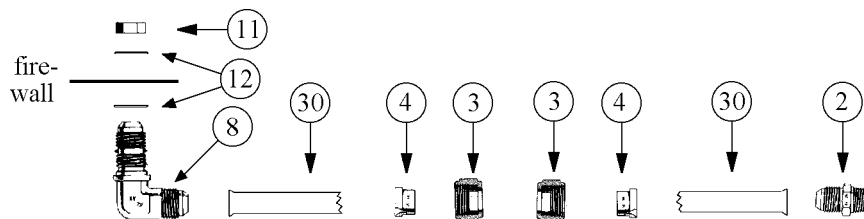

Fittings and washers

- 1 AEROQUIP 816-4D
PN: PC-00901
- 2 AN816-4D
PN: PC-00159
- 3 AN818-4D
PN: PC-00161
- 4 AN819-4D
PN: PC-00860
- 5 AN822-4D
PN: PC-00155
- 6 AN823-4D
PN: PC-00167
- 7 AN832-4D
PN: PC-00171
- 8 AN833-4D
PN: PC-00173
- 9 AN834-4D
PN: PC-01644
- 10 AN837-4D
PN: PC-00174
- 11 AN924-4D
PN: PC-00178
- 12 AN960-C716
PN: PC-00810

Hoses

- 20 AEROQUIP 701-4
PN: PC-00910

Tubes

- 30 alu tube 5052-0, Ø1/4 inch
PN: PC-00123

*Brake Lines
 Figure 5, Sheet 2*

I M P O R T A N T

Test brakes after maintaining the brake system. Actuated brakes shall keep the aircraft standing with engine running at 1.800 rpm and maximum propeller angle of attack. With applied brakes and powersetting above 1800 rpm the wheels may slide on grass.

N O T E

For further information concerning main wheels and brakes refer to Cleveland Wheels and Brakes Maintenance Manual.

32-45-00

MAINTENANCE PRACTICES

32-45-01

Master Cylinder

Removal/Installation

- 1 Drain the brake system.
- 2 Disconnect the fuel lines.
- 3 Fix the master cylinder spring using a mounting aid as shown in Figure 6 (Cleveland master cylinder only).
- 4 Remove the attachment bolts.
- 5 Remove the master cylinder.
- 7 Remove mounting aid (Cleveland only).
- 6 Install in reverse sequence of removal.

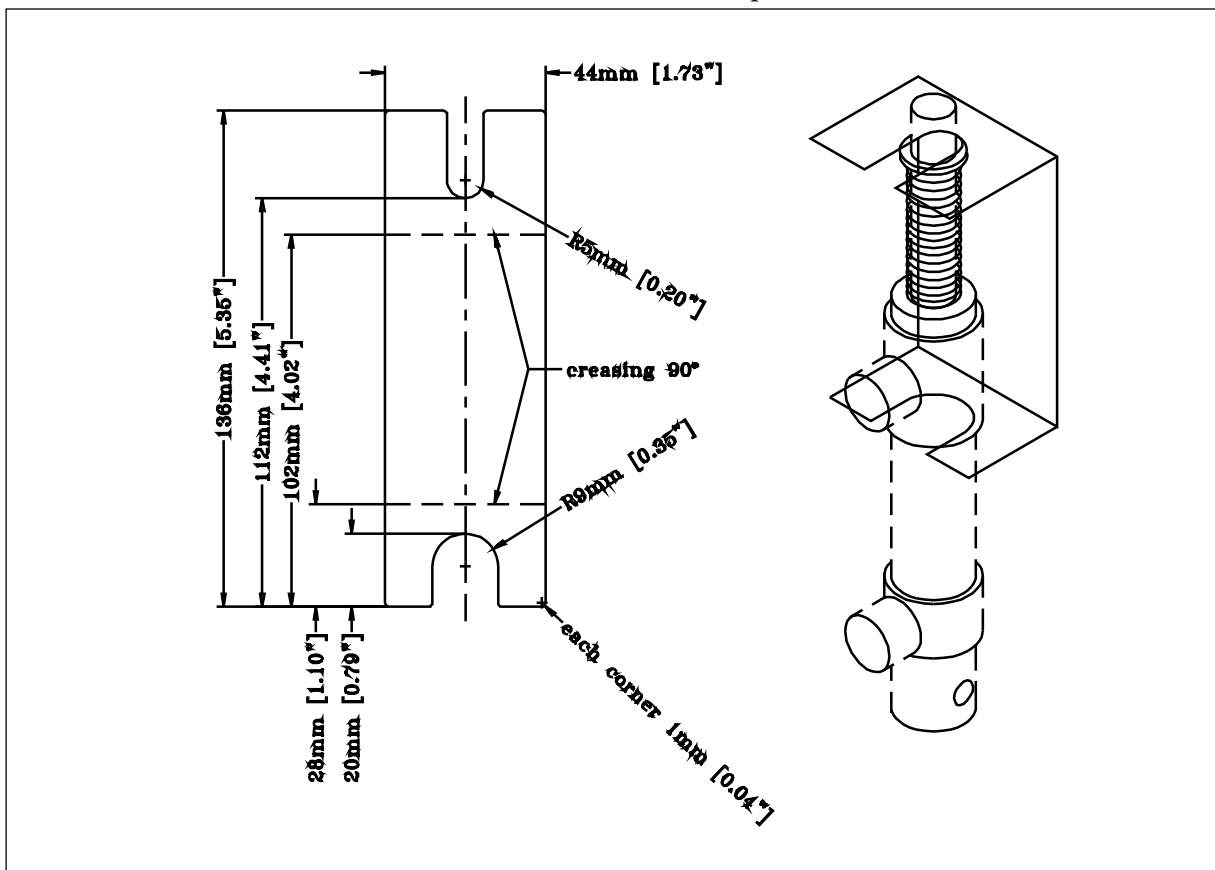

Master Cylinder Mounting Aid
Figure 6