

INFORMATION MANUAL

EXTRA 300S

MANUFACTURER

EXTRA Flugzeugproduktions- und Vertriebs- GmbH
Flugplatz Dinslaken
46569 Hünxe, Federal Republic of Germany

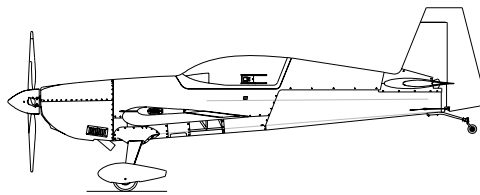

WARNING

This is an Information Manual and may be used for general purposes only.

This Information Manual is not kept current.

It must not be used as a substitute for the official FAA Approved Pilot's Operating Handbook required for operation of the airplane.

Left blank intentionally

MAIN TABLE OF CONTENTS

<i>Section</i>	<i>Page</i>
0 PUBLICATION GUIDANCE	0-1
1 GENERAL	1-1
2 LIMITATIONS	2-1
3 EMERGENCY PROCEDURES	3-1
4 NORMAL PROCEDURES	4-1
5 PERFORMANCE	5-1
6 WEIGHT AND BALANCE AND EQUIPMENT LIST	6-1
7 DESCRIPTION AND OPERATION OF AIRCRAFT AND SYSTEMS	7-1
8 HANDLING, SERVICING AND MAINTENANCE	8-1
9 SUPPLEMENTS	9-1

THIS HANDBOOK SHALL ALWAYS BE CARRIED ON BOARD DURING FLIGHT.

PILOTS OPERATING HANDBOOK PREPARED
BY:

EXTRA Flugzeugproduktions- und Vertriebs- GmbH

THIS MANUAL IS FURNISHED TO
THE CIVIL AVIATION AUTHORITIES
AS A PART OF THE CERTIFICATION-
MATERIAL FOR THIS MODEL.

SECTION 0

PUBLICATION GUIDANCE

Table of Contents

<i>Paragraph</i>		<i>Page</i>
1	INTRODUCTION	0-3
2	NOTES	0-3
3	WARNINGS, CAUTIONS AND NOTES	0-4
4	LOG OF EFFECTIVE PAGES	0-5

Left blank intentionally

1 INTRODUCTION

This handbook contains 10 sections, and includes the material required to be furnished to the pilot by FAR Part 23 . It also contains supplementary data supplied by EXTRA Flugzeugproduktions- und Vertriebs- GmbH .

2 NOTES

- 2.1 This Flight Manual applies only to the aircraft whose nationality and registration marks are noted on the title page.
- 2.2 It is the responsibility of the pilot to be familiar with the contents of this Flight Manual including revisions and any relevant supplements.
- 2.3 Pages of this Airplane Flight Manual must not be exchanged and no alterations of or additions to the approved contents may be made without the EXTRA Flugzeugproduktions- und Vertriebs- GmbH/LBA approval. The editor has the copyright of this Flight Manual and is responsible for edition of revisions/amendments and supplements.
- 2.4 Amendments, which affect the airworthiness of the aircraft will be announced in the publication Lufttüchtigkeitsanweisung (airworthiness directive) issued by LBA, Luftfahrt-Bundesamt, or by the manufacturer EXTRA Flugzeugproduktions- und Vertriebs- GmbH. The owner is responsible for incorporating prescribed amendments and should make notes about these on the records of amendments.
- 2.5 Should this Flight Manual get lost, inform EXTRA Flugzeugproduktions- und Vertriebs- GmbH, Dinslaken 46569 Hünxe, Federal Republic of Germany.
- 2.6 Should this Flight Manual be found, kindly forward it to the civil board of aviation in the country the aircraft is registered.

3 WARNINGS, CAUTIONS AND NOTES

The following definitions apply to Warnings, Cautions, and Notes:

WARNING

=> Operating procedures, techniques, etc which could result in personal injury or loss of life if not carefully followed.

CAUTION

=> Operating procedures, techniques, etc , which could result in damage to equipment if not carefully followed.

NOTE

=> An operating procedures, technique, etc. which is considered essential to emphasize.

"Shall, "Will", "Should" and "May"

The words "shall" or, "will" shall be used to express a mandatory requirement The word "should" shall be used to express nonmandatory provisions The word "may" shall be used to express permissible.

4 LOG OF EFFECTIVE PAGES

Dates of issue for original and revised pages:

Original 13. March 1993

Revision No. 1 6. October 1994

Revision No. 2 26. June 1997

Edition No. 2 20. April 2002

Rev. No. 1, 2nd Ed. 31. January 2006

Rev. No. 2, 2nd Ed. 20. September 2006

Date and sign of approval:

LBA approved 19. March 1993

LBA approved 24. January 1995

LBA approved 27. August 1997

LBA approved 30. October 2002

EASA Approval N° EASA.A.A.01169

Date of Approval 8. March 2006

EASA Approval N° EASA.A.A.01319

Date of Approval 20. November 2006

LOG OF EFFECTIVE PAGES (cont.)

Page	Date	Page	Date
Title	31. January 2006	6-12 thru 6-13	20. September 2006
i	20. April 2002	6-14	31. January 2006
ii	31. January 2006	7-1	31. January 2006
0-1 thru 0-2	20. April 2002	7-2	20. April 2002
0-3	31. January 2006	7-3	31. January 2006
0-4	20. April 2002	7-4 thru 7-7	20. April 2002
0-5 thru 0-6	20. September 2006	7-8 thru 7-12	31. January 2006
1-1	31. January 2006	7-13 thru 7-14	20. April 2002
1-2	20. April 2002	8-1 thru 8-4	20. April 2002
1-3 thru 1-5	31. January 2006	9-1	31. January 2006
1-6 thru 1-8	20. April 2002	9-2	20. April 2002
2-1	31. January 2006	9-3	31. January 2006
2-2 thru 2-3	20. April 2002	9-4	20. April 2002
2-4 thru 2-6	31. January 2006	901-1 thru 901-4	20. April 2002
2-7	20. September 2006	902-1 thru 902-4	20. April 2002
2-8	31. January 2006	903-1 thru 903-10	20. April 2002
2-9	20. September 2006	904-1 thru 904-2	20. April 2002
2-10	31. January 2006	904-3 thru 904-4	31. January 2006
2-11	20. April 2002	904-5 thru 904-6	20. April 2002
2-12	20. September 2006	905-1 thru 905-6	20. April 2002
2-13	31. January 2006	906-1 thru 906-6	20. April 2002
2-14	20. April 2002	907-1 thru 907-6	20. April 2002
3-1 thru 3-4	20. April 2002	908-1	20. September 2006
3-5	31. January 2006	908-2	20. April 2002
3-6	20. April 2002	908-3 thru 908-8	20. September 2006
3-7	31. January 2006	909 thru 911	reserved
3-8	20. April 2002	912-1 thru 912-8	31. January 2006
4-1	31. January 2006	913-1 thru 913-8	31. January 2006
4-2 thru 4-7	20. April 2002	914-1 thru 914-6	31. January 2006
4-8	31. January 2006	915-1 thru 915-8	31. January 2006
4-9 thru 4-12	20. April 2002	916-1 thru 916-6	31. January 2006
5-1 thru 5-14	20. April 2002	917-1 thru 917-8	31. January 2006
6-1 thru 6-2	20. April 2002	918-1 thru 918-6	31. January 2006
6-3	31. January 2006	919-1 thru 919-8	31. January 2006
6-4 thru 6-9	20. April 2002	920-1 thru 920-10	31. January 2006
6-10 thru 6-11	31. January 2006		

SECTION 1

GENERAL

Table of Contents

<i>Paragraph</i>		<i>Page</i>
1.0	DESCRIPTION	1-3
1.1	SPECIFICATION OF CLASS	1-3
1.2	MANUFACTURER	1-3
1.3	TECHNICAL DATA	1-3
1.3.1	3-View Drawing	1-3
1.3.2	Main Data	1-4
1.3.3	Wing	1-4
1.3.4	Horizontal Tail	1-4
1.3.5	Elevator	1-4
1.3.6	Vertical Tail	1-4
1.3.7	Rudder	1-4
1.4	ENGINE	1-5
1.5	PROPELLER	1-5
1.5.1	Exhaust Systems (Optional)	1-5
1.6	FUEL	1-5
1.7	OIL	1-5
1.8	LOADING	1-6
1.9	TERMINOLOGY	1-6
1.10	SECONDARY TERMINOLOGY	1-7

Left blank intentionally

1.0 DESCRIPTION

This description belongs to aircraft type EXTRA 300/S with nationality and registration marks:



Manufacturing

The airframe is built of tig-welded steel-tube construction. Wings, rudder and landing gear are manufactured of composite material.

The aircraft is a one-seater.

1.1 SPECIFICATION OF CLASS

The aircraft is certified in normal and acrobatic category.
LBA - Certificate No. 1086.

1.2 MANUFACTURER

Manufacturer EXTRA Flugzeugproduktions- und Vertriebs- GmbH, Flugplatz Dinslaken
46569 Hünxe, Federal Republic of Germany.

1.3 TECHNICAL DATA

1.3.1 3-View Drawing

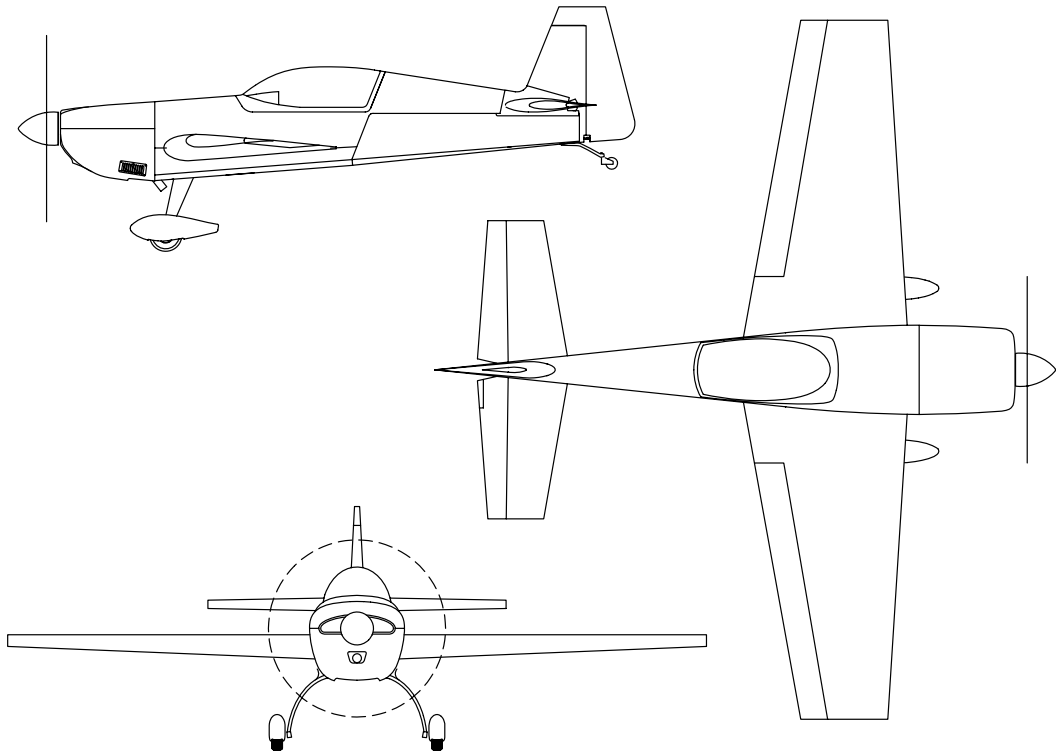

1.3.2 Main Data

- Length	6,65 m (21,82 ft)
- Height	2,62 m (8,60 ft)
- Span	7,50 m (24,61 ft)
- Wheel-base	1,80 m (5,91 ft)
- Wheel-track	4,75 m (15,58 ft)

1.3.3 Wing

- Wing span	7,5 m (24,61 ft)
- Wing-area	10,44 m ² (112,38 ft ²)
- Airfoil	Root: MA 15 S. Tip: MA 12 S
- Chord	Root: 1,85 m (6,07 ft) Tip: 0,93 m (3,05 ft)
- MAC	1,44 m (4,72 ft)
- Aileron area	2 x 0,830 m ² (2 x 8,93 ft ²)
- Aileron deflection	± 30°, tolerance ± 2°

1.3.4 Horizontal Tail

- Span	3,20 m (10,50 ft)
- Area	2,56 m ² (27.56 ft ²)
- Airfoil	Wortmann FX 71-L-150/30

1.3.5 Elevator

- Area	0,77 m ² (8,29 ft ²)
- Elevator-deflection	up 26°; down 26°; tolerance ± 2°
- Trim-tab-deflection	± 15°, tolerance ± 2°

1.3.6 Vertical Tail

- Area	1,39 m ² (14,96 ft ²)
- Airfoil	Wortmann FX 71-L-150/30

1.3.7 Rudder

- Area	0,51 m ² (5,49 ft ²)
- Rudder deflection	left 30°; right 30°; tolerance ± 2°

1.4 ENGINE

Manufacturer Textron-Lycoming Williamsport Plant PA 17701 USA.

- a) Type Lycoming AEIO-540-L1B5
- b) Type Lycoming AEIO-540-L1B5D

Rated power: 300HP @ 2700RPM, 270HP @ 2400RPM

1.5 PROPELLER

Manufacturer MT-Propeller Entwicklung GmbH, Federal Republic of Germany.

- a) Type MTV-9-B-C/C 200-15 3-blade constant speed.
- b) Type MTV-14-B-C/C 190-17 4-blade constant speed.

1.5.1 Exhaust Systems (Optional)

Manufacturer Gomolzig Flugzeug- und Maschinenbau GmbH, Federal Republic of Germany

Exhaust Silencer for standard system: PN: EA 300 NSD, GO3-606500.

Complete 6 in 1 System with integrated Silencer: PN: EA 300-606000

1.6 FUEL

Fuel type AVGAS 100/100 LL (for alternate fuel grades see later issues of Textron Lyc. S.I. No 1070)

Minimum 100/130 octane. Maximum 115/145 octane

Total fuel volume 171 litres (45,1 US Gallon)

- Wingtanks (2 x 60 l) 120 litres (31.7 US Gallon)
- Center tank 42 litres (11,1 US Gallon)
- Acro tank 9 litres (2,3 US Gallon)

Usable fuel in the system 169 litres (44,6 US Gallon)

Usable fuel for acrobatic (acro and center tank) 49 litres (12.9 US Gallon)

1.7 OIL

Maximum sump capacity: 16 qts.

Minimum sump capacity: -Acrobatics: 12 qts.
 -Normal: 9 qts.

Average ambient air temperature	Mil-L6082 grades	Mil-22851 ashless dispersant grades
All temperatures	----	SAE 15W50 or 20W50
> 27°C (80°F)	SAE 60	SAE 60
> 16°C (60°F)	SAE 50	SAE 40 or 60
- 1°C til 32°C (30°F - 90°F)	SAE 40	SAE 40

1.7 OIL (Continuation)

Average ambient air temperature	Mil-L6082 grades	Mil-22851 ashless dispersant grades
- 18°C til 21°C (0°F - 70°F)	SAE 30	SAE 30,40 or 20W40
- 18°C til 32°C (0°F - 90°F)	SAE 20W50	SAE 20W50 or 15W50
< -12°C (10°F)	SAE 20	SAE 30 or 20W30

(single or multi - viscosity aviation grade oils see latest issue of Textron Lyc. S.I. No. 1014)

1.8 LOADING

Wing loading	88,1 kg/m ² 78,5 kg/m ²	Normal Acrobatic
Power loading	3,07 kg/hp 2.73 kg/hp	Normal Acrobatic

1.9 TERMINOLOGY

Air Speeds

CAS	Calibrated Air Speed. CAS is the same as TAS (True Air Speed) in std. atmospheric condition at sea level
KCAS	Calibrated speed in knots
GS	Ground speed
IAS	Indicated air speed
KIAS	Indicated speed in knots
TAS	True air speed. It's the same as CAS compensated for altitude, temperature and density
VA	Maneuvering speed
VNE	Never exceed speed
VNO	Maximum structural crusing speed
VS	Stalling speed or minimum steady flight speed
VX	Best angle-of-climb speed
VY	Best rate-of-climb speed

Meteorological terminology

ISA	International standard atmospheric condition
OAT	Outside air temperature

1.10 SECONDARY TERMINOLOGY

FPM	Feet/minute
ft	Feet = 0.3048 m
inch	inch = 2,54 cm
m	Meter
L	Litres
Gal	US gallon = 3.79 litres
Qts	US quart = 0.946 litres
hp	Horse power (english)
h	Hour
kts	Knots (NM/h) = 1.852 kilometer per hour
Lbs	English pound = 0.4536 kg
hPA	hekto Pascal
IN HG	Inches of mercury
MP	Manifold pressure
PA	Pressure altitude (ft)
NM	Nautical miles = 1.852 km
RPM	Revolutions per minute
CG	Center of gravity
Arm	Arm is the horizontal distance from reference datum
Moment	is the product of weight of an item multiplied by its arm.

Left blank intentionally

SECTION 2

LIMITATIONS

Table of Contents

<i>Paragraph</i>		<i>Page</i>
2.1	GENERAL	2-3
2.2	AIR SPEED (IAS)	2-3
2.3	CROSS-WIND COMPONENT	2-3
2.4	ENGINE	2-3
2.4.1	Fuel	2-4
2.4.2	Engine Limitations	2-4
2.5	PROPELLER	2-5
2.6	WEIGHT LIMITS	2-5
2.7	WEIGHT AND C.G. ENVELOPE	2-5
2.7.1	Normal Flight	2-5
2.7.2	Acrobatic Flight	2-5
2.8	ACROBATIC MANEUVERS	2-5
2.8.1	Normal Flight	2-5
2.8.2	Acrobatic Flight	2-6
2.9	LOAD FACTOR	2-7
2.9.1	Normal Flight	2-7
2.9.2	Acrobatic Flight	2-7
2.10	KINDS OF OPERATIONAL LIMITS	2-7
2.11	STRUCTURAL TEMPERATURE/COLOUR LIMITATION	2-7
2.12	MAXIMUM OPERATING ALTITUDE	2-7
2.13	TIRE PRESSURE	2-7
2.14	MARKINGS AND PLACARDS	2-7
2.14.1	Aircraft Identity Placard	2-7
2.14.2	Operating Placards	2-8
2.14.3	Instrument Markings	2-11
2.15	KINDS OF OPERATION EQUIPMENT LIST	2-12
2.16	NOISE LEVEL	2-13

Left blank intentionally

SECTION 2

LIMITATIONS

2.1 GENERAL

This section includes operating limitations, instrument markings, and basic placards necessary for the safe operation of the aircraft, its engine, standard systems, and standard equipment. The limitations included in this section have been approved by the Luftfahrt-Bundesamt (LBA). Observance of these operating limitations is required by national aviation regulations.

NOTE

In case of an aircraft is equipped with specific options additional information required for safe operation will be contained in Section 9 "Supplements".

Instrument markings and placards are provided for the acrobatic category only; for normal category refer to corresponding limitations. This aircraft is certified under LBA-Flugzeug-kennblatt Nr. 1086, Type Certification Data Sheet (T.C.D.S.).

Any exceedance of given limitations have to be reported by the pilot and considered by corresponding maintenance or inspection procedure according to *SERVICE MANUAL EA 300/S*.

2.2 AIR SPEED (IAS)

Never Exceed Speed	VNE	220 knots
Max. Structural Cruising Speed	VNO	158 knots
Maneuver speed (Normal)	VA	140 knots
Maneuver speed (Acro)	VA	158 knots

2.3 CROSS-WIND COMPONENT

Max. demonstrated cross-wind component for take-off and landing 15 knots.

2.4 ENGINE

Engine-type Textron-Lycoming AEIO-540-L1B5 / AEIO-540-L1B5D with rated maximum 300 HP @ 2700 RPM.

2.4.1 FUEL

Minimum grade aviation gasoline : 100/100LL for alternate fuelgrades see latest revision of Lyc. S.I. No. 1070.
 Total fuel capacity 171 liters (45.1 US Gallon).
 Usable fuel capacity 169 liters (44.6 US Gallon).
 For acrobatic flight wing tanks must be empty.
 Total fuel capacity for acrobatic 51 liters (13.4 US Gallon) in acro tank.
 Usable fuel capacity for acrobatic 49 liters (12.9 US Gallon) in acro tank.

2.4.2 ENGINE LIMITATIONS

a) Tachometer gauge

-Max. Take-Off (max 5 min)	2700 RPM
-Max. Continuous	2400 RPM

NOTE:

If not stated somewhere else (refer to section: 4.12 Acrobatic Maneuvers) the aircraft may be operated in acrobatic maneuvers up to 2700 RPM.

b) Oil-temperature gauge

-Max	245°F
------	-------

c) Oil capacity

-Maximum sump capacity:		16 qts.
-Minimum sump capacity:	-Acrobatic:	12 qts.
	-Normal:	9 qts.

d) Oil pressure

-Minimum Idling	25 Psi
-Normal	55 - 95 Psi
-Starting, Warm up Taxi and Take-Off	115 Psi

CAUTION

It is normal for the oil pressure to "flicker" from 10 to 30 psi when going from upright to inverted flight. During knife edge flights and zero-g flights oil pressure may drop and the oil system may not scavenge resulting in engine failure or damage if flight is prolonged. Knife edge and zero-g flight should not exceed 10 seconds.

WARNING

If oil pressure drops to 0 psi the propeller pitch changes automatically to coarse (high) pitch with a corresponding decrease in RPM. Apply positive g to avoid engine stoppage.

e) Fuel pressure

-Max	40 Psi
-Min	18 Psi
-Min Idle	12 Psi

f) Cylinder head temperature

-Max 500°F

2.5 PROPELLER

MT-Propeller Entwicklung GmbH, Federal Republic of Germany

a) Type MTV-9-B-C-/C 200-15

b) Type MTV-14-B-C-/C 190-17

-Max. Take-Off (max 5 min) 2700 RPM
-Max. Continuous 2400 RPM *

NOTE *

If not stated otherwise (refer to section: 4.12 Acrobatic Maneuvers) the aircraft may be operated in acrobatic maneuvers up to 2700 RPM.

2.6 WEIGHT LIMITS

Max. allowed empty weight:	
-Normal category	711 kg (1567 lbs)
-Acrobatic category	697 kg (1536 lbs)
Max. allowed T/O weight:	
-Normal category	920 kg (2028 lbs)
-Acrobatic category	820 kg (1808 lbs)
Max allowed landing weight:	920 kg (2028 lbs)

2.7 WEIGHT AND C.G. ENVELOPE

Vertical reference = fire-wall.
Horizontal reference = upper longerons in cockpit.

2.7.1 NORMAL FLIGHT

Max T/O Weight:	forward C.G.	rear C.G.
920 kg (2028 lbs)	48.9 cm (19,3")	71,4 cm (28,1")
(and below)		

2.7.2 ACROBATIC FLIGHT

Max T/O weight:	forward C.G.	rear C.G.
820 kg (1808 lbs)	48.9 cm (19,3")	71,4 cm (28,1")
(and below)		

2.8 ACROBATIC MANEUVERS

2.8.1 NORMAL FLIGHT

All acrobatic maneuvers are prohibited except stall, chandelle, lazy eight and turns up to 60 degrees bank angle.

2.8.2 ACROBATIC FLIGHT

The plane is designed for unlimited acrobatics (wing tanks must be empty). Inverted flight maneuvers are limited to max 4 min. Recommended basic maneuver entry speeds are listed in the following list:

Maneuvers	Recommended entry speeds		Symbol	Remarks
	min KIAS	max KIAS		
Segment: Horizontal Line	V_s	V_{ne}		
45° climbing	80	V_{ne}		
90° up	158	V_{ne}		
45° diving	V_s	V_{ne}		reduce throttle
90° diving	V_s	V_{ne}		reduce throttle
1/4 Loop climb.	100	190		
Looping	100	190		
Stall turn	100	190		
Aileron roll	80	158		full deflection
Snap roll	80	140		
"Tail slide"	100	190		
Spin	V_s			
Inverted spin	V_s			
Knife edge	>150			< 10 s
Inverted Flight	> V_s	190		< 4 min

CAUTION

Particular caution must be exercised when performing maneuvers at speeds above V_a (158 KIAS). Large or abrupt control inputs above this speed may impose unacceptably high loads which exceed the structural capability of the aircraft.

NOTE

For Acrobatic Maneuvers see Section 4. All maneuvers can be performed in positive and negative flight attitude.

2.9 LOAD FACTOR

2.9.1 NORMAL FLIGHT

+ 6 g / -3 g for MTOW 920 kg (2028 lbs)

2.9.2 ACROBATIC FLIGHT

+ 10 g / - 10 g for MTOW 820 kg (1808 lbs)

2.10 KINDS OF OPERATIONAL LIMITS

Only VFR flights at day are allowed. The A/C may be operated at OAT from -20°C (-4°F) to +44°C (111°F). Below temperatures of -10°C (+14°F) the oil vent line must be modified by the low temperature kit (breather line). Flight in known icing-conditions is prohibited. Smoking is prohibited.

2.11 STRUCTURAL TEMPERATURE/COLOUR LIMITATION

Structure is qualified up to 72°C (161,6°F). Structure temperatures (composite) above 72°C (161,6°F) are not permitted. Not to exceed this temperature limit, color specification for composite structure (manufacturer document EA-03205.19) has to be complied with.

2.12 MAXIMUM OPERATING ALTITUDE

Max. certified operating altitude is 16000 ft MSL (4877 m)

2.13 TIRE PRESSURE

The tire pressure is 2800 hpa (40,2 psi).

2.14 MARKINGS AND PLACARDS

2.14.1 AIRCRAFT IDENTITY PLACARD

○ MANUFACTURER:
EXTRA FLUGZEUGBAU GMBH
MODEL: EA 300/S
SERIAL NUMBER: _____
○ TC-NUMBER: ○

or

○ EXTRA
FLUGZEUGPRODUKTIONS-
UND VERTRIEBS-GMBH
MODEL: EA 300/S
SERIAL NUMBER: _____
○

○ TC-NUMBER: A67EU ○

2.14.2 OPERATING PLACARDS

V_A = 158 KTS (ACRO)
V_A = 140 KTS (NORMAL) — (near airspeed indicator)

THE MARKINGS AND PLACARDS INSTALLED IN THIS AIRPLANE CONTAIN OPERATING LIMITATIONS WHICH MUST BE COMPLIED WITH WHEN OPERATING THIS AIRPLANE IN THE ACROBATIC CATEGORY. OTHER LIMITATIONS WHICH MUST BE COMPLIED WITH WHEN OPERATING THIS AIRPLANE IN THIS CATEGORY OR IN THE NORMAL CATEGORY ARE CONTAINED IN THE AIRPLANE FLIGHT MANUAL. APPLICABLE RPM LIMITATION MUST BE OBSERVED — (left side under canopy frame)

THIS AIRPLANE IS CERTIFICATED FOR VFR, DAY OPERATION. OPERATION UNDER KNOWN ICING CONDITIONS PROHIBITED. — (on the instrument panel)

F U E L
AVGAS 100/100 LL — (near each filler cap)

O I L — (on the seperate hatch / upper cowling)

FUEL SELECTOR => **ACRO & CENTER**
49 L USABLE
(12.9 US GAL)

WING TANK
120 L
USABLE
(31,7 US GAL)

O F F

— (on right aux. spar hardpoint)

NOSE DOWN <= NEUTRAL => NOSE UP
TRIM — (near trim lever at the right side in the cockpit)

WING TANK
MUST BE EMPTY FOR ACROBATICS — (on the insrument panel under fuel capacity indicator)

ACRO & CENTER TANK
SHOWS "ZERO" IN LEVEL FLIGHT BELOW 11.6 L (3 US GAL.)
UNUSABLE FUEL: 2 L (0.5 US GAL.)

**THE REMAINING FUEL IN LEVEL FLIGHT
CANNOT BE USED SAFELY
WHEN INDICATOR READS "ZERO".**

(on the instrument panel
under the acro & center tank
fuel capacity indicator)

**ACROBATIC: ± 10 G
MTOW 820 KG (1808LBS)**

(in cockpit)

**NORMAL : + 6 G/- 3 G
MTOW 920 kg (2028 LBS)
ACROBATICS INCL. SPIN NOT APPROVED**

**OFF
BOOST PUMP**

(under pump switch on the instrument panel)

NO SMOKING

(on canopy frame)

**USE OF HEADSET IS REQUIRED
USE OF PARACHUTE IS RECOMMENDED**

(on the right side of
instrument panel)

LOW RPM <= PROP => HIGH RPM

(on RPM control unit in the
rear cockpit)

RICH <= MIXTURE => LEAN

(on mixture control unit in the
rear cockpit)

CLOSE <= THROTTLE => OPEN

(near throttle control in both
cockpits)

**CANOPY LOCK
LOCK <= O => UNLOCK <= O => LOCK**

(near canopy locking handles
of each cockpit)

**V E N T
O P E N**

(near the eyeball-type adjustable vents)

CAUTION

Particular caution must be exercised when performing maneuvers at speeds above Va (158 KIAS). Large or abrupt control inputs above this speed may impose unacceptably high loads which exceed the structural capability of the aircraft.

(in cockpit)

APPROVED ACROBATIC MANEUVERS AND RECOMMENDED ENTRY AIRSPEEDS		
Maneuvers	speeds	
	min KIAS	max KIAS
Segment: horizontal Line	V_s	V_{ne}
45° climbing	80	V_{ne}
90° up	158	V_{ne}
45° diving	V_s	V_{ne}
90° diving	V_s	V_{ne}
1/4 Loop climb.	100	190
Looping	100	190
Stall turn	100	190
Aileron roll	80	158
Snap roll	80	140
"Tail-slide"	100	190
Spin	V_s	
Inverted spin	V_s	
Inverted flight Less than 4 min	$> V_s$	190
Knife edge Less than 10 s	>150	

(in cockpit)

NO BAGGAGE

(on Lexan cover aft pilot's seat, if installed)

2.14.3 INSTRUMENT MARKINGS

AIRSPEED INDICATOR

green arc	60 Kts	-	158 Kts
yellow arc	158 Kts	-	220 Kts
red line	220 Kts		

OIL PRESSURE INDICATOR

red line	25 Psi		
yellow arc	25 Psi	-	55 Psi
green arc	55 Psi	-	90 Psi
yellow arc	90 Psi	-	100 Psi
red line	100 Psi		

OIL TEMPERATURE INDICATOR

yellow arc	< 140 °F		
green arc	140 °F	-	210 °F
yellow arc	210 °F	-	245 °F
red line	245 °F		

CYLINDERHEAD TEMPERATURE INDICATOR

yellow arc	< 150 °F		
green arc	150 °F	-	435 °F
yellow arc	435 °F	-	500 °F
red line	500 °F		

RPM INDICATOR

green arc	700 RPM	-	2400 RPM
yellow arc	2400 RPM	-	2700 RPM
red line	2700 RPM		

G - METER

green arc	- 5 g	-	+ 8 g
yellow arc	+ 8 g	-	+ 10 g
red line	+ 10 g		

FUEL FLOW INDICATOR

green arc	0 gal / h	-	35 gal / h
red radial	35 gal / h		

MANIFOLD PRESSURE INDICATOR

green arc	10 " Hg - 25 " Hg
yellow arc	25 " Hg - 29.5 " Hg
red radial	29.5 " Hg

2.15 KINDS OF OPERATION EQUIPMENT LIST

The aircraft may be operated in day-VFR when the appropriate equipment is installed and operable. Flying under known icing conditions is prohibited.

The following equipment list identifies the systems and equipment upon which type certification for each kind of operation was predicated. The following systems and items of equipment must be installed and operable for the particular kind of operation indicated.

	NORMAL	ACROBATIC
COMMUNICATION		
1. Transceiver-VHF	1	1
ELECTRICAL POWER		
1. Battery	1	1
2. Alternator	1	1
3. Amperemeter	1	1
FLIGHT CONTROL SYSTEM		
1. Elevator-trim control	1	1
2. Stall warner	1	1
FUEL		
1. Boost pump	1	1
2. Fuel quantity indicator	2	2
3. Manifold pressure	1	1
4. Fuel flow indicator	1	1
5. Fuel pressure	0	0
LIGHT		
1. Wing-tip position / strobe light	1	1
NAVIGATION		
1. Altimeter	1	1
2. Airspeed indicator	1	1
3. Mag. direction indicator	1	1
4. OAT indicator	0	0
5. Vertical speed indicator	0	0
6. Turn & bank indicator	0	0

- 7. Artificial horizon
- 8. Directional gyro
- 9. Transponder¹

ENGINE CONTROL

- 1. RPM indicator
- 2. Exhaust gas temperature ind.
- 3. Cylinder head temperature ind.

OIL

- 1. Oil temperature indicator
- 2. Oil pressure indicator

FLIGHT CREW EQUIPMENT

- 1. Parachute
- 2. Seat belt
- 3. Headset

	NORMAL	ACROBATIC
7. Artificial horizon	0	0
8. Directional gyro	0	0
9. Transponder ¹	1	1
ENGINE CONTROL		
1. RPM indicator	1	1
2. Exhaust gas temperature ind.	0	0
3. Cylinder head temperature ind.	0	0
OIL		
1. Oil temperature indicator	1	1
2. Oil pressure indicator	1	1
FLIGHT CREW EQUIPMENT		
1. Parachute	0	*
2. Seat belt	1	1
3. Headset	1	1

NOTE

The zeros (0) used in the above list mean that either the equipment or system, or both were not required for type certification for that kind of operation.

Either equipment or systems in addition to those listed above may be required by the national operating regulations.

The asterisk (*) used in the above list means that latest national aviation regulations must be observed in determining whether the equipment and/or system is required.

According FAR Part 91 „General Operating and Flight Rules" each occupant of an US registered airplane must wear an approved parachute when performing acrobatic maneuvers.

Extra Flugzeugproduktions- und Vertriebs- GmbH considers acrobatics without wearing an approved parachute to be unsafe.

2.16 NOISE LEVEL

The noise level with silencer Gomolzig 606000 (6 in 1) and propeller MTV-14-B-C/C190-17 has been established in accordance with ICAO Annex 16, as 77.3 dB(A)

The noise level with propeller MTV-9-B-C/C200-15 has been established in accordance with FAR 36 Appendix G, as 73.0 dB(A).

No determination has been made by the LBA for the FAA that the noise levels of this airplane are or should be acceptable or unacceptable for operation at, into, or out any airport.

¹) In some airspaces Mode S Elementary Surveillance functionality is required

Left blank intentionally

SECTION 3

EMERGENCY PROCEDURES

Table of Contents

<i>Paragraph</i>		<i>Page</i>
3.0	INTRODUCTION	3-3
3.0.1	General	3-3
3.0.2	General Behaviour In Emergency Situations	3-3
3.1	AIRSPEEDS FOR EMERGENCY OPERATION	3-4
3.2	OPERATIONAL CHECKLIST	3-4
3.2.1	Engine Failure during Take-off Roll	3-4
3.2.2	Engine Failure immediately after Take-off	3-4
3.2.3	Engine Failure during Flight (Restart Process)	3-4
3.2.4	Oil System Malfunction	3-5
3.2.5	Alternator Failure	3-5
3.3	FORCED LANDINGS	3-5
3.3.1	Emergency Landing without Engine Power	3-5
3.3.2	Precautionary Landing with Engine Power	3-5
3.4	FIRES	3-6
3.4.1	During Start on Ground	3-6
3.4.2	If Engine Fails to Start	3-6
3.4.3	Engine Fire in Flight	3-7
3.5	ICING	3-7
3.5.1	Inadvertent Icing Encounter	3-7
3.6	UNINTENTIONAL SPIN	3-7
3.7	MANUAL BAIL-OUT	3-7
3.8	EMERGENCY EXIT AFTER TURN OVER	3-8
3.9	ELEVATOR CONTROL FAILURE	3-8

Left blank intentionally

SECTION 3

EMERGENCY PROCEDURES

3.0 INTRODUCTION

3.0.1 GENERAL

This section contains the checklist and procedures coping with emergencies that may occur. This checklist must be followed in various emergencies to ensure maximum safety for the pilot and/or aircraft.

Thorough knowledge of these procedures will enable the pilot to better cope with an emergency. The steps should be performed in the listed sequence. However the procedures do not restrict the pilot from taking any additional action necessary to deal with the emergency. The procedures contain items classified as critical or noncritical. The critical items are actions that shall be performed immediately to avoid aggravating the emergency.

3.0.2 GENERAL BEHAVIOUR IN EMERGENCY SITUATIONS

In any emergency situation, contact should be established with a ground station as soon as possible after completing the initial corrective action. Include position, altitude, heading, speed, nature of the emergency and pilot's intentions in the first transmission. There after the ground station should be kept informed of the progress of the flight and of any changes or developments in the emergency. Three basic rules apply to most emergencies and should be observed by each aircrew member:

1. Maintain aircraft control
2. Analyze the situation and take proper action
3. Land as soon as possible/as soon as practical

The meaning of "*as soon as possible*" and "*as soon as practical*" as used in this section is as follows:

Land AS SOON AS POSSIBLE (ASAP) = Emergency conditions are urgent and require an immediate landing at the nearest suitable airfield, considering also other factors, such as weather conditions and aircraft mass.

Land AS SOON AS PRACTICAL = Emergency conditions are less urgent and in the aircrews judgement the flight may be safely continued to an airfield where more adequate facilities are available.

3.1 AIRSPEEDS FOR EMERGENCY OPERATION

Stall speed	60 KIAS
Engine failure after take-off	80 KIAS
Best recommended gliding speed (glide angle 1 : 6,2) -Normal cat. (920 kg / 2028 LBS)	90 KIAS
-Acrobatic cat. (820 kg / 1808 LBS)	80 KIAS
Precautionary landing with engine power	80 KIAS
Landing without engine power	80 KIAS
Maximum demonstrated cross wind component	15 Knots

3.2 OPERATIONAL CHECKLIST

3.2.1 ENGINE FAILURE DURING TAKE-OFF ROLL

1. Throttle	IDLE
2. Brakes	APPLY
3. Mixture	IDLE CUT OFF
4. Ignition switch	OFF
5. Master switch	OFF

3.2.2 ENGINE FAILURE IMMEDIATELY AFTER TAKE-OFF

Stall speed 60 KIAS

1. Airspeed	80 KIAS
2. Mixture	IDLE CUT OFF
3. Fuel shutoff valve	OFF (Pull & Turn)
4. Ignition switch	OFF
5. Master switch	OFF
6. Forced landing	PERFORM AS PRACTICABLE

3.2.3 ENGINE FAILURE DURING FLIGHT (RESTART PROCESS)

1. Airspeed	80 KIAS
2. Fuel shutoff valve	CENTER TANK
3. Mixture	RICH
4. Boost pump	ON
5. Ignition switch	BOTH (or START if propeller has stopped)

3.2.4 OIL SYSTEM MALFUNCTION

If oil pressure indicates low:	Apply positive "g"
If oil pressure is not regained than:	
1. Airspeed	80 KIAS
2. Throttle	REDUCE TO IDLE
3. Engine oil temperature	OBSERVE INDICATION
4. Land	ASAP

WARNING

If oil pressure drops to 0 psi the propeller pitch changes automatically to coarse (high) pitch with a corresponding decrease in RPM.

3.2.5 ALTERNATOR FAILURE

An alternator failure is indicated by the red light of the low voltage monitor.
If red light illuminates:

1. Alternator	SWITCH OFF AND ON
2. Low voltage monitor	CHECK INDICATION
3. Red light off	CONTINUE FLIGHT
If red light illuminates again:	
4. Land	AS SOON AS PRACTICAL

3.3 FORCED LANDINGS

3.3.1 EMERGENCY LANDING WITHOUT ENGINE POWER

1. Seat belts, shoulder harnesses	SECURE
2. Airspeed	80 KIAS
3. Mixture	IDLE CUT OFF
4. Fuel shutoff valve	OFF (Pull & Turn)
5. Ignition switch	OFF
6. Master switch	OFF
7. Touchdown	SLIGHTLY TAIL LOW
8. Brakes	OPTIMUM BRAKING

3.3.2 PRECAUTIONARY LANDING WITH ENGINE POWER

1. Seat belt, shoulder harness	SECURE
2. Airspeed	80 KIAS
3. Selected field	FLY OVER, noting terrain and obstructions, then reaching a safe altitude and airspeed
4. Master switch	OFF
5. Touchdown	SLIGHTLY TAIL LOW
6. Ignition switch	OFF
7. Mixture	IDLE CUT OFF
8. Fuel shutoff valve	OFF (Pull & Turn)
9. Brakes	APPLY HEAVILY

3.4 FIRES

3.4.1 DURING START ON GROUND

1. Cranking	CONTINUE to get a start which would suck the flames and accumulated fuel through the air inlet and into the engine.
2. Fuel shutoff valve	OFF (Pull & Turn)
3. Power	1700 RPM for one minute.
4. Engine	SHUT DOWN
5. After engine stop	ABANDON aircraft and inspect for damage
6. Fire	EXTINGUISH using fire extinguisher if available

WARNING

Do not open engine compartment access doors while engine is on fire!

3.4.2 IF ENGINE FAILS TO START

1. Cranking	CONTINUE
2. Throttle	FULL OPEN
3. Mixture	IDLE CUT OFF
4. Fuel shutoff valve	OFF (Pull & Turn)
If fire is extinguished	
5. Master switch	OFF
6. Ignition switch	OFF
7. Engine compartment	INSPECT

3.4.3 ENGINE FIRE IN FLIGHT

- | | |
|-----------------------------|---|
| 1. Mixture | IDLE CUT OFF |
| 2. Fuel shutoff valve | OFF (Pull & Turn) |
| 3. Master switch | OFF |
| 4. Airspeed | 100 KIAS, find your
airspeed/attitude
which will keep the
fire away from the cockpit |
| 5. Land as soon as possible | |

3.5 ICING

3.5.1 INADVERTED ICING ENCOUNTER

1. Turn back or change altitude to obtain an outside temperature that is less conductive to icing.
2. Plan a landing at the nearest airfield. With extremely rapid ice build-up select a suitable "off airport" landing field.

3.6 UNINTENTIONAL SPIN

Refer to section 4 (Normal Procedures) acrobatic maneuver, spin recovery

3.7 MANUAL BAIL-OUT

When in an emergency situation that requires abandoning the aircraft and while wearing a parachute, which is at least strongly recommended for acrobatics:

- Reduce speed to 100 Kts if possible
- Pull mixture to lean
- Open canopy (the low pressure over the canopy in normal flight will flip the canopy fully open immediately)
- Take off headset
- Open seat belt
- Leave airplane to the left side
- Try to avoid wing and tail
- Open parachute

3.8 EMERGENCY EXIT AFTER TURN OVER

- | | |
|------------------------|-------------------|
| 1. Master switch | OFF |
| 2. Fuel shutoff valve | OFF (Pull & Turn) |
| 3. Seat belts | OPEN |
| 4. Parachute harnesses | OPEN |
| 5. Canopy handle | PULL TO OPEN |

WARNING

If canopy fails to open break the canopy.

- | | |
|-------------|---------------|
| 6. Aircraft | EVACUATE ASAP |
|-------------|---------------|

3.9 ELEVATOR CONTROL FAILURE

In case of elevator control failure the aircraft can be flown with the elevator trim.

In this case trim nose up to the desired speed and control horizontal flight or descend with engine power.

For landing trim nose up and establish a shallow descend by adjusting throttle. To flair the plane gently increase power to bring the nose up to landing attitude.

SECTION 4

NORMAL PROCEDURES

Table of Contents

<i>Paragraph</i>		<i>Page</i>
4.0	GENERAL	4-3
4.0.1	Airspeeds for Normal Operation	4-3
4.0.2	Checklist and Procedures	4-3
4.1	PREFLIGHT INSPECTION	4-4
4.1.1	Exterior Inspection Illustration	4-4
4.1.2	General	4-4
4.3	STARTING PROCEDURES	4-6
4.3.1	Cold Engines	4-6
4.3.2	Hot Engines	4-6
4.4	TAXIING THE AIRCRAFT	4-6
4.5	TAKE-OFF PROCEDURE	4-7
4.5.1	Before Take-off	4-7
4.5.2	Take-off	4-7
4.6	CLIMB	4-7
4.7	CRUISE	4-7
4.8	LANDING PROCEDURES	4-8
4.8.1	Descent	4-8
4.8.2	Approach	4-8
4.8.3	Before Landing	4-8
4.8.4	Normal Landing	4-8
4.9	GO-AROUND	4-9
4.10	SHUTDOWN	4-9
4.11	LEAVING THE AIRCRAFT	4-9
4.12	ACROBATIC MANEUVERS	4-10
4.12.1	General	4-10
4.12.2	Maneuvers	4-10
4.12.3	Spin	4-12

Left blank intentionally

SECTION 4

NORMAL PROCEDURE

4.0 GENERAL

4.0.1 AIRSPEEDS FOR NORMAL OPERATION

SPEEDS IN KIAS

CATEGORY	ACRO	NORMAL
Start:		
-Rotating Speed	60	65
Climb:		
-Vx	87	93
-Vy	96	104
-Recommended Normal Climb Speed	100	110
Max. Cruise Speed	185	185
Landing:		
-Approach	75	80
-On Final	65	70
-Go-Around Speed	90	100
Recommended Airspeed For Flight In Rough Air (maximum)	VA= 158	VA= 140
Max. Demonstrated Cross Wind Component	15 Kts	15 Kts

4.0.2 CHECKLIST AND PROCEDURES

This handbook contains the checklist and procedures to operate the aircraft in normal and acrobatic operation. The pilot should be familiar with all procedures contained in this Pilot's Operating Handbook, which should be carried on board. The pilot has to comply with Checklist for daily check and inspections (see Section 8, Handling, Servicing and Maintenance).

4.1 PREFLIGHT INSPECTION

4.1.1 EXTERIOR INSPECTION ILLUSTRATION

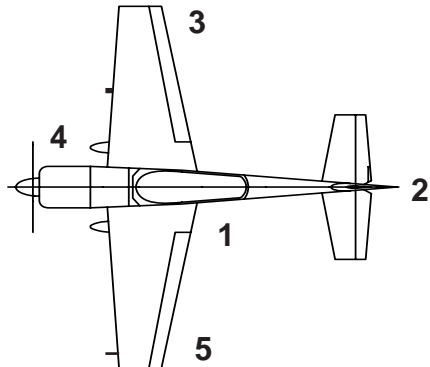

4.1.2 GENERAL

Visually check airplane for general condition during walk around inspection.
Perform exterior check as outlined in the picture above in counterclockwise direction.

4.2 CHECKLIST PROCEDURES

1) Cockpit

- | | |
|--------------------------------|--------------------|
| 1. Pilot's Operating Handbook | (AVAILABLE) |
| 2. Airplane weight and balance | CHECKED |
| 3. Ignition switch | OFF |
| 4. Master switch | ON |
| 5. Fuel quantity indicators | CHECK |
| 6. Master switch | OFF |
| 7. Fuel selector * | ACRO & CENTER TANK |

NOTE *

Although safe operation did not require the use of the tanks in a specific sequence, it is recommended to set fuel selector to "ACRO & CENTER TANK" position!

2) Empennage

- | | |
|--|---|
| 1. All round inspection, canopy, surfaces, stabilizer, elevator, trim rudder and tailwheel | CHECK |
| 2. Horizontal stabilizer attachment bolts | CHECK FOR FREEPLAY BY MOVING THE TIP OF THE HORIZ. STABILIZER UP- AND DOWNWARDS |

3) Right Wing

- | | |
|--|-------|
| 1. Aileron, freedom of movement and security | CHECK |
| 2. Trailing edge | CHECK |
| 3. Fuel tank vent opening (right landing gear) | CHECK |
| 4. Fuel quantity | CHECK |
| 5. Fuel tank filler cap | CHECK |
| 6. Right landing gear, wheel and brake | CHECK |
| 7. Stall warning vane | CHECK |

4) Nose

- | | |
|------------------------------------|---|
| 1. Engine oil dipstick | CHECK |
| 2. Propeller and spinner | CHECK |
| 3. Air inlet | CHECK |
| 4. Acro & center fuel tank drain | DRAIN FOR AT LEAST 4 SECONDS TO CLEAR SUMP OF POSSIBLE WATER;
CHECK CLOSED |
| 5. Wing fuel tank drain | DRAIN FOR AT LEAST 4 SECONDS TO CLEAR SUMP OF POSSIBLE WATER;
CHECK CLOSED |
| 6. Fuel filter drain | DRAIN FOR AT LEAST 4 SECONDS TO CLEAR FILTER OF POSSIBLE WATER;
CHECK CLOSED |
| 7. Exhaust silencer (if installed) | CHECK FOR DAMAGE AND SECURE ATTACHMENT |

5) Left wing

- | | |
|--|--------|
| 1. Left landing gear, wheel and brakes | CHECK |
| 2. Fuel quantity | CHECK |
| 3. Fuel tank filler cap | CHECK |
| 4. Pitot cover | REMOVE |
| 5. Trailing edge | CHECK |
| 6. Aileron, freedom of movement and security | CHECK |

6) Before starting engine

- | | |
|--|-----------------|
| 1. Preflight inspection | COMPLETE |
| 2. Parachute handling briefing | COMPLETE |
| 3. Seat, seatbelts, shoulder harnesses | ADJUST AND LOCK |
| 4. Canopy | CLOSE AND LOCK |

CAUTION

Handles of the canopy lock mechanism must be in the most opposite position indicated with a red line on the canopy frame. Check gap between canopy frame and fuselage fairing!

- | | |
|--------------------------------------|-------|
| 5. Brake | CHECK |
| 6. Master switch | ON |
| 7. Avionics power switch | OFF |
| 8. Electrical equipment | OFF |
| 9. Alternator | ON |
| 10. Wingtip position / Strobe lights | ON |

4.3 STARTING PROCEDURES

4.3.1 COLD ENGINES

The following starting procedures are recommended, however, the starting conditions may necessitate some variation from these procedures.

1. Perform pre-flight inspection.
2. Set propeller governor control in "High RPM" position.
3. Open throttle approximately 1/4 travel.
4. Turn boost pump "ON".
5. Move mixture control to "FULL RICH" until a slight but steady fuel flow is noted (approximately 3 to 5 seconds) and return mixture control to "IDLE CUT-OFF".
Turn boost pump "OFF".
6. Engage starter.
7. When engine fires release the ignition switch back to "BOTH".
8. Move mixture control slowly and smoothly to "FULL RICH".
9. Check the oil pressure gauge. If minimum oil pressure is not indicated within 30 seconds, shut off the engine and determine trouble.

4.3.2 HOT ENGINES

Because of the fact that the fuel percolates and the system must be cleared of vapor, it is recommended to use the same procedure as outlined for cold engine start.

4.4 TAXIING THE AIRCRAFT

- | | |
|--------------------------|--|
| 1. Canopy | CLOSE AND LOCK |
| 2. Brake | CHECK |
| 3. Altimeter | Set on QFE or QNH
Scale error max. +60 ft |
| 4. Avionic master switch | ON |
| 5. Electrical equipment | ON |
| 6. Radio | Set and test |
| 7. Mixture | Leave in "FULL RICH" position |

Operate only with the propeller in minimum blade angle (High RPM).
Warm-up at approximately 1000-1200 RPM. The engine is ready for take-off when the throttle can be opened without the engine faltering.

4.5 TAKE-OFF PROCEDURE

4.5.1 BEFORE TAKE-OFF

Before you line up at the runway for take-off:

- Check oil pressure and oil temperature.
- Check the magnetos on 1800 RPM. Allowed drop is 175 RPM (max. difference 50 RPM).
- Check Alternator Output
- Move also the propeller control through its complete range to check operation and return to full "High RPM" position. Turn boost pump "ON" (check indicator movement on the fuel flow gauche).

NOTE

The RPM Gauge is electronically operated. To check the magnetos the RPM source switch must be set to the same magento as the ignition switch. Otherwise the gauge will show zero.

4.5.2 TAKE-OFF

Set throttle smoothly to max and let the airspeed go up to 60-65 KIAS. A light pressure on the stick lifts the tail to horizontal position. Rotate the aircraft at 65 KIAS. On reaching climb speed of 100 KIAS reduce the RPM / Manifold Pressure to 2400/24" and proceed climbing.

4.6 CLIMB

Due to noise protection, the maximum continuous RPM is restricted to 2400.

If not stated somewhere else (refer to Section: 4.12 Acrobatic Maneuvers) the aircraft may be operated in the acrobatic maneuvers up to 2700 RPM. RPM above 2400 should, however, be used only for acrobatic maneuvers when necessary for maximum performance in order to avoid unnecessary noise.

Turn boost pump "OFF".

4.7 CRUISE

- | | |
|-----------------|---------------------------------------|
| 1. Altitude | - As selected |
| 2. Throttle/RPM | - Adjust for cruising speed |
| 3. Mixture | - Adjust for minimum fuel consumption |
| 4. Trim | - As required |
| 5. Fuel | - Check periodically |

4.8 LANDING PROCEDURES

4.8.1 DESCENT

- | | |
|-------------------|------------------------|
| 1. Throttle | - Reduce |
| 2. Mixture | - "FULL RICH" |
| 3. RPM Control | - Set to 2400 RPM |
| 4. Trim | - Adjust |
| 5. Fuel selector* | - "ACRO & CENTER TANK" |

NOTE *

Although safe operation did not require the use of the tanks in a specific sequence, it is recommended to set fuel selector to "ACRO & CENTER TANK" position!

4.8.2 APPROACH

- | | |
|--------------------|--------------------------------|
| 1. Boost pump | - ON |
| 2. Mixture | - set to "Rich" |
| 3. Airspeed | - reduce to approach speed |
| 4. Propeller pitch | - set to low angle (High RPM). |

NOTE

It is recommended to set the RPM to 2400 during approach and landing in order to avoid unnecessary noise.
In case of "Go Around", RPM control must be set to max. RPM before applying power.

4.8.3 BEFORE LANDING

- | | |
|----------------------|----------------------|
| 1. Landing approach | - proceed at 80 KIAS |
| 2. Airspeed on final | - maintain 70 KIAS |
| 3. Elevator trim | - adjust |

NOTE

Stall speed will be

- | | |
|-----------------|---------|
| MTOW = 820 kg : | 55 KIAS |
| MTOW = 920 kg : | 59 KIAS |

4.8.4 NORMAL LANDING

- | | |
|--------------|--|
| 1. Landing | - perform as practicable with respect to surface and weather condition |
| 2. Touchdown | - 3 point landing |

NOTE

The rudder is effective down to 30 KIAS

- | | |
|-------------|--------------------|
| 3. Throttle | - CLOSE / IDLE |
| 4. Braking | - Minimum required |

4.9 GO-AROUND

Decide early in the approach if it is necessary to go around and then start go-around before too low altitude and airspeed are reached.

Proceed as follows:

- | | |
|----------------|---|
| 1. RPM control | - "HIGH RPM" / Full forward |
| 2. Throttle | - "OPEN" / Take-off power |
| 3. Airspeed | - Minimum 90 KIAS
rotate to go-around altitude |

4.10 SHUTDOWN

- | | |
|--------------------------|------------------------------|
| 1. Boost pump | - "OFF" |
| 2. Engine | - Run for 1 min. at 1000 RPM |
| 3. Dead cut check | - Perform |
| 4. Avionic master switch | - "OFF" (if installed) |
| 5. Mixture | - "IDLE CUT OFF" |
| 6. Ignition switch | - "OFF" |
| 7. Master switch | - "OFF" |

4.11 LEAVING THE AIRCRAFT

- | | |
|----------------|------------------|
| 1. Canopy | - Close and lock |
| 2. Aircraft | - Secure |
| 3. Pitot cover | - Attach |
| 4. Log book | - Complete |

4.12 ACROBATIC MANEUVERS

4.12.1 GENERAL

NOTE

Prior to executing these maneuvers tighten harnesses and check all loose items are stowed. Start the maneuvers at safe altitude and max continuous power setting if not otherwise noted.

For maneuver limits refer to Section 2 LIMITATIONS.

After termination of acrobatic maneuvers the artificial horizon (if installed) must be reset if possible.

At high negative g-loads and zero g-periods it is normal that oil pressure and RPM indication might drop down momentarily returning to normal status at positive g-loads.

WARNING

The high permissible load factors of the airplane may exceed the individual physiological limits of pilot . This fact must be considered when pulling or pushing high g's.

4.12.2 MANEUVERS

CAUTION

Particular caution must be exercised when performing maneuvers at speeds above V_a (158 KIAS). Large or abrupt control inputs above this speed may impose unacceptably high loads which exceed the structural capability of the aircraft.

Acrobatics is traditionally understood as maneuvers like loop, humpty bump, hammerhead turn, aileron roll etc..

This manual does not undertake to teach acrobatics, however, it is meant to demonstrate the plane's capabilities.

For this reason maneuvers are divided into segments. The segments are described. Limitations are pointed out.

- Segment horizontal line:

A horizontal line may be flown with any speed between V_s and V_{ne}

- Segment line 45° climbing:
The plane will follow the line at max. power. The speed will not decrease below 80 KIAS.
- Segment line 90° up:
Any entry speed may be used. Out of a horizontal pull-up at 200 KIAS the vertical penetration will be 2.500 ft. The speed will gradually decrease to 0.

NOTE

In extremely long lines an RPM decay may occur. This is related to a loss of oil pressure. Positive g's should be pulled immediately in order to protect the engine. Oil pressure will return immediately.

- Segment line 45° diving:
Throttle must be reduced in order to avoid exceeding V_{ne} .
- Segment line 90° diving:
Throttle must be reduced to idle in order to avoid exceeding V_{ne} .

Above segments may be filled up with aileron rolls on snap rolls. Watch $V_A = 158$ KIAS for aileron rolls with max. deflection.

Snap rolls should not be performed at speeds above 140 KIAS.

- Segment 1/4 loop, climbing:
The minimum recommended speed is 100 KIAS. If the maneuver is to be followed by a vertical line, a higher entry speed is required depending on the expected length of the line. A complete loop can be performed at speeds above 100 KIAS.

NOTE

Since the maximum horizontal speed is 185 KIAS, higher speeds should be avoided in acrobatics since an unnecessary loss of altitude would occur.

- Torque maneuvers:
All maneuvers with high angular velocity associated with high propeller RPM must be considered dangerous for the engine crankshaft.

Although wooden composite propeller blades are used, the gyroscopic forces at the prop flange are extremely high.

CAUTION

If performing a gyroscopic maneuver such as flat spin, power on, or knife edge spin, reduce RPM to 2400 in order to minimize the gyroscopic forces.

4.12.3 SPIN

To enter a spin proceed as follows:

- Reduce speed, power idle
- When the plane stalls:
 - kick rudder to desired spin direction
 - hold ailerons neutral
 - stick back (positive spinning), Stick forward (negative spinning)

The plane will immediately enter a stable spin.

- Ailerons against spin direction will make the spin flatter.
- Ailerons into spin direction will lead to a spiral dive.

Above apply for positive and negative spinning.

To stop the spin:

- Apply opposite rudder
- Make sure, power idle
- Hold ailerons neutral
- Stick to neutral position

The plane will recover within 1/2 turn.

Recovery can still be improved by feeding in in-spin ailerons.

NOTE

If ever disorientation should occur during spins (normal or inverted) one method always works to stop the spin:

- Power idle
- Kick rudder to the heavier side
(this will always be against spin direction)
- Take hands off the stick

The spin will end after 1/2 turn. The plane will be in a steep dive in a side-slip.

Recovery to normal flight can be performed easily.

NOTE

After six turns of spinning the altitude loss including recovery is 2000 ft.

SECTION 5

PERFORMANCE

Table of Contents

<i>Paragraph</i>		<i>Page</i>
5.1	GENERAL	5-3
5.1.1	Performance Charts	5-3
5.1.2	Definitions of Terms	5-3
5.1.3	Sample Problem	5-3
5.2	ISA CONVERSION	5-5
5.3	AIRSPEED CALIBRATION	5-6
5.4	STALL SPEED	5-7
5.5	TAKE-OFF PERFORMANCE	5-8
5.6	RATE OF CLIMB PERFORMANCE	5-9
5.7	TIME TO CLIMB, FUEL TO CLIMB	5-10
5.8	RANGE AND ENDURANCE	5-11
5.9	FUEL CONSUMPTION	5-12
5.10	CRUISE PERFORMANCE	5-13
5.11	LANDING PERFORMANCE	5-14

Left blank intentionally

SECTION 5

PERFORMANCE

5.1 GENERAL

Performance data charts on the following pages are presented to facilitate the planning of flights in detail and with reasonable accuracy under various conditions. The data in the charts have been computed from actual flight tests with the aircraft and engine in good condition and using average piloting techniques.

It should be noted that the performance information presented in the range and endurance charts allow for 45 minutes reserve fuel at specified speeds. Some indeterminate variables such as engine and propeller, air turbulence and others may account for variations as high as 10% or more in range and endurance. Therefore, it is important to utilize all available information to estimate the fuel required for the particular flight.

5.1.1 Performance Charts

Performance data are presented in tabular or graphical form to illustrate the effect of different variables. Sufficiently detailed information are provided in the tables so that conservative values can be selected and used to determine the particular performance figure with reasonable accuracy.

All speeds in this chapter are Indicated Air Speeds (IAS). The performance figures below are given under following conditions.

1. Maximum allowed weight 920 kg (2028 lbs) except otherwise stated
2. Take-off and landing on concrete surface.
3. No wind.
4. Standard atmospheric condition.

5.1.2 Definitions of Terms

For definition of terms, abbreviations and symbols refer to section 1, General.

5.1.3 Sample Problem

TAKE-OFF CONDITIONS

Field Pressure Alt	2000 ft
Temperature	15°C
Wind Component (Headwind)	8 KT
Field Length	3000 ft

CRUISE CONDITIONS

Total Distance	400 NM
Pressure Altitude	8000 ft
Temperature (ISA)	-1°C

TAKE-OFF

Take-Off Distance is shown by Fig. 5.5

Example:

-T/O Weight:	870 kg (1918 lbs)
-Ground Roll:	112 m (367 ft)
-Total Distance to clear a 50 ft obstacle:	248 m (813 ft)

These distances are well within the available field length incl. the 8 Kt headwind.

RATE OF CLIMB

Fig. 5.6 shows the Rate Of Climb using Takeoff Power

The Rate of Climb at 2000 ft : 2320 ft/min

The Time to Climb from 2000 ft to 8000 ft is acc. to Fig. 5.7:

=> (4,0 - 0,9) min = 3,1 min

The Fuel to Climb from 2000 ft to 8000 ft is:

=> (5,8 - 1,4) Liters = 4,4 Liters (1.2 US Gal.)

CRUISE

Cruise Altitude and Power Setting should be determined for most economical fuel consumption and several other considerations. In an altitude of 8000 ft and a Power Setting of 65 % a Fuel Consumption of 52 L/H (13.7 US Gal/H) and 3,25 NM/L (12.3 NM/US Gal) can be obtained by Fig. 5.9.

RANGE AND ENDURANCE

Fig. 5.8 presents Range and Endurance values for a T/O Weight of 920 kg (2028 lbs) including fuel for warm up and Take-Off from SL, max continuous Power climb to cruising altitude, and a reserve of 21 liter (5.5 US Gal.) for 45 minutes with 45% Power. 2 liters (0.53 US Gal.) unusable fuel is taken into account.

For the sample problem (appr.)

Total Fuel	171 L	(45.17 US Gal.)
Warm Up & T/O-	5 L	(1.32 US Gal.)
Reserve	- 21 L	(5.55 US Gal.)
Unusable Fuel	- 2 L	(0.53 US Gal.)
	=====	=====
Usable Fuel	143 L	(37.8 US Gal.)
Range	415 NM	(768 km)
Endurance	2.49 HRS	

5.2 ISA CONVERSION

ISA Conversion of pressure altitude and outside air temperatur

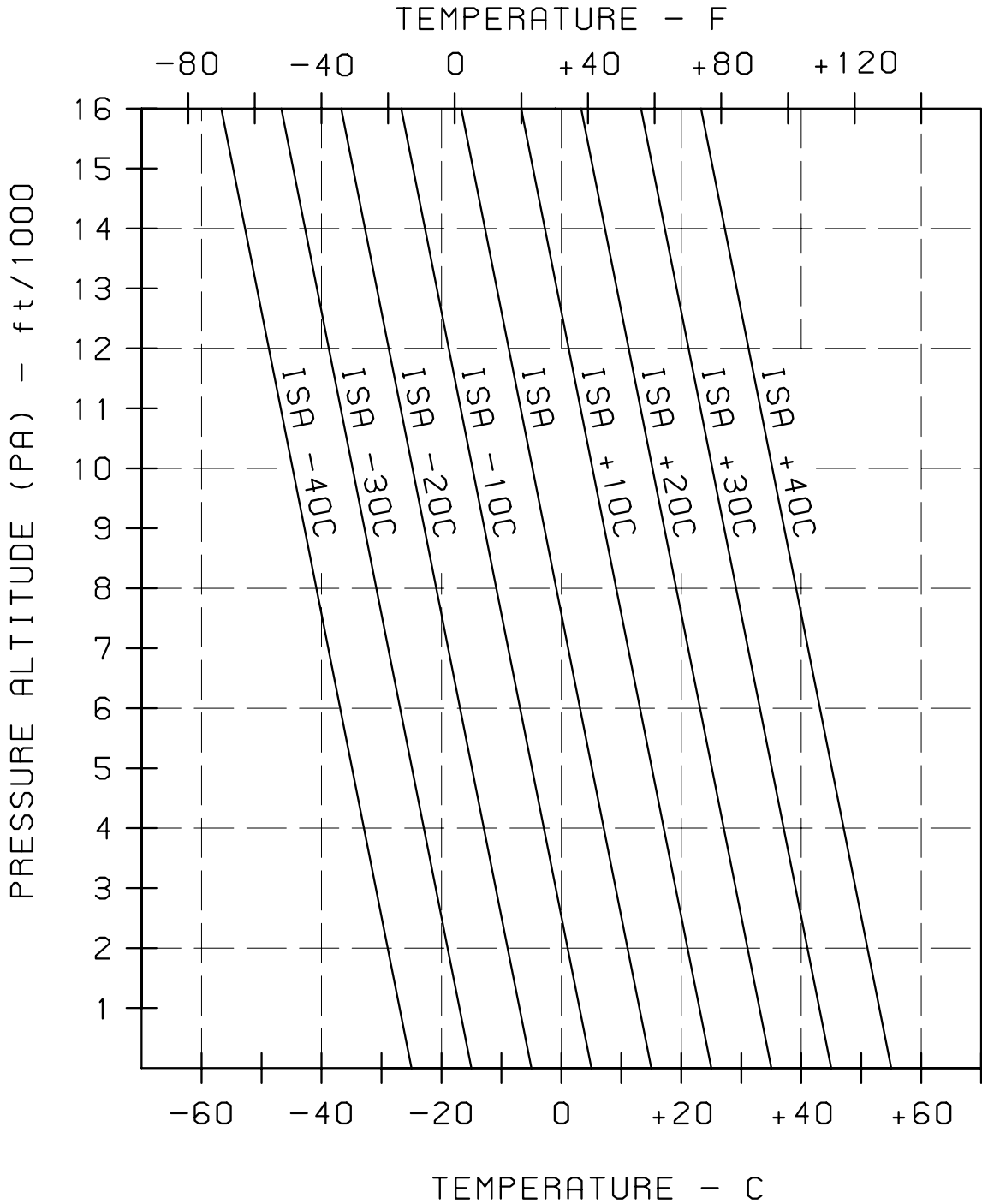

5.3 AIRSPEED CALIBRATION

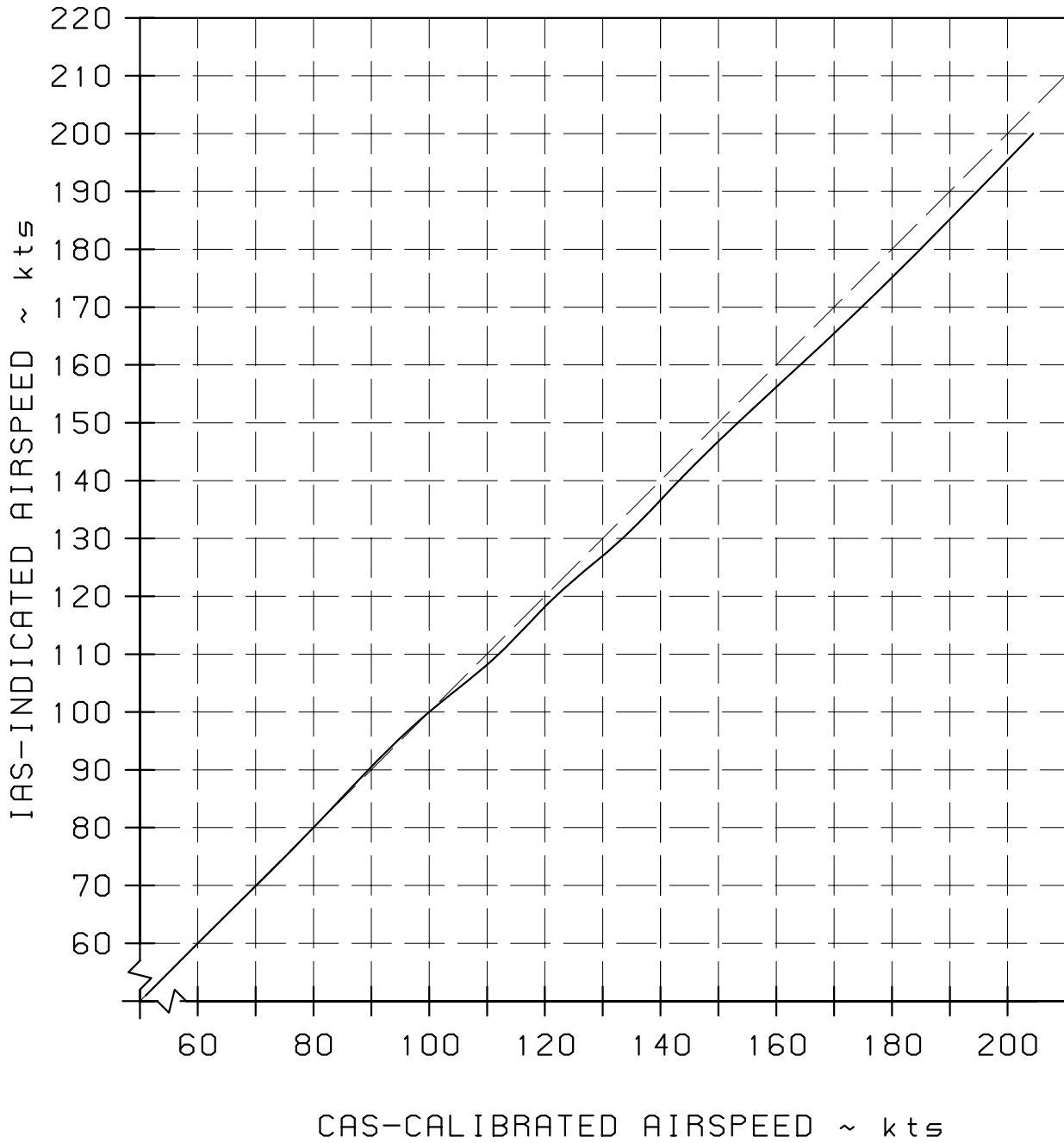

NOTE

Indicated airspeed assumes zero instrument error

5.4 STALL SPEED

CONDITION:

POWER IDLE
FORWARD C/G

STALL SPEEDS

ANGLE OF BANK

WEIGHT	CATEGORY	0°	30°	45°
		1g	1,15 g	1,41 g
920 kg (2028 lbs)	NORMAL	KIAS 59	KIAS 64	KIAS 70
820 kg (1808 lbs)	ACRO	KIAS 55	KIAS 59	KIAS 65

Max altitude loss during stall recovery is approximately 100 ft

5.5 TAKE-OFF PERFORMANCE

Power : T/O Power
Runway: Concrete

Note :

For every 5 kts headwind, the T/O distance can be decreased by 4%. For every 3 kts Tailwind (up to 10) kts, the T/O distance is increased by 10%. On a solid, dry and plain Grass Runway, the T/O is increased by 15%.

OAT			0°C (32°F)		15°C (59°F)		30°C (86°F)	
T/O weight	Rotating Speed	PA	T/O Roll	T/O over 50 ft	T/O Roll	T/O over 50 ft	T/O Roll	T/O over 50 ft
kg (lbs)	KIAS	ft	m (ft)	m (ft)	m (ft)	m (ft)	m (ft)	m (ft)
920 (2028)	65	SL	96 (315)	207 (679)	115 (377)	248 (813)	133 (436)	285 (935)
		2000	115 (377)	248 (814)	138 (453)	298 (978)	160 (525)	342 (1122)
		4000	138 (453)	298 (978)	166 (545)	357 (1171)	192 (630)	410 (1345)
		6000	166 (545)	358 (1175)	199 (653)	429 (1407)	230 (755)	492 (1614)
870 (1918)	62	SL	78 (256)	167 (548)	93 (305)	200 (656)	107 (351)	230 (755)
		2000	94 (308)	200 (656)	112 (367)	240 (787)	128 (420)	276 (906)
		4000	112 (367)	241 (791)	134 (440)	288 (945)	154 (505)	331 (1086)
		6000	135 (443)	289 (948)	161 (528)	346 (1135)	185 (607)	397 (1302)
820 (1808)	60	SL	67 (220)	114 (374)	79 (259)	170 (558)	93 (305)	200 (656)
		2000	80 (262)	173 (568)	95 (312)	204 (669)	112 (367)	240 (787)
		4000	97 (318)	207 (679)	114 (374)	248 (814)	134 (440)	288 (945)
		6000	116 (381)	249 (817)	137 (449)	294 (965)	161 (528)	347 (1138)

5.6 RATE OF CLIMB PERFORMANCE

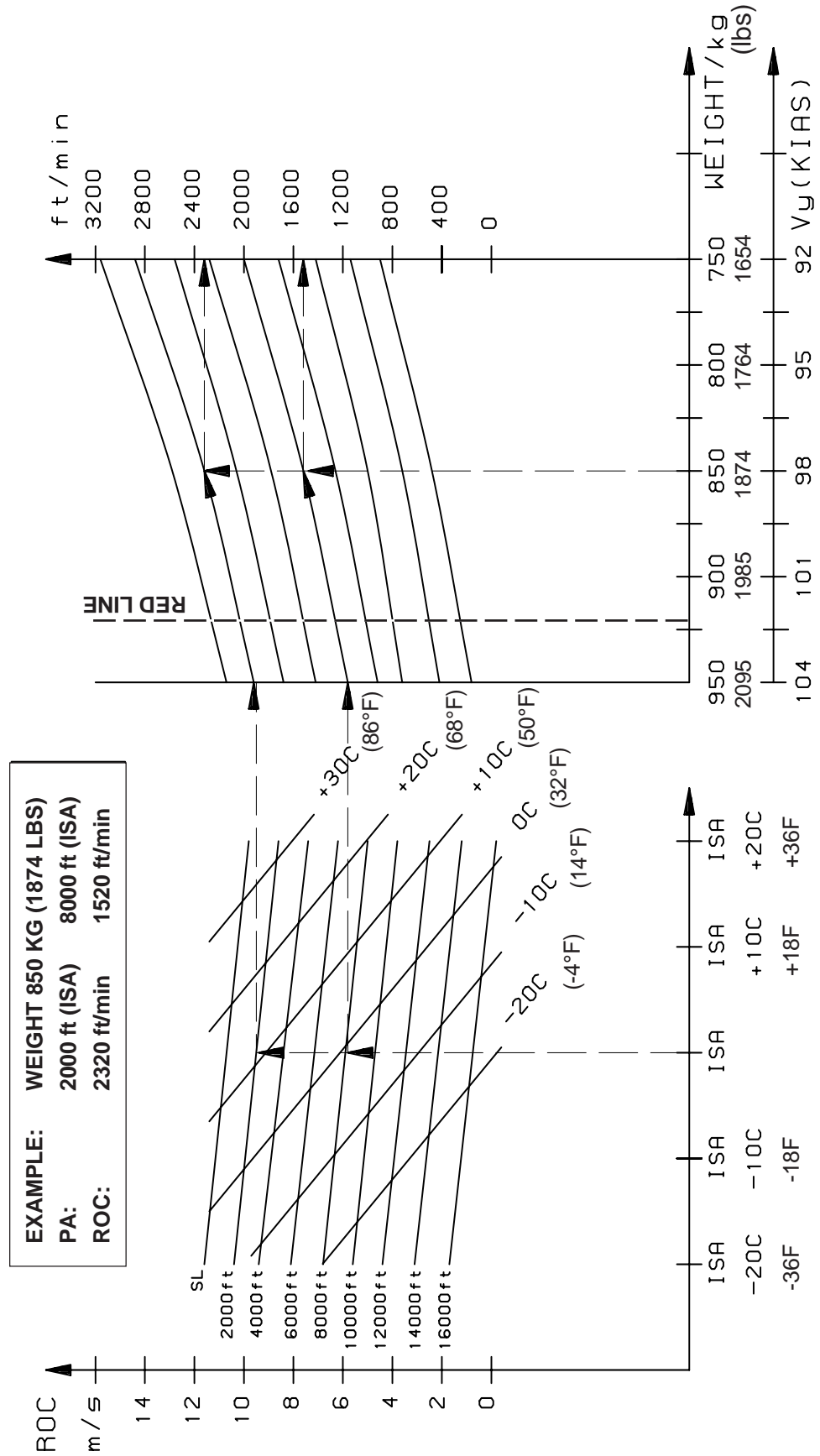

5.7 TIME TO CLIMB, FUEL TO CLIMB

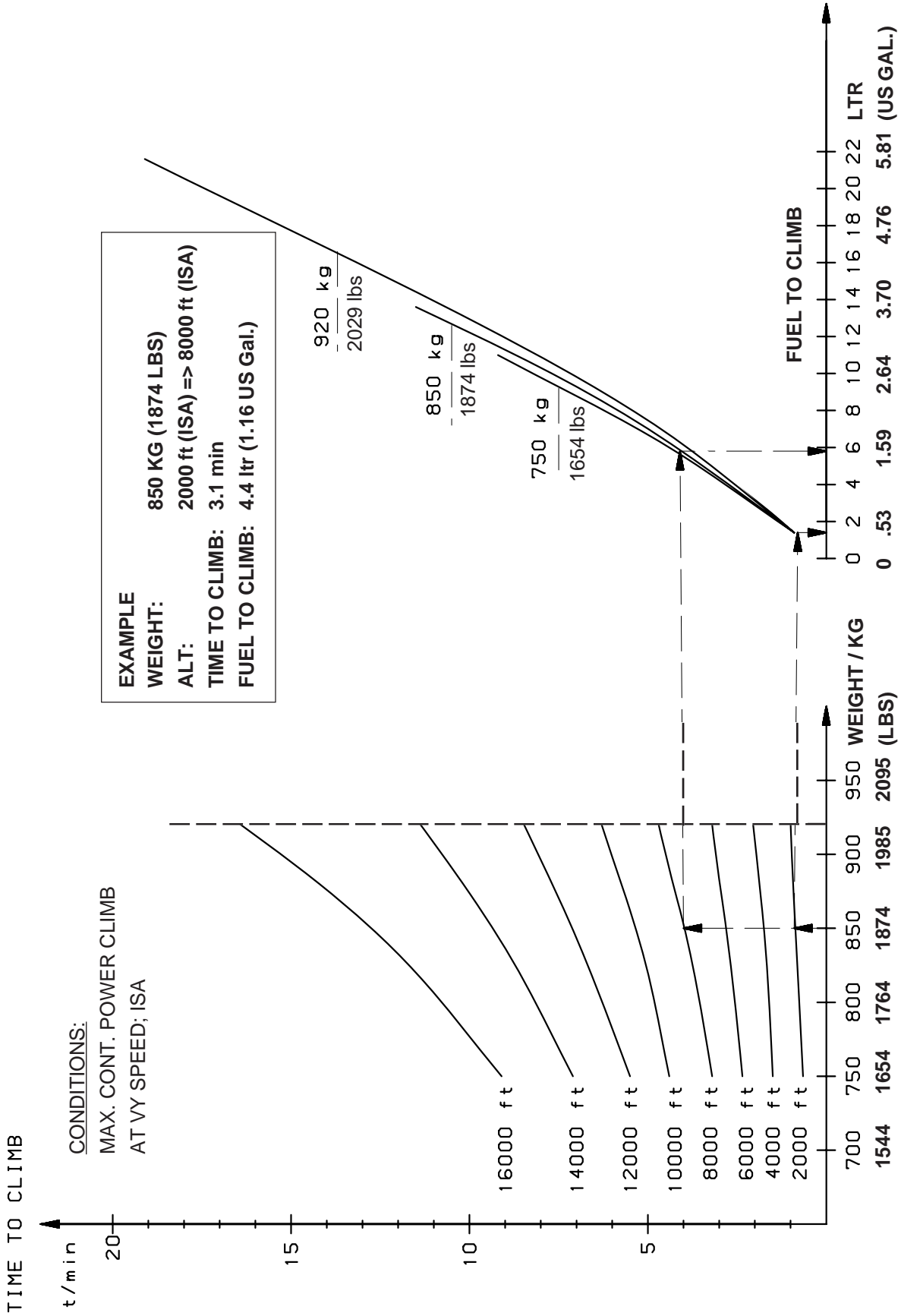

5.8 RANGE AND ENDURANCE

CONDITION:
 T/O WEIGHT: 920 KG (2028 LBS)
 TOTAL FUEL CAP.: 171 LTR (45.2 US GAL.)
 INCL. WARM UP & T/O: 5 LTR (1.3 US GAL.)
 RESERVE: 21 LTR (5.5 US GAL.)
 UNUSABLE FUEL: 2 LTR (0.5 US GAL.)

T/O FROM SL AND MAX CONT. POWER CLIMB
 TO CRUISING ALTITUDE
 (ISA CONDITIONS)

EXAMPLE:
 POWER SETTING: 65% RPM=2350 MP=21,5 "HG
 CRUISE ALT : 8000 ft
 RANGE : 415 NM
 ENDURANCE : 2,49 HRS

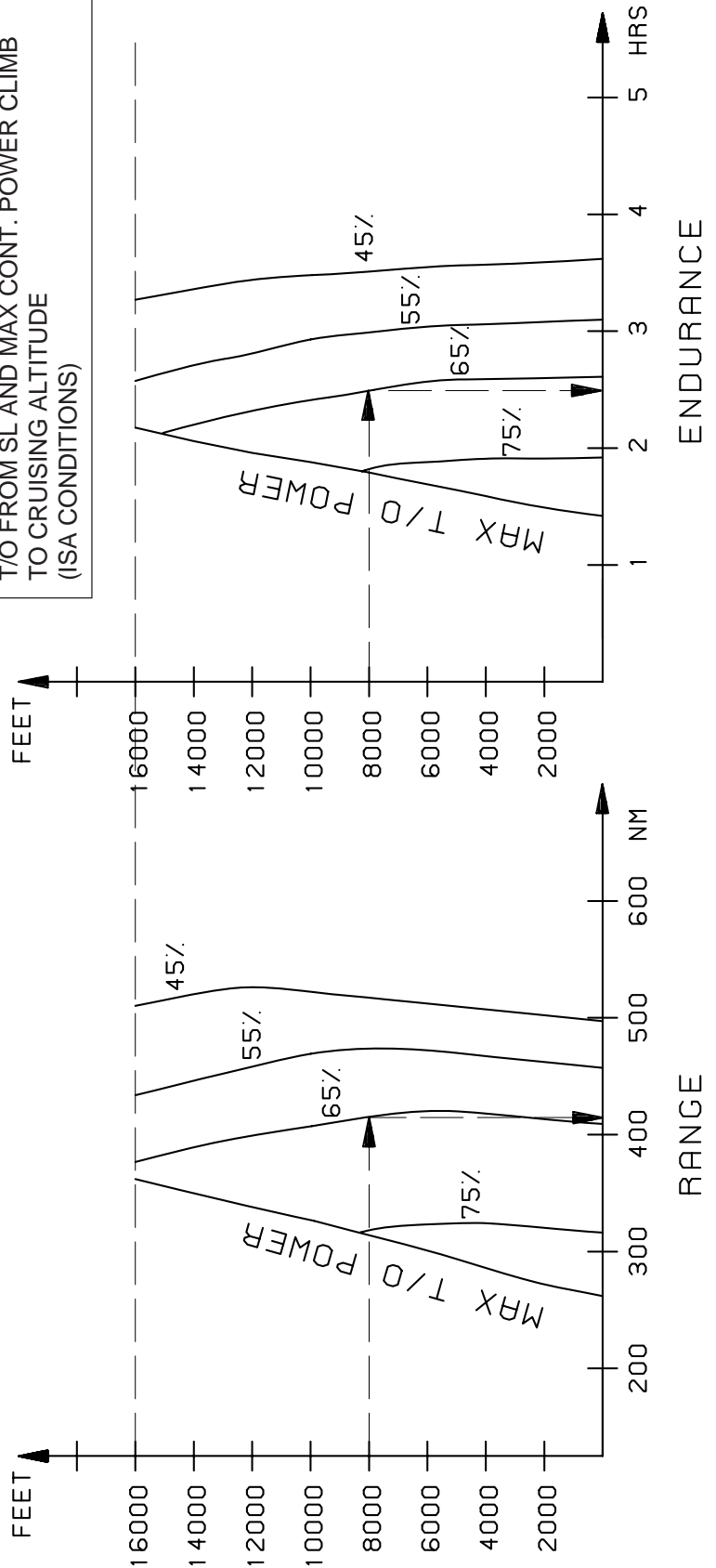

5.9 FUEL CONSUMPTION

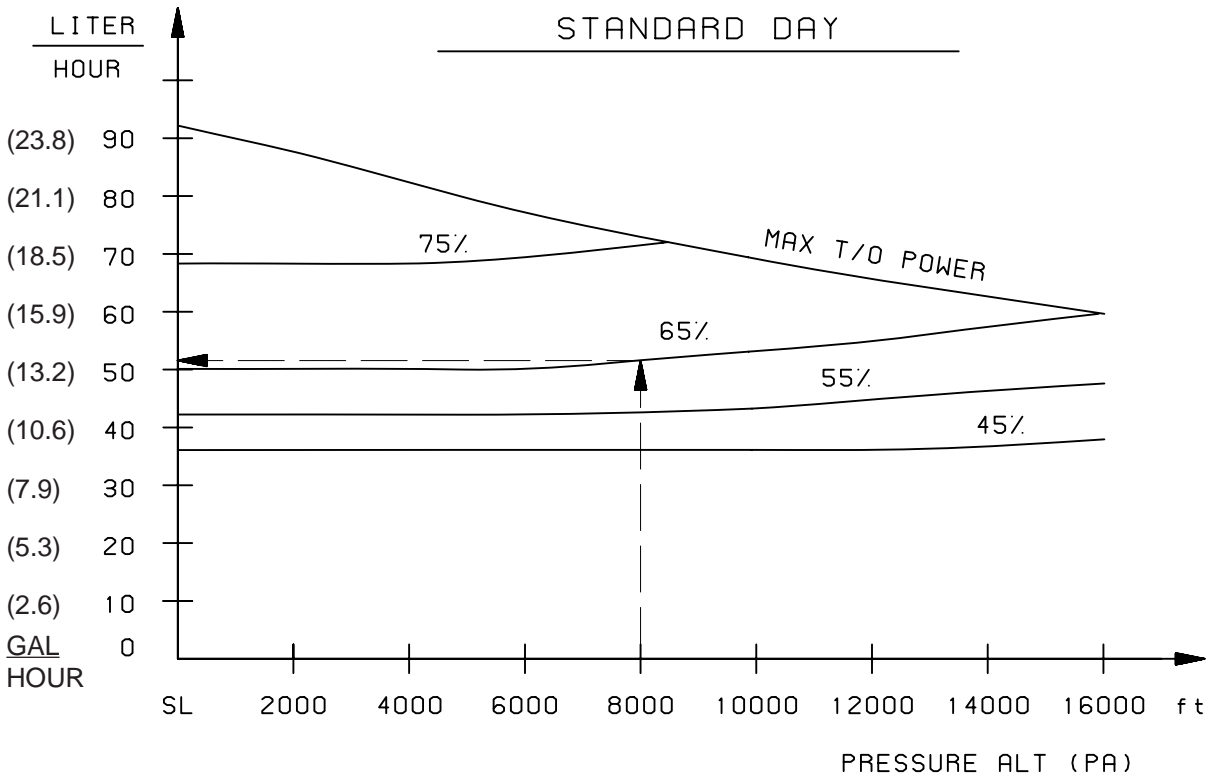

EXAMPLE:
 PA = 8000 ft (ISA); POWER SETTING 65%
 FUEL CONSUMPTION:
 => 52 LTR/HRS (13.7 GAL/HRS)
 => 3.25 NM/LTR (12.3 NM/GAL)

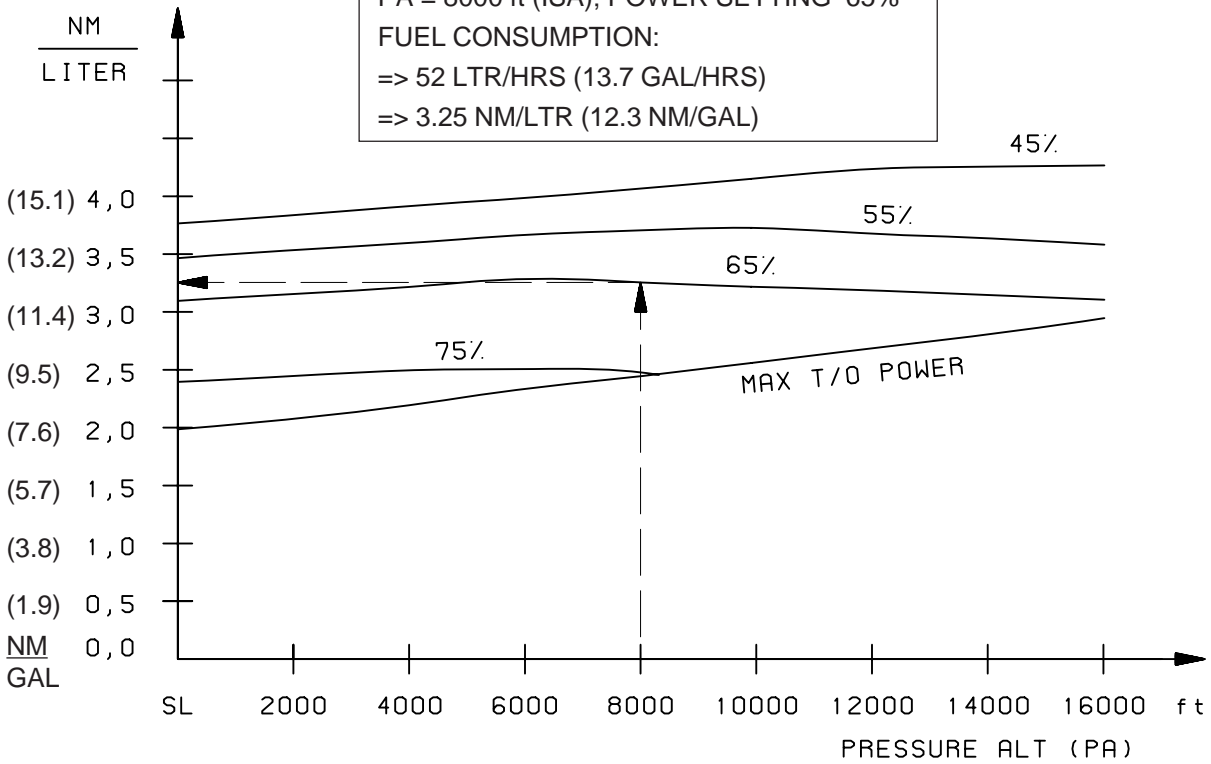

5.10 CRUISE PERFORMANCE

Range and Endurance values for a T/O Weight of 920 kg (2028 lbs) including fuel for warm-up and Take-Off from SL, max. cont. Power climb to cruising altitude, and a reserve of 21 liters (5.55 Gal) for 45 minutes with 45% Power. 2 liters (0.53 Gal) unusable fuel is taken into account. (At ISA - Conditions.)

PA [ft]	Eng. [RPM]	Manif. Press. [IN HG]	Power Setting		Fuel Consumption		TAS [Kts]	IAS [Kts]	Endur. ① [h]	Range ① [NM]	Mixture ② Best ...
			[%]	[Hp]	[l/h]	[gal/h]					
2000	2400	25,1	75	225	68,7	(18,2)	167,6	160	1.91	320	Power
	2200	24,2	65	195	50,5	(13,3)	159,3	152	2.60	413	Economy
	2000	23,5	55	165	42,6	(11,3)	150,2	144	3.08	462	Economy
	2000	20,2	45	135	36,5	(9,6)	139,9	134	3.59	502	Economy
4000	2400	24,6	75	225	68,7	(18,2)	170,9	158	1.91	324	Power
	2200	23,7	65	195	50,5	(13,3)	162,4	150	2.59	418	Economy
	2000	23,0	55	165	42,6	(11,3)	153,1	142	3.06	467	Economy
	2000	19,7	45	135	36,5	(9,6)	142,6	133	3.59	507	Economy
6000	2200	23,2	65	195	50,5	(13,3)	165,6	149	2.57	422	Economy
	2000	22,5	55	165	42,6	(11,3)	156,1	141	3.04	472	Economy
	2000	19,3	45	135	36,5	(9,6)	145,4	131	3.53	512	Economy
8000	2350	21,5	65	195	52,0	(13,7)	169,0	147	2.49	415	Economy
	2050	21,4	55	165	43,0	(11,4)	159,3	139	2.99	472	Economy
	2000	18,8	45	135	36,5	(9,6)	148,4	130	3.51	517	Economy
10000	2150	19,9	55	165	43,7	(11,5)	162,5	138	2.93	469	Economy
	2000	18,4	45	135	36,5	(9,6)	151,4	129	3.48	522	Economy
12000	2300	18,3	55	165	45,2	(11,9)	165,9	136	2.81	458	Economy
	2000	17,9	45	135	36,5	(9,6)	154,5	127	3.44	526	Economy
14000	2400	17,0	55	165	46,7	(12,3)	169,4	135	2.71	446	Economy
	2075	17,7	45	135	37,1	(9,8)	157,8	122	3.36	520	Economy

NOTE

- ① For temperatures above/ below Standard (ISA), increase/decrease Range 1,7% and Endurance 1,1% for each 10°C above/below Standard Day Temperature for particular altitude.
- ② "Best Power" or "Best Economy" see latest issue of Textron Lycoming Operator's Manual (4-10) Series AEIO 540.

5.11 LANDING PERFORMANCE

Power : Idle
Runway: Concrete
Brakes: maximum

NOTE

For every knot headwind, the landing distance can be decreased by 3%.
On a solid, dry and plain Grass Runway, the landing is increased by 15%.

OAT			0°C (32°F)		15°C (59°F)		30°C (86°F)	
Landing weight	Airspeed	PA	Land. Roll	Land. over 50 ft	Land. Roll	Land. over 50 ft	Land. Roll	Land. over 50 ft
[kg] / (lbs)	[KIAS]	[ft]	[m] / (ft)	[m] / (ft)	[m] / (ft)	[m] / (ft)	[m] / (ft)	[m] / (ft)
920 (2028)	80	SL	171 (561)	527 (1729)	177 (581)	548 (1798)	185 (607)	586 (1923)
		2000	181 (594)	558 (1831)	188 (617)	580 (1903)	197 (646)	602 (1975)
		4000	192 (630)	592 (1942)	199 (653)	615 (2018)	208 (682)	639 (2096)
		6000	203 (666)	627 (2057)	211 (692)	652 (2139)	220 (722)	678 (2224)
870 (1918)	78	SL	158 (518)	488 (1601)	164 (538)	507 (1663)	171 (561)	527 (1729)
		2000	165 (541)	518 (1699)	175 (574)	537 (1762)	181 (594)	558 (1831)
		4000	177 (581)	548 (1798)	185 (607)	570 (1870)	192 (630)	592 (1942)
		6000	188 (617)	582 (1909)	195 (640)	605 (1985)	203 (666)	627 (2057)
820 (1809)	75	SL	150 (492)	465 (1526)	156 (512)	483 (1585)	163 (535)	502 (1647)
		2000	159 (522)	492 (1614)	166 (545)	511 (1677)	173 (568)	532 (1745)
		4000	168 (551)	522 (1713)	176 (577)	543 (1781)	184 (604)	565 (1854)
		6000	179 (587)	553 (1814)	186 (610)	575 (1886)	194 (636)	598 (1962)

SECTION 6

WEIGHT AND BALANCE AND EQUIPMENT LIST

Table of Contents

<i>Paragraph</i>		<i>Page</i>
6.1	GENERAL	6-3
6.2	AIRCRAFT WEIGHING PROCEDURE	6-3
6.2.1	Owners Weight and Balance Record	6-4
6.3	CENTER OF GRAVITY CALCULATION (SAMPLE PROBLEM)	6-5
6.3.1	Sample	6-7
6.3.2	Weight and Balance Record Sheet	6-7
6.4	LOADING WEIGHTS AND MOMENTS	6-8
6.5	WEIGHTS AND MOMENT LIMITS	6-9
6.6	EQUIPMENT LIST	6-10

Left blank intentionally

6.1 GENERAL

This section describes the procedure for establishing the basic weight and moment of the aircraft. Sample forms are provided for reference. Procedures for calculating the weight and movement for various operations are also provided. A comprehensive list of all equipment available for this aircraft is included. It is the responsibility of the pilot to ensure that the aircraft is loaded properly.

6.2 AIRCRAFT WEIGHING PROCEDURE

The aircraft weight is determined by weighing all three wheel loads simultaneously by three scales with the aircraft levelled. (Upper fuselage reference line horizontal)

Datum line for weight arms x is the fire wall.

X_1 = distance: fire wall - main wheel

X_2 = distance: fire wall - tail wheel

X_N = distance: fire wall - item N

X_G = distance: fire wall - Center of Gravity

W_1 = Sum of weights indicated by the two scales below the main wheels

W_2 = Weight indicated by the scale below the tail wheel

W = Total weight = $W_1 + W_2$

$X_G = \frac{(W_1 \times X_1) + (W_2 \times X_2)}{W}$ = C/G position

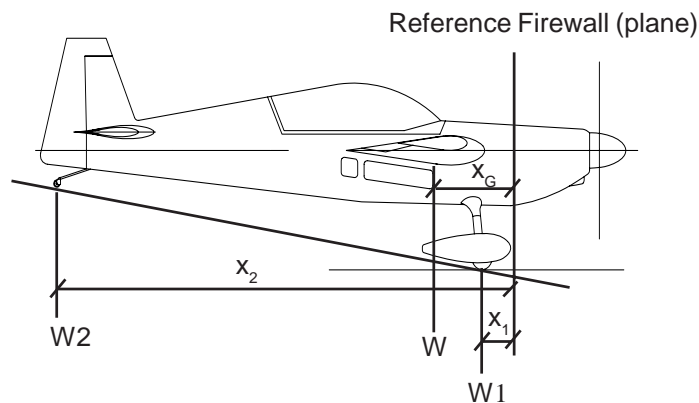

$$W = W_1 + W_2, \quad X_G = \frac{(W_1 \times X_1) + (W_2 \times X_2)}{W}$$

6.3 CENTER OF GRAVITY CALCULATION (SAMPLE PROBLEM)

Position	PILOT		FUEL IN ACRO TANK 9 LTR (2,37 US GAL)		FUEL IN CENTER TANK 42 LTR (11,1 US GAL)		FUEL IN WING TANK 120 LTR (31,7 US GAL)	
	(kg)	(lbs)	(kg)	(lbs)	(kg)	(lbs)	(kg)	(lbs)
①	60	132,3	-	-	-	-	-	-
②	60	132,3	6,5	14,3	-	-	-	-
③	60	132,3	6,5	14,3	30,2	66,6	-	-
④	60	132,3	6,5	14,3	30,2	66,6	86,4	190,5
⑤	90	198,5	-	-	-	-	-	-
⑥	90	198,5	6,5	14,3	-	-	-	-
⑦	90	198,5	6,5	14,3	30,2	66,6	-	-
⑧	90	198,5	6,5	14,3	30,2	66,6	86,4	190,5

6.3 CENTER OF GRAVITY CALCULATION (SAMPLE PROBLEM)

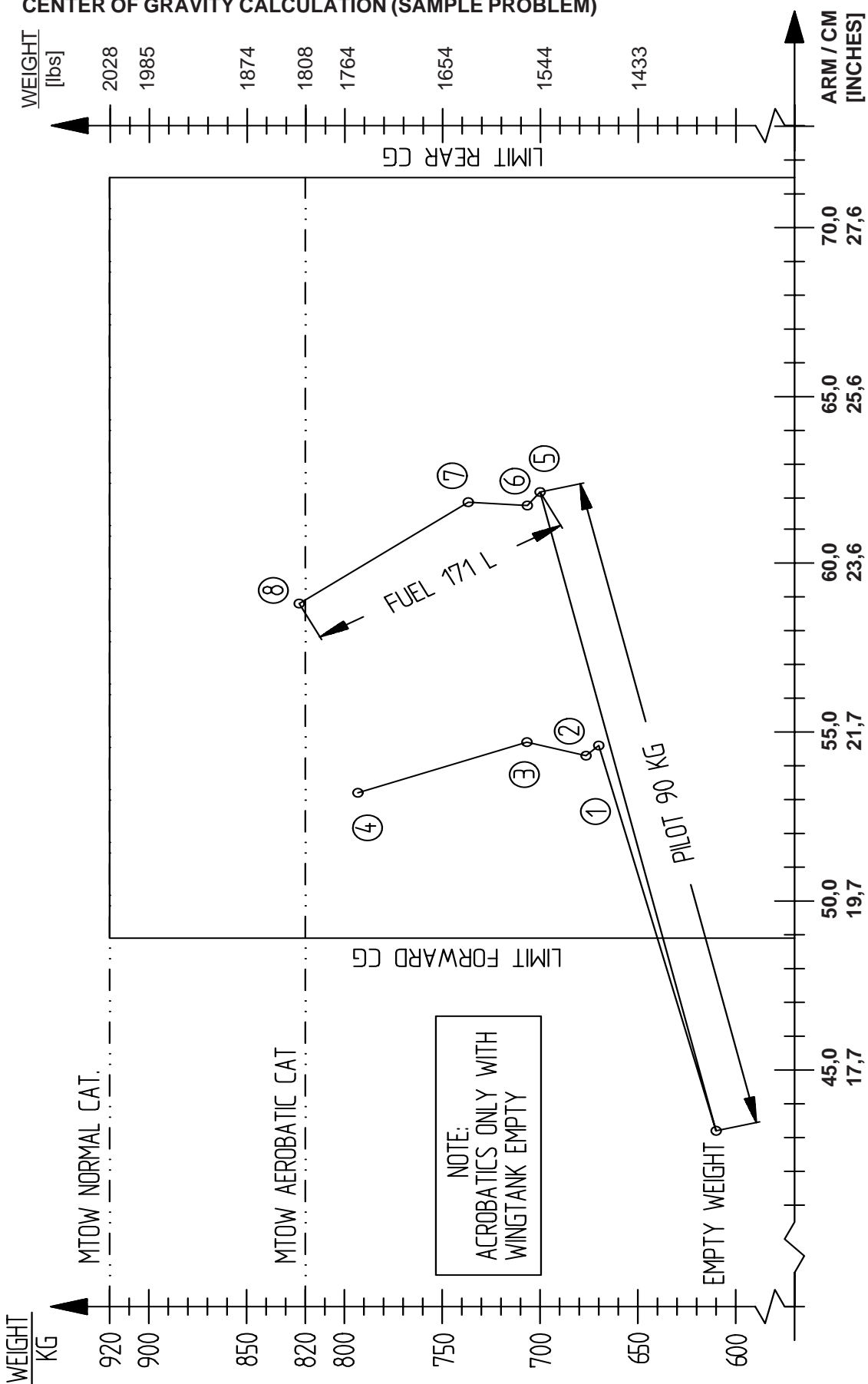

6.3.1 Sample

Take-off Condition		
Pilot	90,0 kg	(198,5 lbs)
Fuel in Acro Tank (9 L)	6,5 kg	(14,3 lbs)
Fuel in Center Tank (42 L)	30,2 kg	(66,6 lbs)
Fuel In Wing Tank (120 L)	86,4 kg	(190,5 lbs)
Aircraft Empty Weight	610,0 kg	(1345,1 lbs)
	=====	=====
	823,1 kg	(1815,0 lbs)

To find C/G, follow line "Pilot 90 KG" from Empty Weight to Point 5.
Now follow line "Fuel 171 L" via point 6 and 7 to point 8.

FIND: Weight ~ 823 kg (1815 lbs)
C/G ~ 58,8 cm (23,1 inch)

6.3.2 Weight and Balance Record Sheet

	WEIGHT	ARM	MOMENT
EMPTY WEIGHT			
PILOT			
FUEL ACRO TANK			
FUEL CENTER TANK			
FUEL WING TANK			

$\Sigma W =$

$\Sigma (W \times X) =$

$$XG = \frac{\Sigma (W \times X)}{\Sigma W} =$$

6.4 LOADING WEIGHTS AND MOMENTS

WEIGHT Pilot + Parachute		PILOT <u>REAR SEAT POSITION</u> ARM = 190 cm (75 inch)		PILOT <u>FRONT SEAT POSITION</u> ARM = 170 cm (67 inch)	
KG	LBS	MOMENT KG x CM (INCH x LBS)			
60	132	11400	(9896)	10200	(8855)
65	143	12350	(10721)	11050	(9593)
70	154	13300	(11546)	11900	(10331)
75	165	14250	(12370)	12750	(11068)
80	176	15200	(13195)	13600	(11806)
85	187	16150	(14020)	14450	(12544)
90	198	17100	(14845)	15300	(13282)

FUEL IN SYSTEM: MAX 171 LITER (45,1 US GAL.)

<u>ACRO & CENTER TANK</u>			FUEL	<u>WING TANKS</u>		
LITER (US GAL)	KG (LBS)	KG x CM (IN LBS)	LITER (US GAL)	KG (LBS)	KG x CM (IN x LBS)	
9 (2,4)	6,5 (14,3)	168 (146)	10 (2,6)	7,2 (15,9)	238 (207)	
20 (5,3)	14,4 (31,8)	531 (461)	20 (5,3)	14,4 (31,8)	475 (412)	
25 (6,6)	18,0 (39,7)	696 (604)	40 (10,6)	28,8 (63,5)	950 (825)	
30 (7,9)	21,6 (47,6)	861 (747)	60 (15,9)	43,2 (95,3)	1426 (1238)	
35 (9,2)	25,2 (55,6)	1026 (891)	80 (21,1)	57,6 (127,0)	1901 (1650)	
40 (10,6)	28,8 (63,5)	1191 (1034)	100 (26,4)	72,0 (158,8)	2376 (2063)	
45 (11,9)	32,4 (71,4)	1356 (1177)	120 (31,7)	86,4 (190,5)	2851 (2475)	
51 (13,5)	36,7 (80,9)	1554 (1349)				

6.5 WEIGHTS AND MOMENT LIMITS

**EXAMPLE: AT 750 KG (1654 LBS) AND 44000 KGCM (38197 IN LBS)
CG LOCATION IS 58,7 CM (23,1 IN) AFT OF REF DATUM**

WEIGHT
kg [lbs]

950 (2028)

900 (1985)

850 (1874)

820 (1808)

800 (1764)

MTOW
ACRO

750 (1654)

MTOW NORMAL CAT.

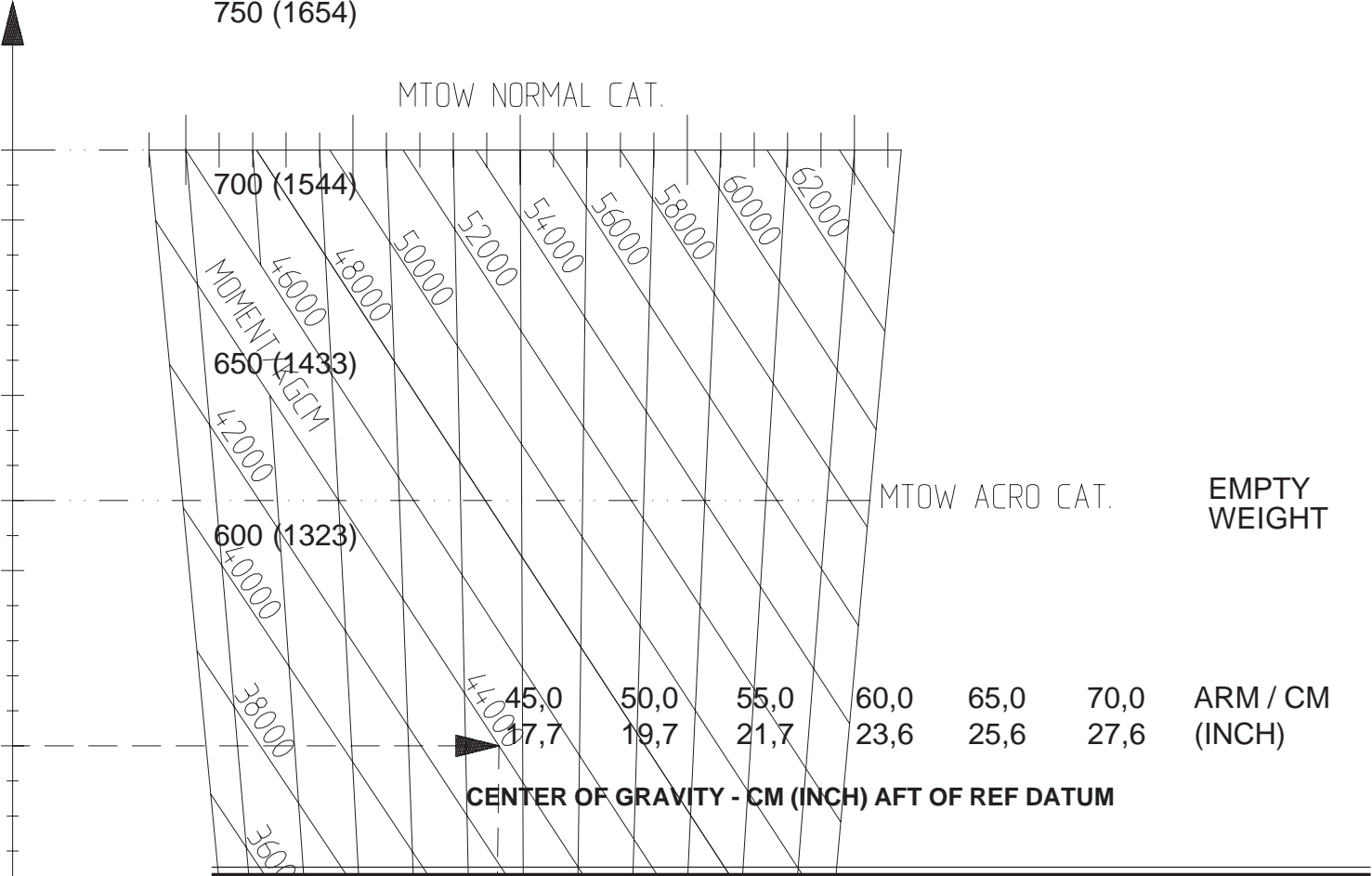

MTOW ACRO CAT.

EMPTY
WEIGHT

45,0 50,0 55,0 60,0 65,0 70,0 ARM / CM
17,7 19,7 21,7 23,6 25,6 27,6 (INCH)

CENTER OF GRAVITY - CM (INCH) AFT OF REF DATUM

6.6 EQUIPMENT LIST

EXTRA 300S S/N:

QTY	ITEM	MANUFACT.	PART OR P/N	WEIGHT (KG)	ARM (m)	MARK IF INSTALLED	REQUIRED (R) OPTIONAL (O) ALTERNAT. (A)
1	Engine	Textron Lycoming	AEIO-540-L1B5	194.90	-0.72		R
1	Magneto L/H	Slick	6251 or 6351	2.30	-0.15		R
1	Magneto R/H	Slick	6250 or 6350	2.00	-0.15		R
1	Engine	Textron Lycoming	AEIO-540-L1B5D	194.90	-0.72		A
1	Magnetos	Bendix	D6LN-3000	5.20	-0.15		A
4	Shock Mounts	Lord	J 7764-20	1.70	-0.29		R
4	Shock Mounts	Barry Controls	94016-02	1.70	-0.29		A
1	Exhaust System 6 in 2	EXTRA/ Sky Dynamics	63104A0	7.65	-0.40		R
2	Exhaust Silencer	Gomolzig	EA300 NSD GO3-606500	9.60	0.80		O
1	Exhaust System 6 in 1 with Silencer	Gomolzig	EA300-606000	8.20	-0.39		A
1	Fuel Injector	Bendix	RSA-10 AD 1	3.90	-0.68		R
1	El. Fuel Pump	Weldon Tool	8120-M or B8120-M	1.10	-0.04		R
1	Oil Cooler	Stewart Warner	8406 R	1.40	-0.90		R
1	2. Oil Cooler	Stewart Warner	8406 R	1.40	-0.20		R
1	Single Oilcooler, rear	Niagara NDM	20009A	1.81	-0.22		A
1	Single Oilcooler, rear	Aero Classics	8000353	1.65	-0.22		A
1	Set Fuel, Oil & Sens. Hoses in Eng. Comp.	div.	MS28741 with firesleeve	6.30	-0.21		R
1	Set Fuel, Oil & Sens. Hoses in Eng. Comp.	Parker/Stratoflex or Aeroquip	PTFE Type 124J or AE466	4.90	-0.21		A
1	Set Fuel, Oil & Sens. Hoses in Eng. Comp. single Oil Cooler Sys.	Parker/Stratoflex or Aeroquip	PTFE Type 124J or AE466	3.70	-0.15		A
1	Set Fuel Hoses in Cabin Comp.	div.	MS28741	2.10	0.40		R
1	Set Fuel Hoses in Cabin Comp.	Parker/Stratoflex or Aeroquip	PTFE Type 124 or 666	1.40	0.40		A
1	Sens. Hoses (Oil, Fuel & MA Press)	Knapp/Hoerbiger	HS3MA OR H3MM	0.15	0.82		A
1	RPM Vernier Control	ACS Products Co.	A-750-30-1080	0.65	0.60		R
1	Mixture Vernier Control	ACS Products Co.	A-750-20-1080	0.65	0.63		R
1	Throttle Control	Teleflex Marine	F303 03000	0.53	0.40		R
1	Propeller	MT-Propeller	MTV-9-B-C/C200-15	30.40	-1.15		R
1	Spinner	MT-Propeller	P-208-B				R
1	Spinner	MT-Propeller	P-810-2				A
1	Propeller	MT-Propeller	MTV-14-B-C/C190-17	29.80	-1.15		O
1	Spinner	MT-Propeller	P-238-A				O
1	Spinner	MT-Propeller	P-967				A
1	Cowling (GRP) incl. Air Intake Screen	EXTRA EXTRA	23205.01 & .02 83802.1	9.80	-0.52		R
1	Cowling (CRP) incl. Air Intake Screen	EXTRA EXTRA	23205.301 & .302 83802.1	8.80	-0.52		A
1	Cowling incl. Air Intake Screen	EXTRA	83001.0	9.20	-0.53		A

QTY	ITEM	MANUFACT.	PART OR P/N	WEIGHT (KG)	ARM (m)	MARK IF INSTALLED	REQUIRED (R) OPTIONAL (O) ALTERNAT. (A)
1	Governor	Woodward	A- 210 988	1.10	-0.91		R
1	Governor	MT-Propeller	P-880-5	1.10	-0.91		A
7	Switches	Cutler Hammer	div.	0.28	1.31		R
7	Switches	Kissling	div.	0.28	1.31		A
11	Circuit Breaker	Potter&Brumfield	div.	0.50	1.29		R
11	Circuit Breaker	ETA or Klixon	div.	0.30	1.29		A
1	Main Bus Fuseholder	MTA	03.00360	0.03	0.02		O
1	Main Bus Strip Fuse (40 Amps)	MTA	02.00300				O
1	PCB Auto Fuse	EXTRA	83290.1	0.01	0.02		O
1	Fuel Cont. Probe Wing Tank	VDO	226 801 015 001 G	0.12	0.33		R
1	Fuel Cont. Probe Center Tank	VDO	224 082 007 004R	0.19	0.68		R
1	Fuel Cont. Ind. Wing Tank	VDO	301 271 036 001 K or 301 030 001 G	0.08	1.30		R
1	Fuel Cont. Ind. Acro Tank	VDO	301 272 052 001 K or 301 030 002 G	0.14	1.30		R
1	Ammeter	VDO	190 004 039 002 or 190 037 002 G	0.08	1.31		R
1	Volt/Ammeter	Electronics Intern.	VA-1A	0.26	1.30		A
1	Shunt	Electronics Intern.	S-50	0.09	1.20		A
1	Volt/Ammeter	Electronics Intern.	VA-1A-50	0.22	1.30		A
1	RPM Indicator	VDO	333 230 115 002 or 333 035 001 G	0.31	1.28		R
1	RPM Indicator digital	Horizon	P100-230-643-00	0.68	1.28		A
1	Magn. Dir. Ind.	Airpath	C 2300	0.25	1.30		R
1	Oil Press./ Oil Temp. Ind.	AMITEK or Christen	61943	0.51	1.30		R
1	Oil Press./ Oil Temp. Ind. (3 1/8")	Westach	3DA3-3MM or 3DA3-3KV	0.14	1.30		A
1	Oil Temp. Sender	Westach	W399-S9	0.08	-0.11		A
1	Oil Press Sensor	Mediamate	387-100MM or 387-100KV	0.12	0.04		A
1	Oil Press / Oil Temp Ind. (2 1/4")	Westach	2DA3-3MM or 2DA3-3KV	0.09	1.30		A
1	Oil Temp. Sender	Westach	W399-S9	0.08	-0.11		A
1	Oil Press Sensor	Mediamate	387-100MM or 387-100KV	0.12	0.04		A
1	Stall Sensor	EXTRA	73106.1	0.07	0.27		R
1	Stall Warning Horn	EMAG	EM-S 110P	0.13	1.20		R
1	G-Meter	EXTRA	DSA 12	0.37	1.28		O
1	G-Meter	Kollsman or Pioneer or Bendix	AN5745	0.40	1.28		O
1	G-Meter	EZE Technologies	DA-55	0.16	1.28		O
1	ELT and Antenna	Pointer	3000-10	0.90	0.72		O
1	Turn & Bank Ind.	United Instruments	9501-2 / TSO C3b	0.55	1.28		O
1	Turn & Bank Ind.	Castleberry	C101 / TSO C101T	0.55	1.28		O
1	Altimeter	United Instruments	UI5934PD-3 A.134	0.60	1.30		R

QTY	ITEM	MANUFACT.	PART OR P/N	WEIGHT (KG)	ARM (m)	MARK IF INSTALLED	REQUIRED (R) OPTIONAL (O) ALTERNAT. (A)
1	Altimeter, metric	Winter	4110	0.33	1.30		A
1	Altitude Encoder	ACK	A-30	0.15	0.95		O
1	Airspeed Ind.	Winter	6533-321	0.21	1.29		R
1	Airsp. Ind., metric	Winter	6531-321	0.21	1.29		A
1	Airspeed Ind.	United Instruments	UI8030 B.835	0.22	1.29		A
1	EGT/CHT	Westach	2 DA 1	0.07	1.30		O
1	EGT Probe	Westach	712-2 DWK	0.06	-0.37		O
1	CHT Probe	Westach	712-7 DK	0.05	-0.20		O
1	Manifold Press. Fuel Flow Ind.	United Instruments	UI6331-H.186	0.49	1.28		R
1	VHF Radio	Becker	AR 3201	0.90	1.26		R
1	VHF Radio	Becker	AR 4201	0.67	1.26		A
1	GPS / NAV / COM	Garmin	GNS 430	2.95	1.21		O
1	Transponder	Bendix/King	KT 73	1.64	1.21		O
1	Transponder	Bendix/King	KT 76A	0.89	1.21		O
1	Transponder	Filser	TRT-600 (LAST)	0.70	1.26		O
1	Transponder	Filser	TRT-800	0.70	1.26		O
1	Transponder	Garmin	GTX 327	0.95	1.21		O
1	Transponder	Garmin	GTX 330	1.50	1.21		O
1	Transponder	Becker	BXP6401-1	0.80	1.26		O
1	Transponder	Becker	BXP6401-2	0.80	1.26		O
1	Transponder	Becker	ATC-2000	1.20	1.21		O
1	Transponder	Becker	ATC-4401	0.73	1.26		O
1	Transponder Antenna	Comant Industries	CI 105	0.11	0.12		O
1	Transponder Antenna	Bendix/King	KA 60	0.11	0.12		O
1	COM Antenna	Moba	210FA	0.10	4.07		R
1	COM Antenna	Extra	83205A	0.10	4.07		A
1	COM Antenna	Pointer	P1 3001-10	0.05	4.07		A
1	Starter	B&C Speciality	BC 315-100-2	4.63	-0.85		R
1	Starter	SKYTEC (Lycoming)	149-12LS (31A22 104)	3.65	-0.85		A
1	Alternator 60 Amps with bracket	Electrosystems	ALX 8421 LS	5.90	-0.86		R
1	Voltage Regul.	Lamar	B-00371-25	0.15	0.02		R
1	Low Volt. Monitor	Lamar	B-00378-4				R
1	Alternator 65 Amps	Bosch	0 120 489 935	4.60	-0.86		A
1	Alternator 55 Amps	Bosch	0 120 489 917	4.20	-0.86		A
1	Alternator 55 Amps	Bosch	0 120 489 469	4.20	-0.86		A
1	Battery	Sonnenschein	Dryfit A 212/28G	10.70	0.17		R
1	Battery	Concorde	RG-25XC	10.40	0.17		A
1	Batt. Charger Plug	EXTRA	146 19 20	0.02	0.12		O
1	External Power Recept.	Div.	AN2552-3A	1.46	0.76		O
1	Ext. Power Solenoid	Switches Kidde	22735	0.40	0.02		O
1	Ext. Power Solenoid (cont. operation)	White-Rodgers	70-111-225-5	0.40	0.02		O

QTY	ITEM	MANUFACT.	PART OR P/N	WEIGHT (KG)	ARM (m)	MARK IF INSTALLED	REQUIRED (R) OPTIONAL (O) ALTERNAT. (A)
1	Main Bus Solenoid	White-Rodgers	70-111-226-5	0.40	0.02		R
1	Starter Solenoid	Switches Kidde	22735	0.40	0.02		R
1	Low Voltage Light	OAK	MS25041-2	0.02	1.31		R
1	Ignition Switch	TCM	10-357200-1	0.15	1.30		R
2	Wheel	Cleveland	40-151	4.00	0.16		R
2	Main Wheel Tires	Div	5.00-5 / 6PR	3.90	0.16		R
1	Tail Wheel 5"	EXTRA	steerable	5.50	4.91		A
1	Tail Wheel 5"	EXTRA	free swivel type	5.50	4.91		R
1	Tail Wheel 6" Assy (Soft)	Special Products Aviation Inc.		5.90	4.91		A
2	Brake Assy	Cleveland	30-164	1.40	0.16		R
2	Brake Cyl.	Cleveland	10-20 or 10-20E	0.55	0.89		R
2	Brake Cyl.	Matco	MC-4E	0.55	0.89		A
1	Brake Fluid Reservoir	EXTRA	53301.1	0.20	0.03		R
1	Brake Fluid Reservoir	ACS	A-315	0.20	0.04		A
1	Safety Belt Assy	Hooker	1 011 230 with ratchet	3.30	1.95		R
2	NAV/STROBE LTS	Whelen	A 600-PG/PR-14	0.23	0.56		R
2	Power Supply	Whelen	A490T	0.54	0.56		R
2	Electric Actuator Pedal Adjust.	SKF	CARR 22x200x1/D12B	3.25	0.65		R
1	Long Range Tank	EXTRA	84901	1.80	0.38		O
1	Fuel Selector	Spruce	108HD-04	0.30	0.56		R
1	Fuel Selector	Allen	6 S 122	0.19	0.56		A
1	Safety Cover (Polycarbonate)	EXTRA	84803.1	2.53	2.80		O
1	Dual Pump Smoke System without Pumps	EXTRA	84100	6.40	0.20		O
2	Smoke Oil Pump (Inject. and Refill)	ITT Jabsco	8860-1203	3.60	0.20		O
2	Smoke Oil Pump (Inject. and Refill)	ITT Jabsco	23620-3003	4.40	0.20		O
1	Smoke Oil Pump (Injection)	Johnson	F3B-19 (12V)	2.00	-0.05		O
1	Smoke Oil Pump (Refill)	Johnson	F2P10-19 (12V)	1.65	0.35		O
1	Single Pump Smoke System incl. Pump	EXTRA Marco	84112 UP3/OIL 12V	6.80	0.19		O
1	Airtow Hook	EXTRA/TOST	83607A0	0.50	5.10		O
1/2	Sighting Dev. LH/RH	EXTRA	84801.10	each 0.44	1.25		O
1	Aresti-Card Holder	EXTRA	Assy	0.09	1.32		O
2	Wing Tie Down Rings	EXTRA	83801.2-01	0.04	0.95		O

Left blank intentionally

SECTION 7

DESCRIPTION AND OPERATION
OF AIRCRAFT AND SYSTEMS

Table of Contents

<i>Paragraph</i>		<i>Page</i>
7.1	THE AIRCRAFT	7-3
7.2	FUSELAGE	7-3
7.3	WINGS	7-4
7.4	EMPENNAGE	7-4
7.5	FLIGHT CONTROL SYSTEM	7-5
7.5.1	Primary Control System	7-5
7.5.2	Longitudinal Flight Control System	7-5
7.5.3	Lateral Flight Control System	7-5
7.5.4	Directional Flight Control System	7-5
7.5.5	Secondary Control	7-5
7.6	INSTRUMENTATION	7-5
7.6.1	Instrument Panel	7-6
7.7	LANDING GEAR	7-7
7.8	SEATS, SEAT BELTS	7-7
7.9	CANOPY	7-8
7.10	POWER PLANT	7-8
7.10.1	Engine	7-8
7.10.2	Oil System	7-9
7.10.3	Engine Installation	7-9
7.10.4	Propeller	7-9
7.10.5	Throttle	7-9
7.10.6	Mixture	7-9
7.10.7	RPM-Control	7-9
7.10.8	Fuel Selector Valve	7-10
7.10.9	Exhaust Systems (Optional)	7-10
7.11	FUEL SYSTEM	7-10
7.12	ELECTRICAL SYSTEM	7-11
7.13	CABIN ENVIRONMENT CONTROL	7-13

Left blank intentionally

SECTION 7

DESCRIPTION AND OPERATION OF AIRCRAFT AND SYSTEMS

7.1 THE AIRCRAFT

The aircraft EXTRA 300/S is designed and developed by EXTRA Flugzeugproduktions- und Vertriebs- GmbH, Dinslaken 46569 Hünxe, Federal Republic of Germany, in accordance with the U.S. Federal Aviation Regulations, part 23, categories normal and acrobatic to fulfill the primary flight training, normal operation rules and acrobatic training up to the unlimited acrobatic level.

EXTRA 300/S is a light weight, robust, single piston-engined, one-seat aircraft with a fuselage structure in tig-welded steel-tube construction.

The landing gear, wing, and tail are made of epoxy, reinforced with glass- and carbonfiber. The items are qualified up to 72°C.

The standard aircraft is designed to operate within a range of ambient air temperature from -20°C to +44°C (-4°F => 111°F) at sea level. It is possible to start the engine using the aircraft battery at -20°C (-4°F) without preheating. Below -10° C (+14°F) OAT a special oil breather line must be adapted (available as kit).

7.2 FUSELAGE

The fuselage structure consists of a steel tube construction integrating the wing and empennage connections as well as the seat. The lower front part of the fuselage and the sides below the wing are faired with aluminium sheet metal. Within the exhaust area stainless steel sheet metal is used. To improve pilots view for acrobatic maneuvers a Lexan® window is installed in the lower fuselage skin. The rear part of the fuselage is covered with Ceconite® 102.

The upper fuselage body surface is one part from firewall to vertical stabilizer including the correlated canopy frame. It consists of a kevlar laminate.

The canopy frame itself is constructed by carbon laminate. The canopy is one part, opens to the right and is held in the open position by a belt. Emergency jettisoning is achieved by simply unlatching the canopy. For additional pilots protection a roll bar is installed behind the pilots seat.

7.3 WINGS

The wing is of CRP construction. The dual chamber main spar - being a fail safe design - consists of carbon roving caps combined with CRP webs. Core foam is a PVC foam (Divinycell HT 50). The wing shell is built by a Honeycomb sandwich with CRP laminates. To improve surface quality and for protection of the carbon wing shell an outer layer of glass fibre, except of the tank area, is applied. In the area of the wing tanks is a layer of CRP laminate with an incorporated aluminium thread bonded to the metal fuselage structure as means of lightning protection. To prevent buckling of the shell plywood ribs are installed. These ribs are permanently protected from environmental effects by an epoxy coating. The connection to the fuselage is arranged by two bolts piercing through the spar parallel to the centerline of the fuselage and two brackets at the rear spars. Integral fuel cells are provided in the leading edge of the wing extending from the root ribs to half the span of each R/L and L/H wing. The ailerons are supported at three points in spherical bearings pressed into aluminium brackets. To reduce pilot's hand forces the hinge line of the ailerons is positioned 25% of the aileron depth at the root and 21,5% at the tip. Furthermore the ailerons are equipped with "spades" to decrease pilot forces. Ailerons are controlled via the center bracket. To prevent flutter the ailerons are weight balanced in the overhanging leading edge.

7.4 EMPENNAGE

The EXTRA 300/S possesses a cruziform empennage with stabilizers and moveable control surfaces. The rudder is balanced aerodynamically at the tip. Spars consist of PVC foam cores, CRP caps and GRP laminates. The shell is built by honeycomb sandwich with GRP laminates. Buckling is prevented by plywood ribs. Deviating from the other control surfaces the elevator, due to aerolastic reasons, entirely is built by CRP. On the R/H elevator half a trim tab is fitted with two hinges. The control surfaces are mounted in spherical bearings (exception: Trim tab). To prevent flutter rudder and elevator are mass balanced. The balance weight for the rudder is installed in the rudder tip while the balance weight for the elevator is mounted on the elongated center bracket of the elevator extending into the fuselage.

7.5 FLIGHT CONTROL SYSTEM

7.5.1 PRIMARY CONTROL SYSTEM

The EXTRA 300/S is standard equipped with conventional stick-type control columns and electric adjustable rudder pedals. The primary control surfaces are operated through a direct mechanical linkage.

7.5.2 LONGITUDINAL FLIGHT CONTROL SYSTEM

The stick bearing is housed in a torque tube, which is also linked to the lateral flight controls. The stick movements are transferred to the elevator by a push-pull rods.

7.5.3 LATERAL FLIGHT CONTROL SYSTEM

Push-pull rods are connected by sealed ball bearings from the torque tube to the ailerons. The ailerons are statically as well as dynamically balanced. (Dynamically with spades). The ailerons are supported by lubricated, sealed bearings.

7.5.4 DIRECTIONAL FLIGHT CONTROL SYSTEM

The rudder pedals with brake pedals are adjustable and operate the rudder through a cable system. Springs keep the cables under tension when the pedals are not operated.

The pedal adjustment is achieved with electric linear actuators. The pedal adjustment system provides an in-flight capability to adjust the pedals according to the pilot size and operation e. i. for long cross country flight a more relaxed, stretched seating position is possible. A full travel from the most rearward to the most forward position takes approximately 15sec.

7.5.5 SECONDARY CONTROL

The elevator trim control is located on the right side in the cockpit. The actuation is a fail safe design to prevent flutter in case of a single control joint failure.
The canopy lock is operated from the outside by a handle on left side of the canopy by reaching into the cockpit through the window. The handle is used for locking as well as for normal operation and for emergency release.
The starter/magneto switch is located on the left side of the instrument panel.

7.6 INSTRUMENTATION

Standard equipment incorporates a magneto compass, an airspeed indicator, altimeter, fuel gauges, engine-RPM and manifold pressure / fuel flow indicator as well as an ampermeter and a low voltage warning. Further dual instruments exhaust gas / cylinderhead temperature indicator and oil temperature / pressure indicator are installed.
Instruments and placards can be provided with markings in either metric or English units. The colour markings in instruments follow US-FAR, part 23 recommendation (see section 2).

7.6.1 INSTRUMENT PANEL

For instrument panel arrangement of the cockpit refer to Fig. 7.6.1, which includes standard and optional equipment marked as such.

Fig. 7.6.1

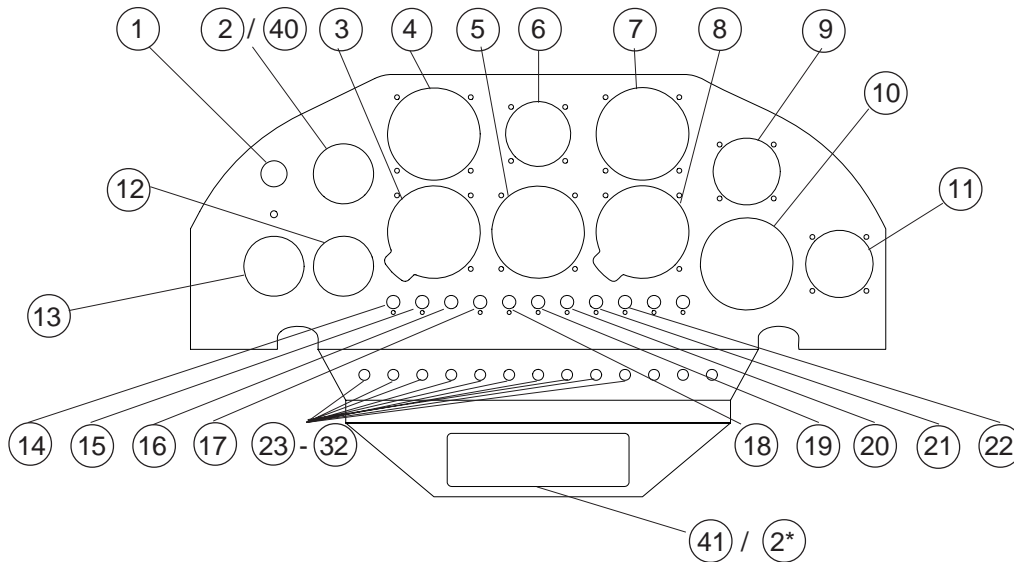

Standard	Optional	Position	Item
x		1	Magneto Selector Switch & Starter
x		2	Amperemeter
x		3	Altimeter
x		4	Air Speed Indicator
x		5	Manifold Pressure / Fuel Flow
x		6	Magn. Direction Indicator
x		7	Oil Pressure / Oil Temperature
x		8	G-Meter
x		9	EGT / CHT
x		10	RPM Indicator
x		11	COM
x		12	Fuel Quantity Center Tank
x		13	Fuel Quantity Wing Tank
x		14	Master Switch
x		15	Field Switch
x		16	Low Voltage Monitor
x		17	Boost Pump Switch
x		18	Nav Light Switch
x		19	Strobe Light Switch
x		20	Radio Master Switch
x		21	Left Pedal Adjustment Switch
x		22	Right Pedal Adjustment Switch
x		23	Circuit Breaker Stall Warning
x		24	Circuit Breaker Alt Field
x		25	Circuit Breaker Alt Output
x		26	Circuit Breaker Starter

Standard	Optional	Position	Item
x		27	Circuit Breaker Boost Pump
x		28	Circuit Breaker Nav Lights
x		29	Circuit Breaker Strobes
x		30	Circuit Breaker Radio
x		31	Circuit Breaker Fuel & RPM Gauges
x		32	Circuit Breaker Pedal Adjustment
x		33	RPM control, Prop governor
x		34	Mixture control
x		35	Throttle lever
x		36	Stick
x		37	Radio button
x		38	Fuel shutoff valve
x		39	Trim lever and indicator
	x	40	Turn & bank indicator
	x	41	GPS

NOTE

This list may be modified by the minimum equipment requirements of individual certifying authorities!

7.7 LANDING GEAR

The landing gear is a composite construction with a multichamber fiberglass spring in a tail-wheel design. The main wheels have a size of 5-5.50 and they are equipped with hydraulic disc brakes. The tail wheel has a solid rubber tire with full-swivel capability.

7.8 SEATS, SEAT BELTS

The seat is an ergonomical shaped carbon composite construction. It's back rest position and angle is mechanically adjustable on ground by quickpins and bolts. The lower seat surface itself is fixed.

Seat to pedal distance can be varied on ground and in flight using the electrically actuated pedal adjustment system. Each pedal can be adjust separate by a switch on the instrument panel.

The seat belt assembly consists of right and left shoulder straps, two right and two left lap belts and a negative g-strap. All belts are adjustable. The lap belts have a separate single point release for redundant safety during acrobatic maneuvers. If one release is opened unintentionally the second one guarantees full safety. To assure safe operation one release must be closed to the right the other one to the left. During acrobatic maneuvers the seat belt system should be tightened firmly.

7.9 CANOPY

The canopy is manufactured in one section. The canopy can be manually operated and opened by lifting to the right.

Interior canopy locking handles, located on the left side on the canopy must be pulled together to unlock the canopy from the inside. To open the canopy from the outside there are no separate handles, this means it must be opened by reaching through the small window (bad weather window) and proceed as mentioned above (interior opening).

7.10 POWER PLANT

7.10.1 ENGINE

The power plant consists of one Textron-Lycoming six-cylinder, horizontally opposed, aircooled, direct drive, fuel injection engine type with inverted oil system. The T/O Power is 300 HP at 2700 RPM.

Engine specification: a) Textron - Lycoming AEIO-540-L1B5
b) Textron - Lycoming AEIO-540-L1B5D

For the present TBO refer to latest issue of Textron-Lycoming SERVICE LETTER No. L 201.

The AEIO-540-L1B5 (D) engine is equipped with special antivibration counterweights.

The following accessories are included in the power plant installation:

-Fuel Injector:	Bendix
-Magnetos:	Slick
-Alternator:	Electrosystem
-Starter:	B&C
-Fuel pump:	Gates Lear
-Shielded ignition system	
-Propeller governor drive	
-Transistor voltage regulator	

The engine is operated with the following manual controls:

- Throttle control
- RPM control
- Fuel mixture control

The propeller governor monitors the RPM automatically and prevents overspeeding. In the event that oil pressure is lost the propeller is automatically adjusted to coarse pitch in order to avoid overspeeding.

The use of 100/130 aviation grade fuel (AVGAS 100/100LL) is the minimum grade recommended by the manufacturer of the engine.

For continuous operation 115/145 aviation fuel is the maximum grade.

7.10.2 OIL SYSTEM

The oil is cooled by a Two Cooler System mounted on the left hand side in the engine compartment.

Alternatively a Single Cooler System is available. In this case the oil is cooled by one oil cooler mounted on the aft, right hand side of the engine. The oil level is determined by a dip-stick.

Oil capacity:

Max sump capacity:	16 qts.
Min sump capacity:	-Acro 12 qts.
	-Normal 9 qts.

For temperatures and oil grades refer to Section 1.7.

7.10.3 ENGINE INSTALLATION

The engine is mounted with four shock-mounts (Type LORD or BARRY CONTROLS) to the tig-welded steel tube engine support, which is attached to the fuselage with four bolts on the firewall axis.

The engine cowling is divided into two parts, a lower and an upper part both made of glass-fibre reinforced epoxy. The parts are fixed by a number of screws and the upper cowling has a separate hatch for easy access to the oil dip-stick.

7.10.4 PROPELLER

The propeller is a 4-blade wood composite, constant speed propeller type MTV-14-B-C/ C190-17 with a diameter of 1,9 m, or optional with a 3-blade propeller type MTV-9-B-C/ C200-15 with a diameter 2,0 m .

7.10.5 THROTTLE

Control lever (cub-type) mounted on the left side in cockpit.

7.10.6 MIXTURE

Vernier control located at right side of cockpit (red knob).

7.10.7 RPM-CONTROL

Vernier control located at left side of cockpit (blue knob) Push-pull type with friction lock on the left side of the rear cockpit.

Preselection of RPM possible due to constant speed governor.

7.10.8 FUEL SELECTOR VALVE

A rotary fuel selector valve is mounted behind the firewall on the right side of the fuselage. A torque tube connects the valve to the cockpit handle. Pull and turn the handle 90° to open the valve to the Acro & Center tank. A further 90° turn switches to the Wing tank fuel supply.

Position down = CLOSED
Position left = ACRO & CENTER TANK
Position up = WING TANK

7.10.9 EXHAUST SYSTEMS (OPTIONAL)

Optionally the EA 300/S can be equipped with an additional silencer system type Gomolzig. The attachment is integrated in the fuselage structure. Thus no modifications are necessary to install the silencer system.
Alternatively a complete 6 in 1 System with integrated silencer is available.

7.11 FUEL SYSTEM

The fuel system consists of two separate, independent tanks:
- Acro & Center tank in the fuselage
- Wing tank (LH and RH)

Wing tank:

The root section of each wing - in front of main spars forms an integral fuel tank providing two interconnected tanks with 120 liters (31,7 US GAL.) total capacity. Each side of the wing has a 2" diameter filler cap for gravity refueling. The wing tank can be completely emptied in flight but the normal amount of unusable fuel is approximately 2 Liters (0.5 US Gallon).

Acro & center tank:

An Acro tank 9 liters (2,3 US Gal.) is mounted in the fuselage just behind the firewall and the Center tank 42 liters (11,1US Gal.) just behind the main spar of the wing. The Acro tank is connected with the center tank in a gravity feed system. The center tank has a 2" diameter filler cap for gravity refueling. Unusable fuel is approximately 2 liters (0,5 US Gal.)

Adequate venting is provided in each tank to a main ventilation-tube, ending outside the fuselage at the right side.

In addition to the engine driven fuelpump an electrically driven auxiliary fuel pump (boost pump) with by-pass and having sufficient capacity to feed the engine at take-off power is fitted as a safety device against failure of the engine-driven pump. The boost pump switch is located on the instrument panel.

A fuel filter with drain is installed between the fuel selector valve and the boost pump. Separate drains are located at the lowest point of each tank system.

Normal float type transducers and electrically operated fuel indicators are used.

7.12 ELECTRICAL SYSTEM

The electrical power generation system consists of a 12 V alternator with rectifier and transistor voltage regulator. The alternator is mounted on and driven by the engine.

The field current is controlled by the voltage regulator to give a nominal output of 13,8 V under all load conditions.

Circuit protection against over-voltage is provided by the voltage regulator.

The maximum load taken from the alternator is 40 amp.

The system is equipped with a low voltage monitor that gives a visual warning if the aircraft voltage drops below 12,75 V.

The master-switch is located on the instrument panel.

A 12 V leak proof battery is connected across the alternator output to stabilize the supply and to maintain all essential services in the event of an alternator failure and when the engine is not operating. The battery is mounted behind the firewall.

All electrical circuits are protected by circuit breakers located on the instrument panel and they are easily accessible to the pilot during flight.

The electrical system is adequately suppressed to ensure satisfactory operation of the radio equipment.

All wires, switches, circuit breakers etc. are manufactured to related aeronautical specifications.

Standard Equipment shown only

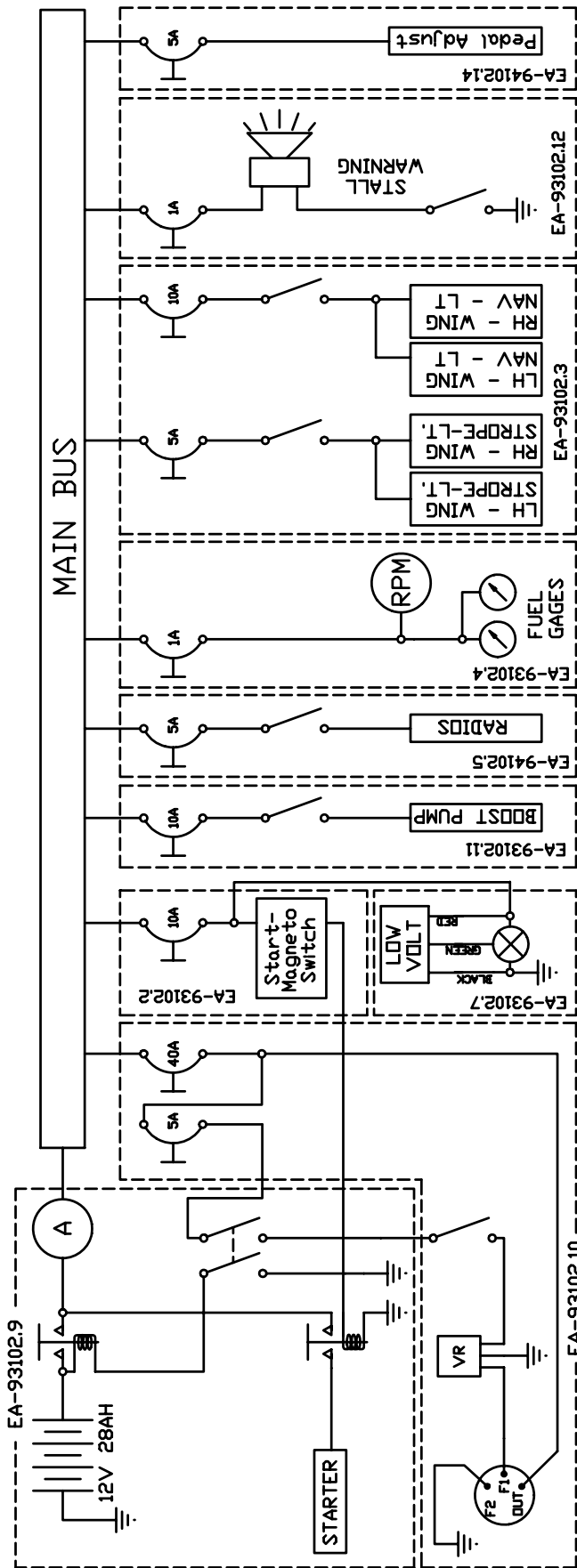

7.13 CABIN ENVIRONMENT CONTROL

A ventilation system in the canopy is provided for the supply of fresh air to the cabin. The bad weather window is equipped with a ventilation scoop to provide supply of fresh air to the cabin. Additionally, to the left and right of the cockpit eyeball-type adjustable vents are installed.

Left blank intentionally

SECTION 8

HANDLING, SERVICING AND MAINTENANCE

Table of Contents

<i>Paragraph</i>		<i>Page</i>
8.1	INTRODUCTION	8-3
8.2	AIRPLANE INSPECTION PERIODS	8-3
8.3	PILOT CONDUCTED PREVENTIVE MAINTENANCE	8-3
8.4	ALTERATIONS OR REPAIR	8-3
8.5	SERVICING	8-3
8.6	GROUND HANDLING	8-4

Left blank intentionally

SECTION 8

HANDLING, SERVICING AND MAINTENANCE

8.1 INTRODUCTION

- a) The airplane owner should establish contact with the dealer or certified service station for service and information.
- b) All correspondence regarding the airplane must include its serial number which is stamped on a plate on the L/H rear part of the fuselage.
- c) A service manual with revision service may be procured from the manufacturer.

8.2 AIRPLANE INSPECTION PERIODS

As required by national operating rules all airplanes must pass a complete annual inspection every twelve calendar months. In addition to the annual inspection airplanes must pass a complete inspection after every 100 flights hours with a minor check after 50 and 25 hours.

The Airworthiness Authority may require other inspections by the issuance of airworthiness directives applicable to the aircraft, engine, propeller and components. The owner is responsible for compliance with all applicable airworthiness directives and periodical inspections.

8.3 PILOT CONDUCTED PREVENTIVE MAINTENANCE

Pilots operating the airplane should refer to the regulations of the country of certification for information of preventive maintenance that may be performed by pilots. All other maintenance required on the airplane is to be accomplished by appropriately licensed personnel. Airplane dealer should be contacted for further information

Preventive maintenance should be accomplished with the appropriate service manual.

8.4 ALTERATIONS OR REPAIR

Alterations or repairs of the airplane must be accomplished by licensed personnel.

8.5 SERVICING

In addition to the airplane inspection periods (8.2) information for servicing the aircraft with proper oil and fuel is covered in Section 2 (Limitations) and Section 7 (Descriptions and Operation).

8.6 GROUND HANDLING

- a) Due to its low weight and the free swiveling tail wheel two persons can easily move the airplane by hand.

- b) To tie down the airplane M6 nut plates are provided in the wing tips where ring bolts can be screwed in. The tail wheel leg can be used as third point to tie down the airplane. If the aircraft is parked in the open, it must be protected against the effects of weather, the degree of protection depending on severity of the weather conditions and the expected duration of the parking period. When the airplane is parked in good weather conditions for less than a half day park the aircraft headed into the wind and place wheel chocks at the main wheels.

- c) To level the aircraft, the tail wheel is rested on a balance and jacked to a position that the fuselage reference line (upper fuselage stringer tube) is horizontal. There are two engine hoists provided on the top of the engine which can be used to lift the airplane with a crane. (Tail wheel resting on ground)

SECTION 9

SUPPLEMENTS

Doc-No. EA-04701.1

Table of Contents

Section		Pages
9	Supplements	4 p.
901	<input type="checkbox"/> Steerable Tail Wheel	4 p.
902	<input type="checkbox"/> Electronic Accelerometer	10 p.
903	<input type="checkbox"/> Emergency Locator Transmitter	8 p.
904	<input type="checkbox"/> External Power	6 p.
905	<input type="checkbox"/> Digital RPM Indicator	6 p.
906	<input type="checkbox"/> Long Range Wing Tank Capacity	6 p.
907	<input type="checkbox"/> Airtow Hook	8 p.
908	<input type="checkbox"/> Smoke System	6 p.
909	<input type="checkbox"/> Reserved	
910	<input type="checkbox"/> Reserved	
911	<input type="checkbox"/> Reserved	
912	<input type="checkbox"/> FILSER TRT 600 Transponder	8 p.
913	<input type="checkbox"/> FILSER TRT 800 Transponder	8 p.
914	<input type="checkbox"/> GARMIN GTX 327 Transponder	6 p.
915	<input type="checkbox"/> GARMIN GTX 330 Transponder	8 p.
916	<input type="checkbox"/> BENDIX/KING KT 76A Transponder	6 p.
917	<input type="checkbox"/> BENDIX/KING KT 73 Transponder	8 p.
918	<input type="checkbox"/> BECKER ATC 2000 Transponder	6 p.
919	<input type="checkbox"/> BECKER ATC 4401 Transponder	8 p.
920	<input type="checkbox"/> BECKER BXP 6401 Transponder	10 p.

Left blank intentionally

9 SUPPLEMENTS

9.1 INTRODUCTION

Section 9 "Supplements" of the Pilot's Operating Handbook contains all information, necessary for a safe and efficient operation of the airplane when equipped with one or more of the various optional systems and equipment not provided with the standard airplane.

9.2 NOTES

The described systems and equipment are certified by the LBA for the *EXTRA 300/S*. Pages and contents of this section may not be exchanged and alterations of or additions to the approved contents may not be made without the EXTRA Flugzeugproduktions- und Vertriebs-GmbH/LBA approval. The editor has the copyright of these Supplements and is responsible for edition of revisions. The log of effective pages is found under section 0.4 of this Pilot's Operating Handbook.

Each Supplement section (e.g. steerable tailwheel) covers only a single system, device, or piece of equipment and is a self-contained, miniature Pilot's Operating Handbook. The owner is responsible for incorporating prescribed amendments and should make notes about these on the records of amendments. It is responsibility of the pilot to be familiar with the contents of relevant supplements.

POH Supplements must be in the airplane for flight operations when the subject equipment is installed or special operations are to be performed.

The Table of Contents shows all EXTRA Supplements available for the EXTRA 300/S. A check mark in the *Section* column indicates that the corresponding supplement must be included in this POH.

Left blank intentionally

SECTION 901

STEERABLE TAIL WHEEL

Table of Contents

<i>Paragraph</i>		<i>Page</i>
901.1	GENERAL	901-3
901.2	LIMITATIONS	901-3
901.3	EMERGENCY PROCEDURES	901-3
901.4	NORMAL PROCEDURES	901-3
901.5	PERFORMANCE	901-3
901.6	WEIGHT AND BALANCE	901-3
901.7	DESCRIPTION OF THE SYSTEM	901-3
901.8	HANDLING, SERVICING AND MAINTENANCE	901-4

Left blank intentionally

901 STEERABLE TAIL WHEEL

901.1 GENERAL

To improve taxi and handling quality, the EXTRA 300/S can be equipped with an optional steerable tailwheel. The deflection angle of this tailwheel is arranged by the rudder control up to plus/minus 30°. Exceeding this deflection the tailwheel has a full-swivel capability by a release mechanism.

901.2 LIMITATIONS

The operation limitations are not effected due to the use of the steerable tailwheel.

901.3 EMERGENCY PROCEDURES

There is no change of basic emergency procedures with the installation of the steerable tailwheel.

901.4 NORMAL PROCEDURES

There are no changes for the described normal procedures after installation of the steerable tailwheel. In addition to the existing normal procedures the light precompression of connector springs and movement of the rudder have to be checked during the preflight check.

901.5 PERFORMANCE

Changes in flight performance due to installation of the steerable tailwheel are not noticeable. The given basic performance data under section 5 are still valid.

901.6 WEIGHT AND BALANCE

A change of the running empty weight and resulting C/G position after installation of the steerable tailwheel is neglectable, because of minor differences in weight and C/G between standard and optional steerable tailwheel.

901.7 DESCRIPTION OF THE SYSTEM

The 5 inch tailwheel has a solid rubber tire and is rotatable by means of a wheelfork, which is connected to a bearing steelsleeve. This steelsleeve itself contains also the release mechanic, which gives the wheelfork a full-swivel capability exceeding plus/minus 30° deflection. The steelsleeve is glued into the glasfiberspring, which is bolted to the tail hardpoint of the aircraft. The steering of the tailwheel is accomplished by a direct mechanic link (rudder control cable) from the rudder pedals. The steering deflection of the tailwheel is controlled by the rudder movement and dampened by anti shimmy connector springs.

901.8 HANDLING, SERVICING AND MAINTENANCE

During 50 hour inspection, the bearing steelsleeve has to be lubricated on the point of lubricating. Additionally all parts of the tailwheel have to be inspected visually for deformations, cracks and corrosion.

SECTION 902

ELECTRIC ACCELEROMETER

Table of Contents

<i>Paragraph</i>		<i>Page</i>
902.1	GENERAL	902-3
902.2	LIMITATIONS	902-3
902.3	EMERGENCY PROCEDURES	902-3
902.4	NORMAL PROCEDURES	902-3
902.5	PERFORMANCE	902-3
902.6	WEIGHT AND BALANCE	902-3
902.7	DESCRIPTION AND OPERATION OF THE SYSTEM	902-3
902.8	HANDLING, SERVICING AND MAINTENANCE	902-9

Left blank intentionally

902 ELECTRONIC ACCELEROMETER

902.1 GENERAL

The standard equipped accelerometer typ AN 5745 can be replaced by an optional "Digital Solid State Accelerometer DSA 12".

902.2 LIMITATIONS

The instrument markings and placards are provided for the acrobatic category only; for the normal category refer to corresponding limitations.

Any exceedance of given limitations have to be reported by the pilot and considered by corresponding maintenance or inspection procedure according to the *SERVICE MANUAL EA 300/S*.

Instrument markings

Electronic Accelerometer DSA 12

red range	-12 g	-	-10 g
yellow range	> -10 g	-	-8 g
green range	> -8 g	-	< +8 g
yellow range	+8 g	-	< +10 g
red range	+10 g	-	+12 g

902.3 EMERGENCY PROCEDURES

Not affected.

902.4 NORMAL PROCEDURES

Not affected.

902.5 PERFORMANCE

Not affected.

902.6 WEIGHT AND BALANCE

Not affected.

902.7 DESCRIPTION AND OPERATION OF THE SYSTEM

The DSA 12 accelerometer measures acceleration in one certain direction. The measuring range is between +20g and -20g. A clock inside the instrument measures time and date. One of the output-displays is an LCD with two lines and eight positions per line. Positive values of accelerations are always shown in the upper line of the LCD, and negative values of acceleration always in the bottom line.

The other output-display are twentyfive LEDs which are arranged in a semicircle. The upper twelve LEDs show positive acceleration, the lower twelve LEDs show negative acceleration. The middle LED is on line all time long.

INSTANTANEOUS ACCELERATION

The current value of acceleration is called **Instantaneous Acceleration**. It is shown by the LED-display if the value is between +12g and -12g. If the "Instantaneous Acceleration" is zero g, only the middle LED lights up. Every single g illuminates one more LED in positive (up) or negative (down) direction. For example:

The "Instantaneous Acceleration" is +5g, the middle LED and five LEDs in positive direction are illuminated. If the "Instantaneous Acceleration" is -7g, the middle LED and seven LEDs in negative direction are illuminated. In case the absolute value of the "Instantaneous Acceleration" is greater then 12g all twelve LEDs of this range are turned on.

CURRENT EXTREME VALUES "A"

A permanent illumination of two LEDs, one for positive acceleration and another one for negative acceleration, shows the **Current Extreme Values**. They are signed by two illuminated LEDs, one in the positive and one in the negative range. These two "Current Extreme Values" are shown furthermore on the LC-Display in case of normal operation (the positive "Current Extreme Value" is shown in the upper line, and the negative "Current Extreme Value" is shown in the lower line).

They are both signed by an "A" as first character of every line. The "Current Extreme Values" change, if the "Instantaneous Acceleration" is greater than the last positive or lower than the last negative "Current Extreme Value" (the positive or the negative). The "Current Extreme Values" can be reset to 0g by pushing the buttons.

TOTAL EXTREME VALUE "B"

Eventhough the two "Current Extreme Values" are reset to 0g, there will remain a positive and a negative **Total Extreme Value** in the memory. As soon as a "Current Extreme Value" occurs that is greater than the positive or lower than the negative "Total Extreme Value", the corresponding "Total Extreme Value" is exchanged with the "Current Extreme Value". This is a possibility to store the positive and the negative "Total Extreme Value" during different actions, while the "Current Extreme Values" are reseted to 0g after every single action.

The "Total Extreme Values" can be shown or reseted to 0g by pushing the buttons. They are signed with a "B" as the first character on every LC-Display line.

The "Total Extreme Values" only change if one of them is lower than the corresponding "Current Extreme Value" or if they are reset to 0g.

Here is an example: Since the last reset of the "Current Extreme Values" and the "Total Extreme Values" the maximum of the positive acceleration was +9g and the maximum of the negative acceleration was -5g. The "Instantaneous Acceleration" is +3g. Therefore the middle LED and the first three positive LEDs are illuminated for the "Instantaneous Acceleration". Furthermore the ninth LED in positive direction is illuminated for the positive "Current Extreme Value", and the fifth LED in negative direction for the negative "Current Extreme Value".

The LC-Display shows:

A	+ 9.0 g
A	- 5.0 g

After resetting the "Current Extreme Values", the LC-Display shows

A + 3.0 g
A - 0.0 g

and only the middle LED and three LEDs in the positive range of the LED-Display are shining. If the display presents the "Total Extreme Value" you will see

A + 9.0 g
A - 5.0 g

on the LC-Display, because the "Total Extreme Values" has not changed.

The "Total Extreme Values" only change if one of them is lower than the corresponding "Current Extreme Value" or if they are reset to 0g.

ABSOLUTE EXTREME VALUES "C"

Two further extreme acceleration values are the positive and the negative **Absolute Extreme Value**. These values are the greatest acceleration values that ever occurred. They can not be reset and they are stored in the long-term memory inside the instrument. Additionally, time and date these "Absolute Extreme Values" occurred are stored. These dates can be shown by the LC-Display by pushing the buttons.

The output of the "Absolute Extreme Values" is signed by a "C" as first character of the two LC-Display lines. The "Absolute Extreme Values" only change, if an "Instantaneous Value" occurs that is greater than the positive "Absolute Extreme Value" or lower than the negative "Absolute Extreme Value".

TIME AND DATE

You can recall the current **time** and **date** by pushing the buttons. If you want to change the current time and date of the clock, you have to enter the security code by the buttons. In Case the code is wrong or you wait too long, the instrument will return into the "Normal Operating Mode". The clock module has its own battery power supply backup, preventing the clock from stopping even in case of turning off the master switch or disconnecting the DSA 12 from the electrical system of the aircraft.

OPERATING INSTRUCTIONS

The left button of the instrument will be called S1 and the right button will be called S2 during the following text. If the LC-Display shows acceleration values, then the upper line exhibits the positive acceleration, and the lower line shows the negative acceleration. If the LC-Display presents time and date, you will see the time in the upper line, and in the lower line you will see the date.

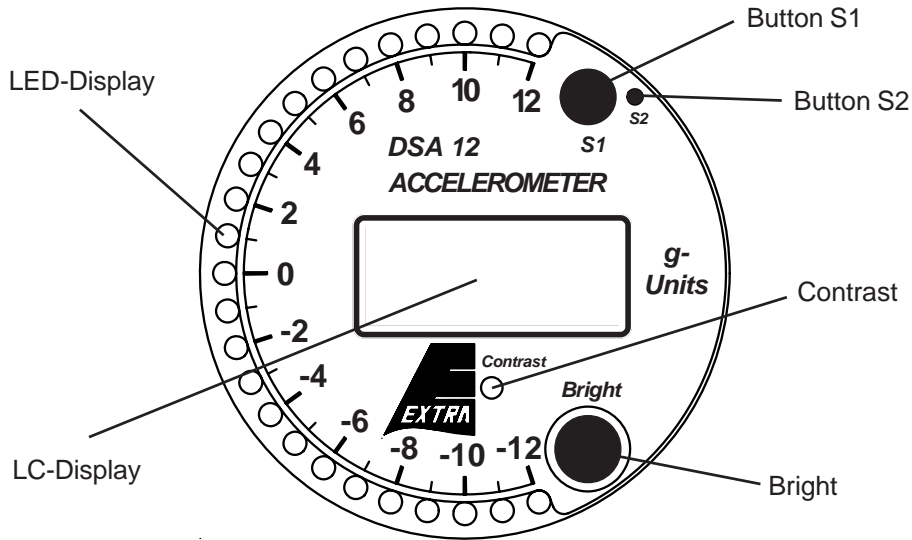

1) THE FIRST SECONDS AFTER THE POWER ON

All LEDs are lighted up during the first two seconds after the power on of the instrument. Both the "Current Extreme Value" and the "Total Extreme Value" are reset to 0g. The LCD shows:

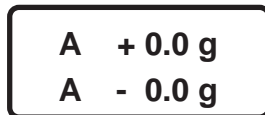

After two seconds the Instrument changes automatically into the "Normal Operating Mode".

2) THE "NORMAL OPERATING MODE"

In the "Normal Operating Mode" the instrument outputs the "Instantaneous Acceleration" and the "Current Extreme Values". The "Instantaneous Acceleration" is shown as a bar on the LED-Display. Furthermore one LED indicates the positive and another one indicates the negative "Current Extreme Value". The "Current Extreme Values" are also shown on the LC-Display and signed with an "A", for Example:

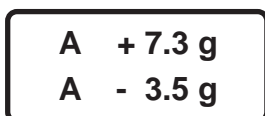

3) RESET OF THE "CURRENT EXTREME VALUES"

Push button: once S1

If you want to reset the "Current Extreme Value" to 0g (for example you want to measure the extreme values of the next flight figure), you have to push S1 once. In this case, all LEDs are lighting up for two seconds, the LC-Display is showing:

A	+ 0.0 g
A	- 0.0 g

and the "Current Extreme Value" is reset to 0g.
On condition you push S1 for another time during this two seconds, you get to other submenus, else the instrument returns into the "Normal Operating Mode".
All LEDs are illuminated during the submenus.

4) DISPLAY OF THE "TOTAL EXTREME VALUES"

Push button: twice S1

Reset of the "Total Extreme Values"

Push button: twice S1 and once S2 you push S1 twice, the LC-Display shows the "Total extreme values". These values are the maximums of positive and negative acceleration that occurred since the last reset of these values. They are signed with a "B" as first character of a line, like the following example:

B	+ 8.4 g
B	- 4.2 g

In case you want to reset these two values, you have to press S2 and the instrument sets the "Total extreme values" to 0g and returns into the "Normal Operating Mode". Provided you pushed S1 instead of S2, the LC-Display will show the "Absolute Extreme Values".
If there is no button pushed, the instrument will return into the "Normal Operating Mode".

5) DISPLAY OF THE "ABSOLUTE EXTREME VALUES"

push button: three times S1
Display of time and date of the "Absolute Extreme Values"

push button: three times S1 and once S2

After pushing S1 for three times, the LC-Display shows the greatest positive and the greatest negative acceleration the instrument ever measured. These two values are stored in the long-term memory of the instrument and signed with a "C" as first character of the LC-Display:

C	+ 9.6 g
C	- 8.3 g

Additionally the long-term memory stores the times and dates when new "Absolute Extreme Values" occur. They are shown if you push S2 next. In this case during the next twelve seconds the LC-Display shows under the title "MAX-DATE" the time and date of the positive "Absolute Extreme Value" and under the title "MIN-DATE" the time and date of the negative "Absolute Extreme Value". Afterwards the instrument returns into the "Normal Operating Mode".

If you push S1 instead of S2, the LC-Display will show the current time and date.

If there is no button pushed for about five seconds, the instrument will return into the "Normal Operating Mode".

6) OUTPUT OF TIME AND DATE

push button: four times S1

The LC-Display will exhibit time and date after you have pushed S1 for four times. For example:

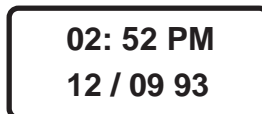

02: 52 PM
12 / 09 93

is the ninth December 1993 at 2 o'clock and 52 minutes in the afternoon. If you want to set the clock, you have to push S1 for another time, otherwise the instrument returns into the "Normal Operating Mode".

7) SETTING OF THE CLOCK

push button: five times S1

You can only set the clock, if you know the right four digit code.

If you push S1 for five times, the LC-Display shows a request to enter the code. You can change the code-digit by pushing S2. To confirm your input of a digit you have to push S1. If the entered code-digits are wrong, or you wait longer than six seconds, the instrument will return into the "Normal Operating Mode".

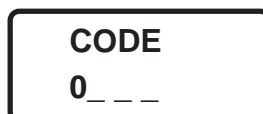

CODE
0 _ _ _

Provided it was the right code, the LC-Display shows the current time and date with a cursor under the first digit. By pushing S2 you can change the digit. The change can be confirmed by pushing S1. In this case the cursor moves to the next digit. The instrument changes into the "Normal Operating Mode", if you have stepped through all digits with the cursor, or you waited more than six seconds without pushing a button. In this case the time and date on the display are transferred into the clock. If you try to enter an impossible number (like 18 as months or 35 as days), the instrument turns

back into the "Normal Operating Mode" and the clock will be programmed with the correct changed numbers. The wrongly changed number is exchanged by its old value.

902.8 HANDLING, SERVICING AND MAINTENANCE

If the absolute extreme value "C" indicates that the operating limits have been exceeded, the manufacturer must be informed. The battery inside, which is used for the clock power supply backup, is expected to have a lifetime of 5 to 10 years. A weak battery can be exchanged by the manufacturer only.

Left blank intentionally

SECTION 903

EMERGENCY LOCATOR TRANSMITTER

Table of Contents

<i>Paragraph</i>		<i>Page</i>
903.1	GENERAL	903-3
903.2	LIMITATIONS	903-3
903.3	EMERGENCY PROCEDURES	903-4
903.4	NORMAL PROCEDURES	903-6
903.5	PERFORMANCE	903-6
903.6	WEIGHT AND BALANCE	903-6
903.7	DESCRIPTION AND OPERATION OF THE SYSTEM	903-6
903.8	HANDLING, SERVICING AND MAINTENANCE	903-7

Left blank intentionally

903 EMERGENCY LOCATOR TRANSMITTER

903.1 GENERAL

To improve the passive security, the EXTRA 300/S can be equipped with an optional Emergency Locator Transmitter POINTER 3000 ELT. This POINTER 3000 ELT transmits automatically after a crash or manual activity on the emergency frequencies of 121.5 MHz (civilian) and 243.0 MHz (military).

903.2 LIMITATIONS

The operation limitations are not effected due to the installation of the POINTER 3000 ELT. For the location and operation of the transmitter the following placards have to be attached in the aircraft:

ELT located here - placard outside on the left fuselage board in high of the ELT-unit,

ELT - placard above the ELT- circuit breaker (see Fig.1) ,

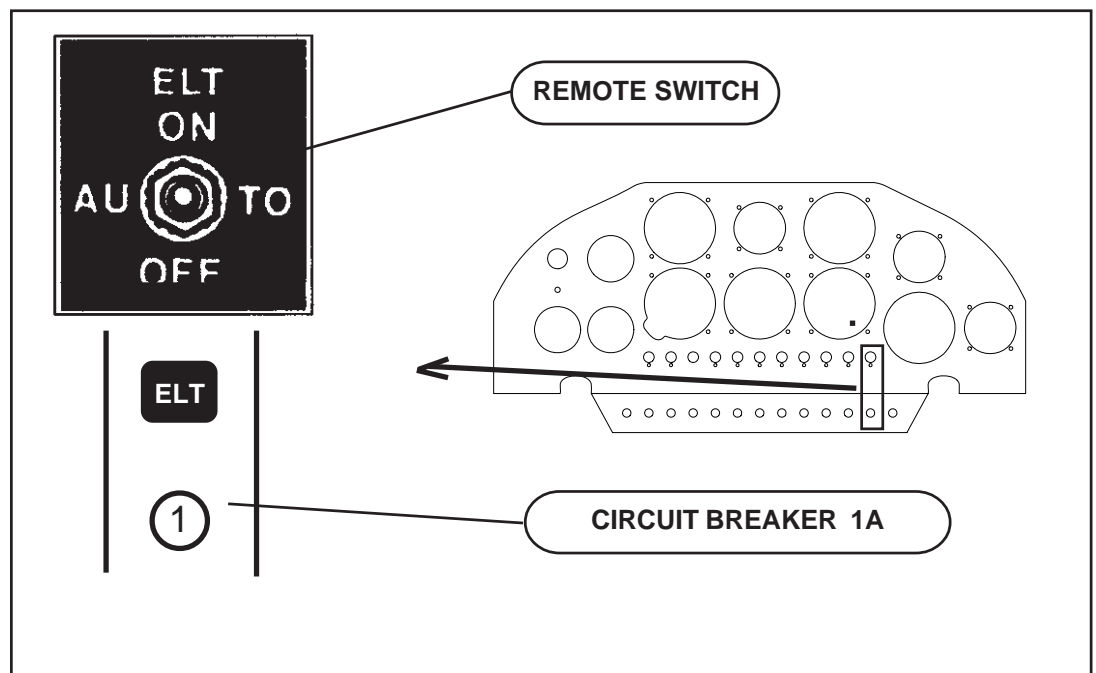
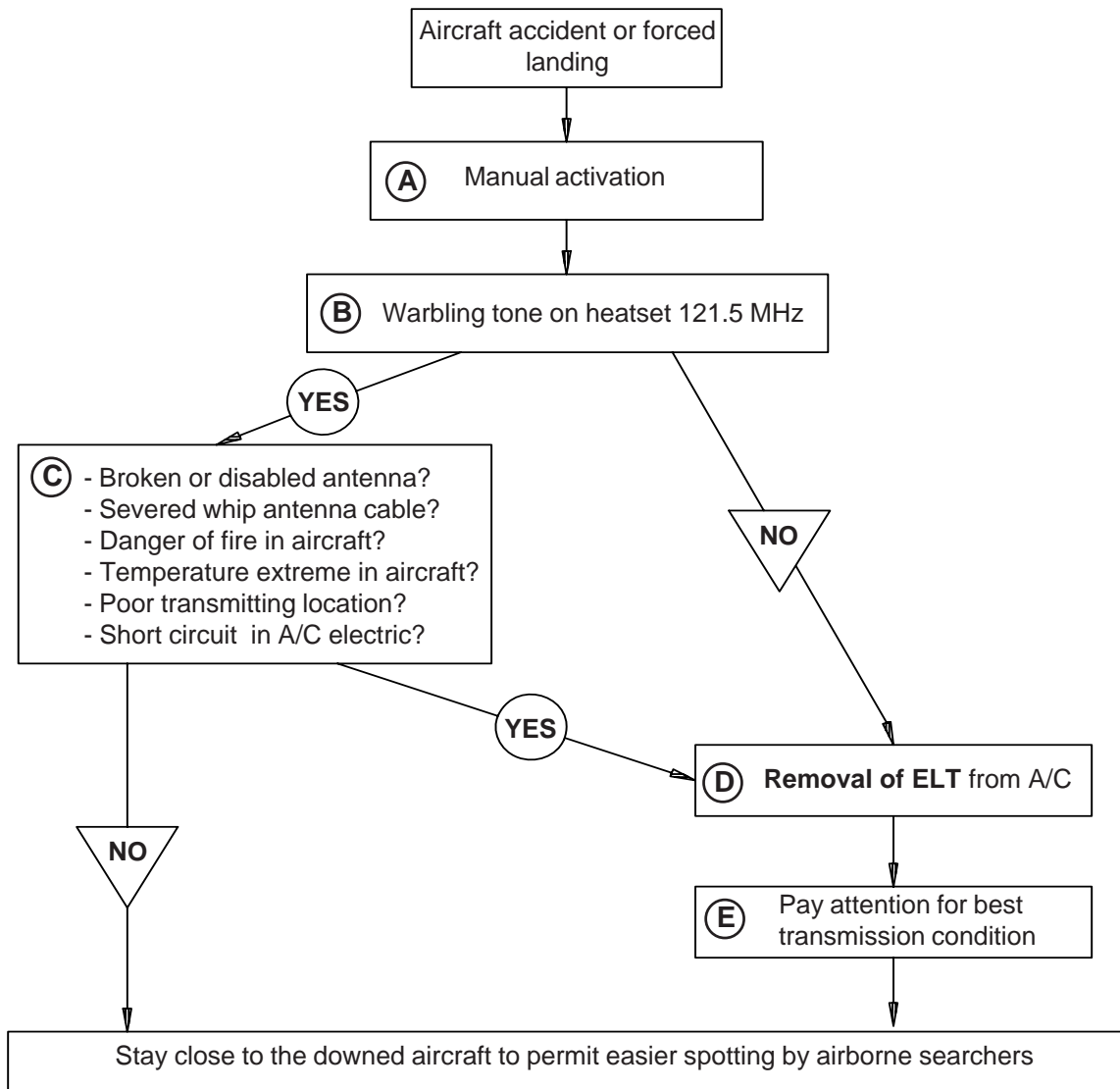

Figure 1

903.3 EMERGENCY PROCEDURES



A) Automatic and manual activation

Although the ELT will be activated automatically by a *ROLAMITE* Type INTERTIA switch after an aircraft accident or forced landing with high G-force, turn additionally the remote switch (optional) in the rear panel or the unit master switch at the ELT unit to "ON" position. The ELT will send a signal on the emergency frequencies of 121.5 MHz and 243.0 MHz.

B) Control of the ELT

If the aircraft receiver is operable listen on 121.5 MHz for ELT transmission. Ensure that whip antenna is clear of obstruction.

C) Operating of the ELT in the portable mode

After forced landing or aircraft accident it may be desirable to use the transmitter in the portable mode. Various reasons may necessitate this, such as:

- | | | |
|--|---|-----------------------|
| - Broken or disabled whip antenna: | ⇒ | Ⓓ REMOVE ELT FROM A/C |
| - Severed whip antenna cable: | | " |
| - Danger of fire or explosion in aircraft: | | " |
| - Temperature extremes in aircraft: | | " |
| - Poor transmitting location: | | " |

D) Removal of ELT from aircraft:

NOTE

Accomplish as quickly as possible to resume or start emergency signal.

1. Turn the unit master switch to "**OFF**"-position
2. Disconnect whip antenna cable and remote switch cable
3. Turn winged nut on rear bracket clip to release transmitter (remove ELT)
4. Remove the telescope antenna from the stowage clips and insert into the ANT receptacle. Extend antenna fully.

CAUTION

5. Turn unit master switch to "**ON**" position. Do not use the "AUTO"position!

E) Best transmission may be obtained by:

- Keeping antenna vertical,
- Standing transmitter upright on a metallic surface, such as an aircraft wing or stabilizer
- If terrain prohibits good transmission (such as a deep valley or canyon) place the Transmitter on the high ground or hold in hand on high place
- Stay close to the downed aircraft
- In freezing weather, place transmitter inside jacket or coat to keep the battery warm. Let the antenna extend outside jacket.
- Keep all moisture and ice away from the antenna connection and the remote connector pins.

CAUTION

Do not turn POINTER portable "**OFF**" - even by night as search aircraft may be enroute around the clock. Even when you have been sighted or think you have, the spotting aircraft may not be able to relay an accurate or timely "fix" on your position without a continued signal.

Only when the rescue team appears discontinue signalling by using the "OFF" position.

903.4 NORMAL PROCEDURES

There is no change of basic normal procedures with the installation of the POINTER 3000 ELT. In addition to the existing normal procedures the "AUTO" position of the unit master switch or the remote switch has to be checked during the preflight check.

903.5 PERFORMANCE

Not affected.

903.6 WEIGHT AND BALANCE

Not affected.

903.7 DESCRIPTION AND OPERATION OF THE SYSTEM

The used Emergency Locator Transmitter is a POINTER 3000 ELT from the POINTER INC., Tempe, Arizona. After an activation the necessity signal is transmitted on the 121,5 MHz and the 243.0 MHz for a period of 48 hours at -20° respectively 2 hours at +50°. The Inertia-switch releases the necessity signal after a G-force of $5 \pm 2/0$ g in aircraft-longitudinal axis and a duration of $11 \pm 5/0$ g milliseconds. When properly installed, parallel to the line of flight, the ELT will not activate due to turbulence, normal operation, or aerobatics.

POINTER PORTABLE ELT MAYOR SYSTEM COMPONENTS

The POINTER PORTABLE ELT System consists of the following components:

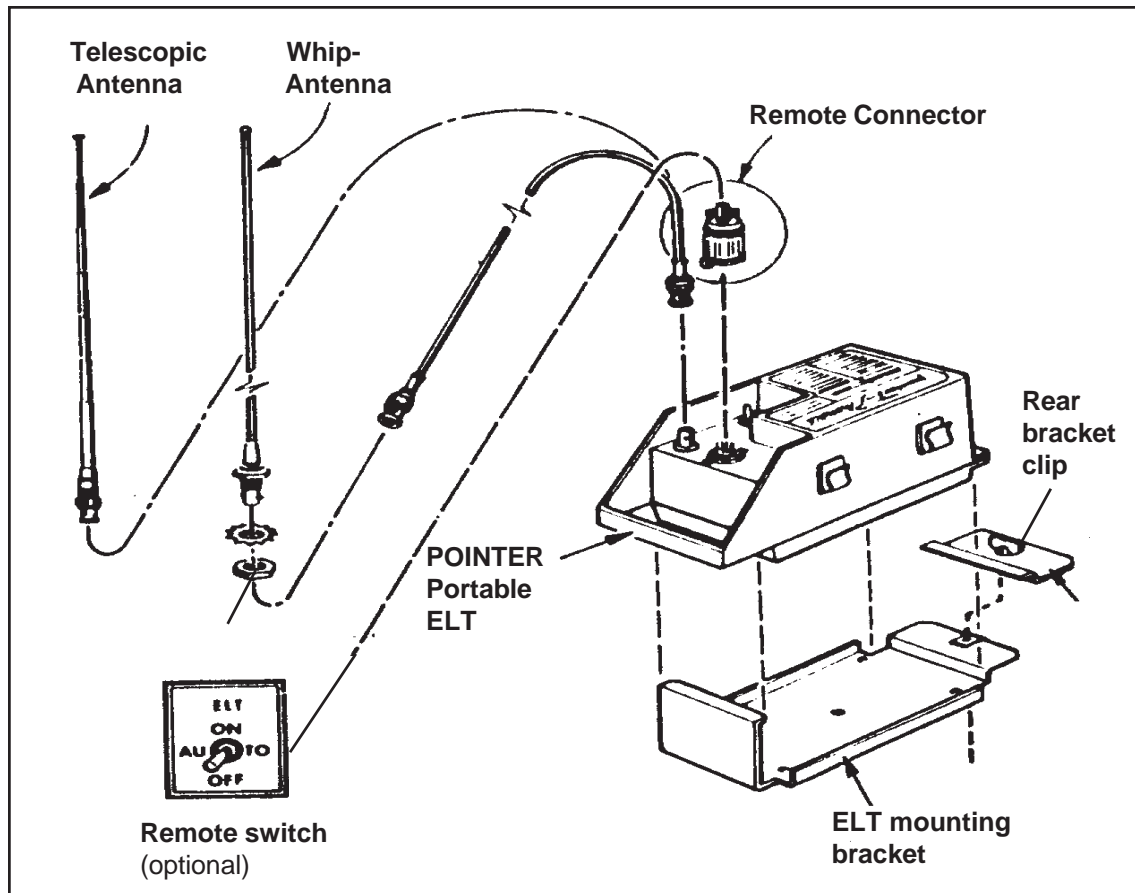

OPERATING INSTRUCTION OF THE TRANSMITTER

The operation of the ELT is possible over the master unit switch or over the remote switch (optional) in the panel.

UNIT MASTER SWITCH

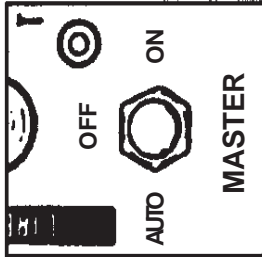

ON: used to activate the transmitter for test or emergency situations

OFF: used to de-activate transmitter or to insure non-activation by handling

AUTO: used to arm the Pointer Portable for automatic activation by the "G" switch only.

REMOTE SWITCH (optional)



ON: used to remotely activate the transmitter for test or emergency situation. An example of such an emergency situation would be forced landing with an impact insufficient to activate the Rolamite "G"-switch.

AUTO: used to arm the Pointer Portable for automatic activation by the "G" switch only.

OFF: used to de-activate transmitter after automatic activation by the "G"-switch

903.8 HANDLING, SERVICING AND MAINTENANCE

Visually inspect the unit at regular intervals for cleanliness and secureness.

Check whip antenna mounting and cable connections for tightness.

In accordance with FAA regulations, batteries must be replaced after 2 years shelf or service life or for any of the following reasons:

- after the transmitter has been used in emergency situation (including any inadvertent activation of unknown duration),
- after the transmitter has been operated for more than one cumulative hour,
- on or before battery replacement date.

Left blank intentionally

SECTION 904

EXTERNAL POWER

Table of Contents

<i>Paragraph</i>		<i>Page</i>
904.1	GENERAL	904-3
904.2	LIMITATIONS	904-3
904.3	EMERGENCY PROCEDURES	904-3
904.4	NORMAL PROCEDURES	904-3
904.5	PERFORMANCE	904-4
904.6	WEIGHT AND BALANCE	904-4
904.7	DESCRIPION OF THE SYSTEM	904-4
904.8	HANDLING, SERVICING AND MAINTENANCE	904-5

Left blank intentionally

904 EXTERNAL POWER

904.1 GENERAL

The EXTRA 300S can be equipped with two versions of an optional external power receptacle system. The "normal" system (PN 93102.16-01) provides the capability to start the engine independent of the board battery and is limited to this use. The "continuous operation" system (PN 93102.16-02) further allows feeding the electrical system for longer periods.

904.2 LIMITATIONS

The operation limitations are not affected due to the installation of the external power receptacle system. For the location of the external power receptacle and protection of the electrical connection cable against overheating the following placard has to be attached on the rear instrument panel with an indicator arrow to the receptacle:

EXTERNAL POWER 12V
DO NOT CRANK FOR MORE THAN 10 SECONDS!
Allow 20 seconds to cool-down between attempts. Repeat up to 6 times.
Then let starter cool for 30 minutes.

904.3 EMERGENCY PROCEDURES

Not affected.

904.4 NORMAL PROCEDURES

The following starting procedures are recommended, however, the starting conditions may necessitate some variation from these procedures.

1. Perform Pre-flight inspection.
2. Set propeller governor control to "High RPM" position.
3. Open throttle approximately 1/4 travel.
4. **Master switch "OFF"**
5. Put the external power plug into the board receptacle
6. Turn boost pump "ON".
7. Move mixture control to "FULL RICH" until a slight but steady fuel flow is noted (approximately 3 to 5 seconds) and return mixture control to "IDLE CUT-OFF".

Turn boost pump "OFF".

CAUTION

**Pay attention to objects and persons in the propeller operating area!
Hold the canopy tight!**

8. Apply the brakes.
9. Engage starter.
10. When engine fires release the ignition switch back to "BOTH".
11. Pull the external power plug from the board receptacle.
12. Move mixture control slowly and smoothly to "FULL RICH".

13. Check the oil pressure gauge. If minimum oil pressure is not indicated within 30 seconds, shut off the engine and determine trouble.

14. Master switch "ON".

904.5 PERFORMANCE

Not affected.

904.6 WEIGHT AND BALANCE

Not affected.

904.7 DESCRIPTION OF THE SYSTEM

The external power receptacle is attached left under the rear seat. The main-relais is located at the left side of the firewall, above the starter-relais. For the avoidance of sparks, this relais does not switch before a safe contact from plug to receptacle will be ensured. During the engine start, the master switch has to be switched in "OFF"-position for the disconnection of the battery from the aircraft electric circuit.

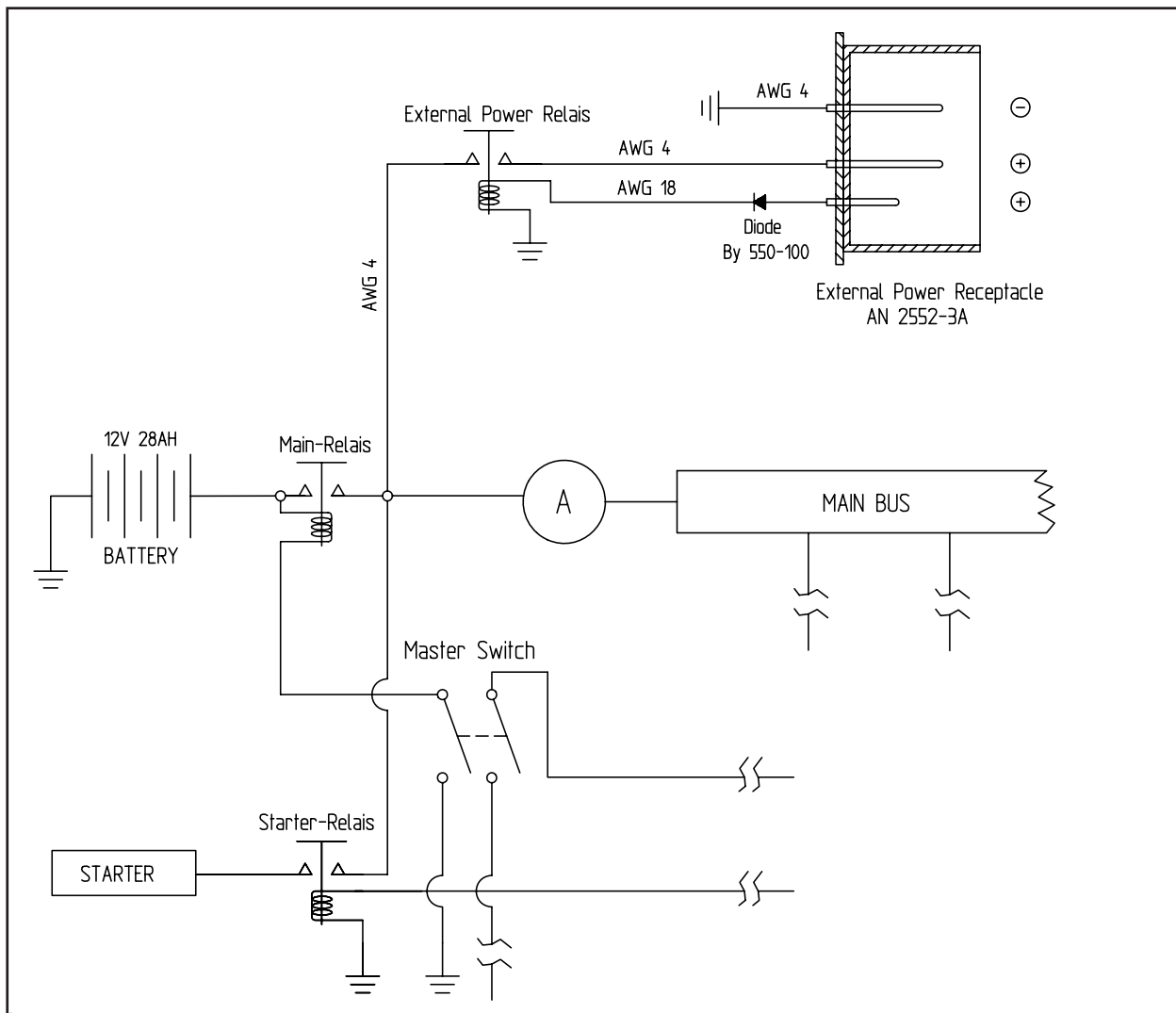

904.8 HANDLING, SERVICING AND MAINTENANCE

Not affected.

Left blank intentionally

SECTION 905

DIGITAL RPM INDICATOR

Table of Contents

<i>Paragraph</i>		<i>Page</i>
905.1	GENERAL	905-3
905.2	LIMITATIONS	905-3
905.3	EMERGENCY PROCEDURES	905-3
905.4	NORMAL PROCEDURES	905-3
905.5	PERFORMANCE	905-4
905.6	WEIGHT AND BALANCE	905-4
905.7	DESCRIPTION OF THE SYSTEM	905-4
905.8	HANDLING, SERVICING AND MAINTENANCE	905-6

Left blank intentionally

905 DIGITAL RPM INDICATOR

905.1 GENERAL

The EXTRA 300/S can be equipped with the optional "P-1000" Digital RPM indicator alternatively to the mechanical VDO RPM indicator.

905.2 LIMITATIONS

The operation limitations are not affected due to the installation of the "P-1000" Digital RPM indicator. The face of the indicator is placarded with the unchanged Engine RPM operating range. Additionally the operating RPM ranges are indicated on the large green, yellow, and red LEDs. These LEDs are located on the upper right corner of the indicator face.

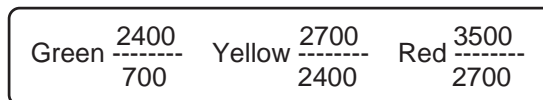

905.3 EMERGENCY PROCEDURES

Not affected.

905.4 NORMAL PROCEDURES

The *Normal Procedures* have to be changed in Chapter "4.5 Take-Off Procedure" section "4.5.1. Before take off". If the P-1000 RPM indicator is installed, the mag-drop test has to be carried out in the following manner:

Magneto check

Engine RPM: 1800 min⁻¹

Pay attention to the three small LEDs in the "Status" area on the upper left corner of the P-1000 face:

Ignition switch position:	LEFT
Status area:	Left red LED illuminates
Display:	shows RPM drop

Ignition switch position:	RIGHT
Status area:	Right red LED illuminates
Display:	shows RPM drop

Ignition switch position:	BOTH
Status area:	Right and left red LED off illuminate
	The middle LED is not allowed to alert, otherwise the difference is more than permissible.

NOTE

During the short circuit (grounding) of a single magneto, the respective red LED has to be illuminated. The maximal allowed RPM drop at 1800 min⁻¹ is 175 min⁻¹. The maximal difference between the magnetos has not to be over 50 RPM (identify with the illuminated yellow LED).

905.5 PERFORMANCE

Not affected.

905.6 WEIGHT AND BALANCE

Not affected.

905.7 DESCRIPTION OF THE SYSTEM

The operation of the indicator is straight-forward. After power is supplied to the indicator, the engine is started, and the self tests are performed, the default display of the engine RPM appears on the display. The default display is insured via the use of internal timers that will restore the display to the current RPM even in the event that one of the panel buttons becomes stuck or defective.

Internally, two independent tachometers watch the pulses received from each magneto. Each tachometer is accurate to less than 1 RPM and can be individually enabled/disabled via buttons on the face of the indicator.

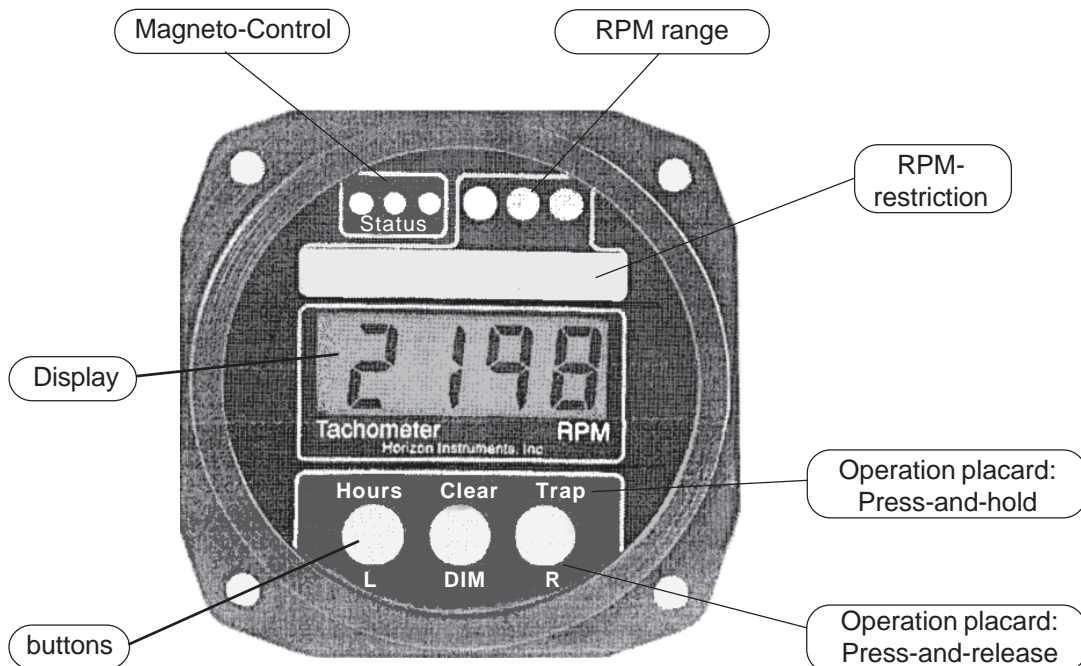

RPM RANGES

Engine operating ranges are indicated on the large green, yellow, and red LEDs. This LEDs are located on the upper right corner of the indicator face.

MAGNETO-CHECK

Three small LED magneto system alert indicator lights are located within the "Status" area on the upper left corner of the indicator face.

The left and right red LED alert indicator lights, when illuminated, indicate, because of loss of ignition signal to the tachometer, a possible malfunction of the respective left or right

magneto ignition system.

While performing a magneto check during engine run-up, the red alert indicator lights will illuminate, thus identifying the grounding of the respective right or left magneto systems.

Ignition switch	Tachometer Magneto	
	Right	Left
Both OFF	ON	ON
Left ON, Right OFF	OFF	ON
Right ON, Left OFF	ON	OFF
Both ON	OFF	OFF

Between the left and right magneto ignition system alert indicators is a yellow **RPM Synchronization indicator**. This small yellow indicator is illuminated when there is a difference of more than 50 RPM between the right and left tachometers.

This indicator also may flicker during extreme RPM excursions of the engine.

OPERATION BUTTONS

There are three panel buttons. Each button has two modes of operation.

PRESS-AND-HOLD operation mode

(press and hold for more than 2/3 of a second)

This operation mode is placarded above each button. (*Hours, Clear, Trap*)

Engine time (Hours)

The left button, upon depression, will cause the tachometer to display the non-fractional portion (0000.) of the current accumulated engine hours. When the button is released, the fractional part of the engine hours (.00) is displayed for a short period of time. The clock is started whenever the engine RPM exceeds 800 RPM and is recorded in real hours.

Clear (Clear)

The middle button clears the RPM trap. During depression of the switch, the RPM trap is zeroed. When the button is released, the trap will record the current engine RPM.

Engine RPM (Trap)

The right button will cause the tachometer to display the current contents of the RPM trap. This trap records the **highest engine RPM** achieved before the button was pressed.

PRESS-AND-RELEASE operation mode

(press and release in less than 2/3 of a second)

This operation mode is placarded below each button. (*L, DIM, R*)

Masks (L, R)

During normal operation, the tachometer presents the average of the left and right internal tachometers on the display. However, a mechanism **exists to mask** either tachometer from the display, leaving the remaining tachometer to determine magneto/ignition problems.

Quickly pressing and releasing the left button (*L*), causes the tachometer to mask the left tachometer.

Quickly pressing and releasing the right button (*R*), causes the tachometer to mask the right tachometer.

Dimmer (*DIM*)

Quickly pressing and releasing the middle button (*DIM*), causes the tachometer to alternately dim or brighten the LED indicators (except the large red LED of the RPM Range).

905.8 HANDLING, SERVICING AND MAINTENANCE

Not affected.

SECTION 906

LONG RANGE WING TANK CAPACITY

Table of Contents

<i>Paragraph</i>		<i>Page</i>
906.1	GENERAL	906-3
906.2	LIMITATIONS	906-3
906.3	EMERGENCY PROCEDURES	906-3
906.4	NORMAL PROCEDURES	906-3
906.5	PERFORMANCE	906-4
906.6	WEIGHT AND BALANCE	906-5
906.7	DESCRIPTION OF THE SYSTEM	906-5
906.8	HANDLING, SERVICING AND MAINTENANCE	906-5

Left blank intentionally

906 LONG RANGE WING TANK CAPACITY

906.1 GENERAL

The leading edge wing tank on the EA 300/S equipped with the long range tank capacity features two tank compartments on either wing side. The compartments are separated by a slosh rib.

906.2 LIMITATIONS

FUEL

Minimum grade aviation gasoline: 100/100LL;
for alternate fuelgrades see latest revision of Lyc. S.I. No. 1070

Total fuel capacity	205 L	(54,1 US Gallons).
- Wingtanks:	154 L (2 x 77 L)	(40,7 US Gallons)
- Acro & Center Tank:	51 L	(13,4 US Gallons)

Usable fuel capacity in the system: **203 L (53,5 US Gallons).**

For acrobatic flight wing tanks must be empty.

Usable fuel capacity for acrobatic: **49 L (12,9 US Gallons).**

WEIGHT LIMITS

Max. allowed **empty** weight - Normal category: 686 kg (1513lbs)

PLACARD

The existing "FUEL SELECTORVALVE"- placard has to be replaced by the following placard:

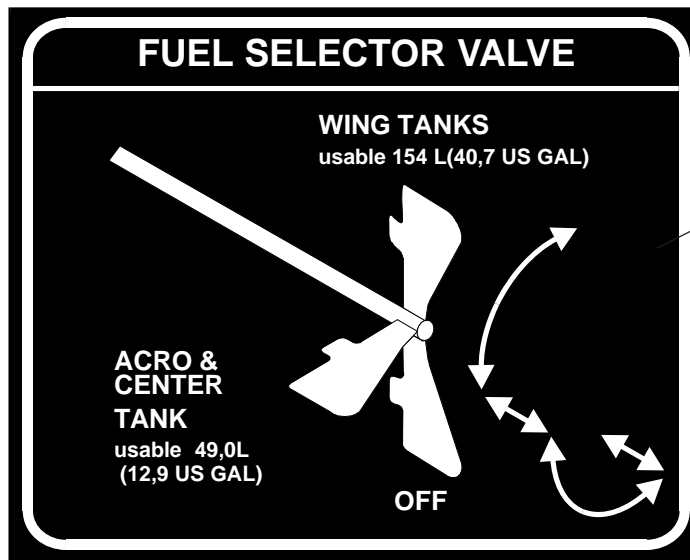

(on right aux. spar hardpoint,
near selector valve handle)

906.3 EMERGENCY PROCEDURES

Not affected.

906.4 NORMAL PROCEDURES

Not affected

906.5 PERFORMANCE

RANGE AND ENDURANCE

Range and Endurance values for a T/O Weight of 920 kg (2028 lbs) including fuel for warm up and Take-Off from SL, max. continuous Power climb to cruising altitude, and a reserve of 21 liters (5.5 US Gal.) for 45 minutes with 45% Power. 2 liters (0,53 US Gal.) unusable fuel is taken into account. (At ISA-Conditions).

PA [ft]	Eng. [RPM]	Manif. Press. [IN HG]	Power Setting		Fuel Consumption		TAS [Kts]	IAS [Kts]	Endur. ① [h]	Range ① [NM]	Mixture ② Best ...
			[%]	[Hp]	[l/h]	[gal/h]					
2000	2400	25,1	75	225	68,7	(18,2)	167,6	160	2.40	401	Power
	2200	24,2	65	195	50,5	(13,3)	159,3	152	3.27	520	Economy
	2000	23,5	55	165	42,6	(11,3)	150,2	144	3.88	582	Economy
	2000	20,2	45	135	36,5	(9,6)	139,9	134	4.52	632	Economy
4000	2400	24,6	75	225	68,7	(18,2)	170,9	158	2.40	408	Power
	2200	23,7	65	195	50,5	(13,3)	162,4	150	3.26	527	Economy
	2000	23,0	55	165	42,6	(11,3)	153,1	142	3.86	589	Economy
	2000	19,7	45	135	36,5	(9,6)	142,6	133	4.52	640	Economy
6000	2200	23,2	65	195	50,5	(13,3)	165,6	149	3.24	533	Economy
	2000	22,5	55	165	42,6	(11,3)	156,1	141	3.84	598	Economy
	2000	19,3	45	135	36,5	(9,6)	145,4	131	4.46	647	Economy
8000	2350	21,5	65	195	52,0	(13,7)	169,0	147	3.14	525	Economy
	2050	21,4	55	165	43,0	(11,4)	159,3	139	3.78	598	Economy
	2000	18,8	45	135	36,5	(9,6)	148,4	130	4.44	655	Economy
10000	2150	19,9	55	165	43,7	(11,5)	162,5	138	3.70	595	Economy
	2000	18,4	45	135	36,5	(9,6)	151,4	129	4.41	663	Economy
12000	2300	18,3	55	165	45,2	(11,9)	165,9	136	3.56	583	Economy
	2000	17,9	45	135	36,5	(9,6)	154,5	127	4.37	681	Economy
14000	2075	17,7	45	135	37,1	(9,8)	157,8	122	4.27	664	Economy

NOTE

① For temperatures above/ below Standard (ISA), increase/decrease Range 1,7% and Endurance 1,1% for each 10°C above/below Standard Day Temperature for particular altitude.

② **Leaning with exhaust gas temperature (EGT) gage**

For the adjustment "**Best Power**", first lean the mixture to achieve the top exhaust temperature (peak EGT) and then enrich again until the exhaust temperature is 100°F lower than peak EGT.

For the adjustment "**Best Economy**", simply lean the mixture to achieve the top exhaust temperature (peak EGT).

Leaning without exhaust gas temperature (EGT) gage and flowmeter

Slowly move mixture control from "Full rich" position towards lean position. Continue leaning until slight loss of power is noted (Loss of power may or may not be accompanied by rough engine run). Then enrich until engine runs smoothly and power is regained.

CAUTION

Always return the mixture to full rich before increasing power settings.

906.6 WEIGHT AND BALANCE

LOADING WEIGHTS AND MOMENTS

TOTAL FUEL CAPACITY: 205 LITER (54,1 US GAL.)

ACRO & CENTER TANK			FUEL	WING TANKS		
LITER (US GAL)	KG (LBS)	KG x CM (IN LBS)	LITER (US GAL)	KG (LBS)	KG x CM (IN x LBS)	
9 (2,4)	6,5 (14,3)	168 (146)	10 (2,6)	7,2 (15,9)	238 (207)	
20 (5,3)	14,4 (31,8)	531 (461)	20 (5,3)	14,4 (31,8)	475 (412)	
25 (6,6)	18,0 (39,7)	696 (604)	40 (10,6)	28,8 (63,5)	950 (825)	
30 (7,9)	21,6 (47,6)	861 (747)	60 (15,9)	43,2 (95,3)	1426 (1238)	
35 (9,2)	25,2 (55,6)	1026 (891)	80 (21,1)	57,6 (127,0)	1901 (1650)	
40 (10,6)	28,8 (63,5)	1191 (1034)	100 (26,4)	72,0 (158,8)	2376 (2063)	
45 (11,9)	32,4 (71,4)	1356 (1177)	120 (31,7)	86,4 (190,5)	2851 (2475)	
51 (13,5)	36,7 (80,9)	1554 (1349)	140 (36,9)	100,8 (222,2)	3326 (2888)	
			154 (40,6)	110,8 (244,4)	3656 (3177)	

906.7 DESCRIPTION OF THE SYSTEM

Wing tank:

The leading edge section of each wing in front of main spars forms an integral fuel tank providing two interconnected tanks with 154 litres (40,7 US GAL.) total capacity. Each side of the wing has a 2" diameter filler cap for gravity refuelling. The long range tank has two compartments in either wing which are separated by a slosh rib. Due to the interconnection the fuel level of the left and right integral tank will equalize during refuelling within reasonable time. For max. fuel capacity, the first filled side have to be filled once again! The wing tank can be completely emptied in flight.

906.8 HANDLING, SERVICING AND MAINTENANCE

Not affected.

Left blank intentionally

SECTION 907

AIRTOW HOOK

Table of Contents

<i>Paragraph</i>		<i>Page</i>
907.1	GENERAL	907-3
907.2	LIMITATIONS	907-3
907.3	EMERGENCY PROCEDURES	907-4
907.4	NORMAL PROCEDURES	907-4
907.5	PERFORMANCE	907-5
907.6	WEIGHT AND BALANCE	907-7
907.7	DESCRIPTION OF THE SYSTEM	907-7
907.8	HANDLING, SERVICING AND MAINTENANCE	907-7

Left blank intentionally

907 AIRTOW HOOK

907.1 GENERAL

The EXTRA 300/S can optionally be equipped with a "TOST" glider air-tow release Typ E 85. The release mechanism is mounted at the tail spring end and actuated from the cockpit by a yellow knob.

The following combinations are certified:

Aircraft

Engine: AEIO 540-L1B5 or AEIO 540-L1B5D

Propeller: MTV-14-B-C/C190-17

Exhaust system: Typ Gomolzig EA 300-606000 or standard exhaust PC-63104 with silencer: NSD GO3-606500

Air-tow release system according to replacement instruction: UA-300-4-95

Air-tow release: "TOST, E 85"

Glider

MTOW of the glider: 765Kg

Max. air towing speed of the glider: min. 152 Km/h

Air tow cable and breaking piece (weak links)

Length of the synthetic tow between 40 m and 60 m

Ultimate load of the air-tow max. 850 kp (1875 lbs)

If tows with higher ultimate load are used a breaking piece (weak links) of max. 850 kp (1875 lbs) needs to be interconnected.

907.2 LIMITATIONS

For a safe air towing the following points must be observed:

- 1.) MTWO of the aircraft: 820 kg (1808 lbs)
- 2.) Max. empty weight of the aircraft: 697 kg (1536 lbs)
- 3.) passenger: pilot only

CAUTION

- 4.) Min. air-towing speed: **66 KIAS**
- 5.) Best air-towing speed: **72 KIAS - 76 KIAS**

CAUTION

- 6.) Maximum air-towing speed = maximum permissible air-towing speed of the glider
- 7.) The maximum permissible cylinder head temperature is 500° F (red line).
- 8.) interior mirror mounted

For the location of the yellow release knob the following placard has to be attached in the near of the knob:

AIR TOW

907.3 EMERGENCY PROCEDURES

A) ABORTED TAKE OFF

- | | |
|------------------------|--------------------|
| 1. Pilot of the glider | INFORM |
| 2. Throttle | IDLE |
| 3. Mixture | IDLE CUT OF |
| 4. Brakes | APPLY AS PRACTICAL |

B) ENGINE FAILURE IMMEDIATELY AFTER TAKEOFF

Stall speed: 60 KIAS

- | | |
|------------------------|----------------------|
| 1. Pilot of the glider | INFORM |
| 2. Air tow | RELEASE |
| 3. Airspeed | 80 KIAS |
| 4. Mixture | IDLE CUT OFF |
| 5. Fuel shutoff valve | OFF |
| 6. Ignition switch | OFF |
| 7. Master switch | OFF |
| 8. Forced landing | PERFORM AS PRACTICAL |

C) EXCESSIVE "CLIMB OVER" BY THE TOWING GLIDER

- | | |
|------------------------|----------------------|
| 1. Pilot of the glider | INFORM |
| 2. Air tow | RELEASE |
| 3. Landing | PERFORM AS PRACTICAL |

D) TOW BREAK

- | | |
|------------------------|----------------------|
| 1. Pilot of the glider | INFORM |
| 2. Landing | PERFORM AS PRACTICAL |

907.4 NORMAL PROCEDURES

Preflight inspection, starting procedures, take-off procedure and the following climbing flight have to be carry out in accordance with Chapter 4 "Normal procedure". In addition to this procedures the following points have to be observed:

A) PRIOR TO THE TAKE OFF

A release test needs to be conducted to determine safe release operation. The test shall be made on both, aircraft and glider.

B) TAKE OFF

After air-tow hook up the tow shall be tightened gently. During the following take-off and climb the maximum air-tow speed of the glider must be observed.

C) CLIMB

While climbing the max C.H.T. must be observed. Towing light gliders, the intial climb angle may be very steep. Information of the glider pilot is recomended.

D) RELEASE

After the release of the glider a gently left handed descent shall be flow to avoid collision of glider and air-tow.

E) DESCENT AND LANDING

While descending the engine temperatures shall be observed (Avoid overcooling). Final approach should account for the air-tow hanging below the aircraft flight path.

907.5 PERFORMANCE

The existing POH-Data remain valid with the exception of:

TAKE-OFF DISTANCE (in Meter)

Conditions:

Power: over 2600 Rpm and full throttle, mixture rich,
short grass, dry and paved level runway, no wind,
takeoff weight of the towing aircraft: 820Kg (1808lbs)

Liftoff speed (T/O): 65 KIAS = 120 Km/h indicated

Obstacle clearance speed over 15m (50ft) : 70 KIAS = 130 Km/h indicated

For every 5 kts headwind, the takeoff (T/O) distance can be decreased by 5%.

For every 2kts tailwind (up to 10) kts, the (T/O) distance is increased by 10%.

CAUTION

Maximum permissible air-towing speed of the glider needs to be observed.

Takeoff weight glider: 350 Kg

Press.- altitude	-10°C OAT		0°C		10°C		20°C		30°C		40°C	
	T/O	50 ft	T/O	50 ft	T/O	50 ft	T/O	50 ft	T/O	50 ft	T/O	50 ft
0 ft	134	219	150	244	166	271	184	300	202	331	223	364
2000 ft	156	256	174	285	194	316	214	350	236	386	260	424
4000 ft	183	299	204	333	226	370	251	409	276	451	304	497
6000 ft	214	350	239	390	265	434	294	480	324	530	357	583
8000 ft	252	411	281	459	312	510	346	565	382	624	421	687

Takeoff weight glider: 600 Kg

Press.- altitude	-10°C OAT		0°C		10°C		20°C		30°C		40°C	
	T/O	50 ft	T/O	50 ft	T/O	50 ft	T/O	50 ft	T/O	50 ft	T/O	50 ft
0 ft	176	287	196	320	217	355	240	393	265	433	291	476
2000 ft	205	334	228	373	253	414	280	458	309	505	340	555
4000 ft	239	391	267	436	296	484	328	535	362	591	398	650
6000 ft	280	458	313	511	347	567	385	628	425	693	467	763
8000 ft	329	538	368	600	409	668	453	740	500	817	550	899

Takeoff weight glider: 765 Kg

Press.- altitude	-10°C OAT		0°C		10°C		20°C		30°C		40°C	
	T/O	50 ft	T/O	50 ft	T/O	50 ft	T/O	50 ft	T/O	50 ft	T/O	50 ft
0 ft	220	360	245	401	272	445	301	492	332	542	365	596
2000 ft	257	419	286	467	317	518	351	574	387	633	426	696
4000 ft	300	489	334	546	371	606	411	671	453	740	499	814
6000 ft	351	574	392	640	435	711	482	787	532	869	585	956
8000 ft	413	674	461	752	512	836	567	926	626	1023	690	1126

CLIMBRATE

Conditions:

Power: 2500 Rpm and full throttle, mixture rich,

Speed of the aircraft tow: 76 KIAS = 140 Km/h,

Weight of the towing aircraft: m = 820 Kg (1808 lb), (1 Pilot = 86 kg, Acro & Center Tank full 38 L, Wingtank 30 L)

Tow force: glider with m = 350 Kg

Pressure altitude	0°C OAT		10°C		20°C		30°C	
	ft/min	m/s	ft/min	m/s	ft/min	m/s	ft/min	m/s
0 ft	1610	8,2	1540	7,8	1480	7,5	1410	7,2
1000 ft	1540	7,8	1475	7,5	1410	7,2	1345	6,8
2000 ft	1475	7,5	1400	7,1	1340	6,8	1275	6,5
3000 ft	1400	7,1	1335	6,8	1270	6,4	1210	6,1
4000 ft	1330	6,8	1265	6,4	1200	6,1	1140	5,8
5000 ft	1260	6,4	1195	6,1	1130	5,7	1070	5,4
6000 ft	1190	6,0	1130	5,7	1065	5,4	1000	5,1
7000 ft	1120	5,7	1060	5,4	995	5,1	935	4,7
8000 ft	1050	5,3	990	5,0	925	4,7	865	4,4

Tow force: glider with m = 600 Kg

Pressure altitude	0°C OAT		10°C		20°C		30°C	
	ft/min	m/s	ft/min	m/s	ft/min	m/s	ft/min	m/s
0 ft	1280	6,5	1210	6,1	1150	5,8	1080	5,5
1000 ft	1210	6,1	1145	5,8	1080	5,5	1015	5,2
2000 ft	1140	5,8	1080	5,5	1010	5,1	950	4,8
3000 ft	1080	5,5	1005	5,1	940	4,8	880	4,5
4000 ft	1005	5,1	935	4,7	870	4,4	810	4,1
5000 ft	935	4,7	870	4,4	800	4,1	740	3,8
6000 ft	865	4,4	800	4,1	735	3,7	675	3,4
7000 ft	800	4,1	730	3,7	670	3,4	605	3,1
8000 ft	730	3,7	670	3,4	600	3,0	545	2,8

Tow force: glider with m = 765 Kg

Pressure altitude	0°C OAT		10°C		20°C		30°C	
	ft/min	m/s	ft/min	m/s	ft/min	m/s	ft/min	m/s
0 ft	920	4,7	850	4,3	785	4,0	725	3,7
1000 ft	850	4,3	780	4,0	720	3,7	655	3,3
2000 ft	780	4,0	715	3,6	650	3,3	585	3,0
3000 ft	710	3,6	645	3,3	580	2,9	515	2,6
4000 ft	645	3,3	575	2,9	510	2,6	450	2,3
5000 ft	575	2,9	505	2,6	445	2,3	380	1,9
6000 ft	505	2,6	440	2,2	375	1,9	310	1,6
7000 ft	435	2,2	370	1,9	305	1,5	240	1,2
8000 ft	365	1,9	300	1,5	235	1,2	180	0,9

907.6 WEIGHT AND BALANCE

Not affected.

907.7 DESCRIPTION OF THE SYSTEM

The release mechanism is a typ "E 85" of the "TOST" company, Munich. It is mounted at the tail spring rear end aft the tail wheel and activated with a yellow handle located at the rear seat cockpit via a bowden cable.

907.8 HANDLING, SERVICING AND MAINTENANCE

Service and maintenance needs to be conducted in accordance with the latest operation handbook (Typ E 85) of the manufacturer TOST GmbH, Germany. Additionally during the 100 h inspection the bowden cable and the release handle have to be checked.

Left blank intentionally

SECTION 908

SMOKE SYSTEM

Table of Contents

<i>Paragraph</i>		<i>Page</i>
908.1	GENERAL	908-3
908.2	LIMITATIONS	908-3
908.3	EMERGENCY PROCEDURES	908-4
908.4	NORMAL PROCEDURES	908-4
908.5	PERFORMANCE	908-5
908.6	WEIGHT AND BALANCE	908-5
908.7	DESCRIPTION OF THE SYSTEM	908-6
908.8	HANDLING, SERVICING AND MAINTENANCE	908-7

Left blank intentionally

908 SMOKE SYSTEM

908.1 GENERAL

For performing at airshows, the EXTRA 300 S may optionally be equipped with a smoke system.

908.2 LIMITATIONS

For safe operation of the smoke system the following limitations have to be considered:

- 1) Max. takeoff weight "**MTOW**": 820 kg
- 2) **Specification** of the smoke oil: Straight paraffin oil, viscosity 30-50cts at 20°C (68°F), initial boiling point >330°C (626°F)
For example: *Fauth FC05*, *Texaco Canopus 13* or equivalent
- 3) Local **airfield** and **weather conditions** have to be considered:
For the prevention of a fire alarm, inform the flight control before you activate the smoke system
- 4) Recommended **Manifold pressure**: min. 20" Hg
- 5) The activation of the smoke system **on ground is only allowable for a brief system test.**
- 6) The operation of the smoke system is **not allowable** for the standard exhaust (6 into 2) PC-63104 **with** mounted, external silencer NSD GO3-606500.
- 7) Wearing a parachute is strongly recommended

Operating Markings & Placards:

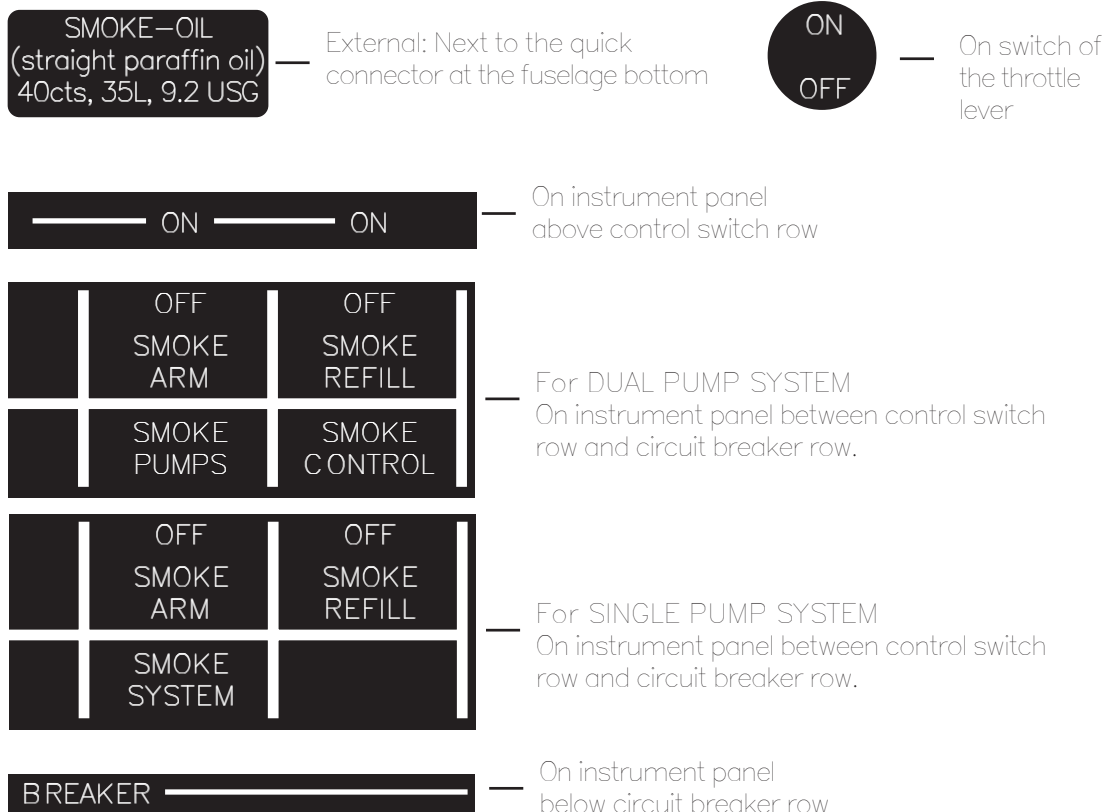

908.3 EMERGENCY PROCEDURES

FAILURE OF THE SMOKE-SYSTEM

- 1. Switch "SMOKE ARM" and "SMOKE REFILL": OFF
- 2. Circuit breaker PULL

FIRE IN FLIGHT

- 1. Switch "SMOKE ARM" OFF

CAUTION

If the fire (after the smoke system is shut off) will not extinguish proceed as follows:

- 2. Mixture IDLE CUT OFF
- 3. Fuel selector valve OFF (Pull & Turn)
- 4. Master switch OFF
- 5. Airspeed 100 KIAS, find your airspeed/attitude that will keep the fire away from the cockpit
- 6. Land AS SOON AS POSSIBLE
- 7. If fire persists or aircraft is uncontrollable and wearing a parachute BAIL OUT

SMOKE IN THE COCKPIT

- 1. Switch "SMOKE ARM" OFF
- 2. Bad weather window OPEN
- 3. Ventilation OPEN
- 4. If smoke persists in the cockpit, land AS SOON AS PRACTICAL

908.4 NORMAL PROCEDURES

The smoke system includes features for refilling the smoke oil tank and smoke generation:

A) REFILL

A separate refill hose is delivered with the smoke system which has to be used for filling the smoke oil tank from the paraffin oil supply canister or barrel.

- 1. Refill hose CONNECT hose nipple to quick connector at the fuselage bottom; IMMERSE the other end into the paraffin oil in the canister/barrel
- 2. Switch "SMOKE REFILL" ON

NOTE

The refilling should start within max. 30 sec. If this is not the case, the refill lines, fittings and filter (if installed) have to be checked for soiling or leaks. Refilling procedure can be supported by reducing the suction height e.g. lifting the canister. The fully filled status is sensed by the floating device which automatically switches the refilling off.

After automatic refill shut-off :

- | | |
|--------------------------|------------|
| 3. Switch "SMOKE REFILL" | OFF |
| 4. Refill hose | DISCONNECT |

CAUTION

A shut-off failure of the refill process can be recognized by smoke oil spilling out of the vent line. In this case, turn off refill switch. The floating device switch in the smoke oil tank has to be checked accordingly.

B) SMOKE GENERATION

- | | |
|---|----------------|
| 1. Bad weather window and ventilation | CLOSE |
| 2. "SMOKE ARM" Switch | ON |
| 3. Manifold Pressure | minimum 20" Hg |
| 4. Switch in the throttle lever
for smoke generation | ON - OFF |

NOTE

It is recommended to operate the smoke system only in forward flight, because during reverse maneuvers (for example tail slide) smoke might enter the cockpit via the air vents.

908.5 PERFORMANCE

Not affected.

908.6 WEIGHT AND BALANCE

Capacity		Mass		Moment	
Litre	US gal	Kg	lbs	Kgcm	in-lbs
5	1.3	4.3	9.4	74	64
10	2.7	8.5	18.7	148	128
15	4	12.8	28.1	223	192
20	5.3	17	37.5	294	255
25	6.6	21.3	46.9	368	320
30	8	25.6	56.2	443	384
35	9.3	29.7	65.6	513	448

Specific Weight of the paraffin oil = 0.85 kg/Litre

NOTE

The smoke system does not feature a capacity dipstick. In the case of unknown filling, the smoke oil tank should be drained and refilled with a known quantity. If this is not possible, the most adverse case has to be taken for CG calculation. (This may be either completely full or completely empty tank).

908.7 DESCRIPTION OF THE SYSTEM

On pilot's demand the smoke system produces a trail of smoke by injection of smoke oil (straight paraffin oil) into the engine exhaust. The smoke oil is vaporised by the exhaust gas heat and is visible as dense smoke after leaving the exhaust.

For smoke system activation the "SMOKE ARM" switch located at the pilot instrument panel needs to be switched ON first. The smoke „ON-OFF“ toggle switch is located on top of the throttle lever. For filling the smoke oil tank the "SMOKE REFILL" switch needs to be ON. After the refill process is completed the "SMOKE REFILL" has to be switched OFF. When both switches ("SMOKE ARM" and "SMOKE REFILL") are in the ON position, the smoke system is not energized and will not run. There are two different systems approved:

A) DUAL PUMP SYSTEM

The smoke oil tank is filled by a refill pump through a quick connector located in the aircraft belly fairing. A filled smoke oil tank is detected by a float switch placed in the tank which shuts the refill pump off. An additional injection pump placed at the firewall within the engine compartment pumps the smoke oil from the smoke oil tank through a solenoid valve and the injector nozzle into the hot exhaust gas to generate smoke.

The system consists of:

- Floptube smoke oil tank with float switch
- Refill pump in the pilot compartment with quick connector in the belly fairing
- Injection pump in the engine compartment with a shut-off solenoid in the pilot compartment
- "ON-OFF" switch on the throttle lever
- Two relays (make contact type) for pumps and for the solenoid control
- "SMOKE ARM" switch to arm the system and "SMOKE REFILL" switch for refilling placed at the instrument-panel
- Circuit breaker for pumps and control placed at the instrument-panel

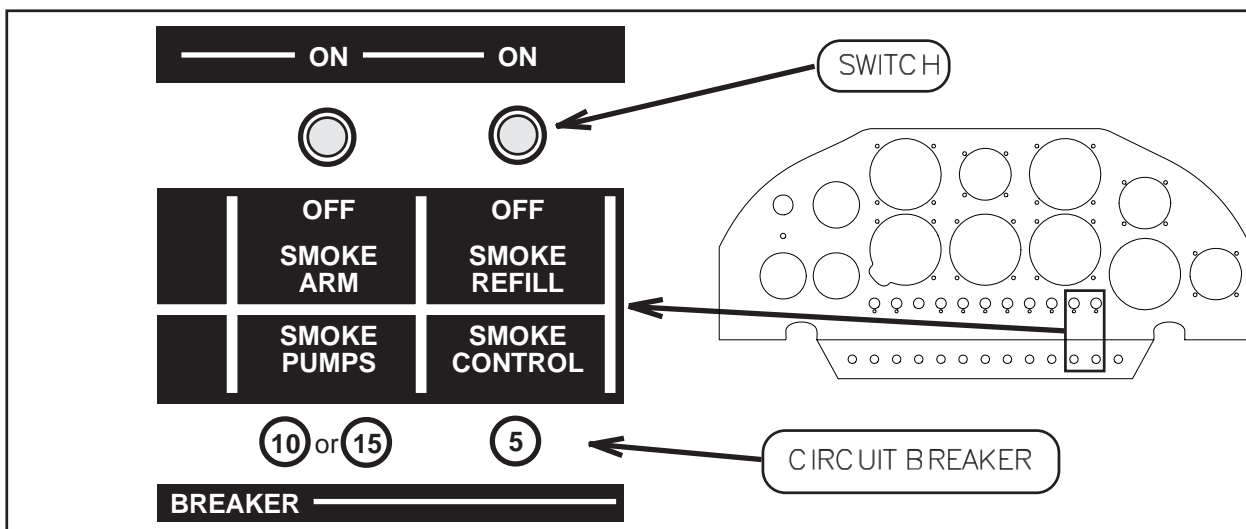

B) SINGLE PUMP SYSTEM

The smoke oil tank is filled by a pump (reversed polarity) through a quick connector located in the aircraft belly fairing. This line includes a filter to prevent dirt to enter the smoke system. A filled smoke oil tank is detected by a float switch placed in the tank which shuts the pump off. The same pump (normal polarity) injects the smoke oil from the smoke oil tank through an overpressure/check valve and the injector nozzle into the hot exhaust gas to generate smoke.

The system consists of:

- Floptube smoke oil tank with float switch
- Refill/Injection pump in the pilot compartment with quick connector in the belly fairing
- Overpressure/check valve in smoke oil supply line to the nozzle
- Filter element in the refill line
- "ON-OFF" switch on the throttle lever
- Two relays (changeover contact type) for pump control
- "SMOKE ARM" switch to arm the system and "SMOKE REFILL" switch for refilling placed at the instrument-panel
- Only 1 circuit breaker for pump and control placed at the instrument-panel

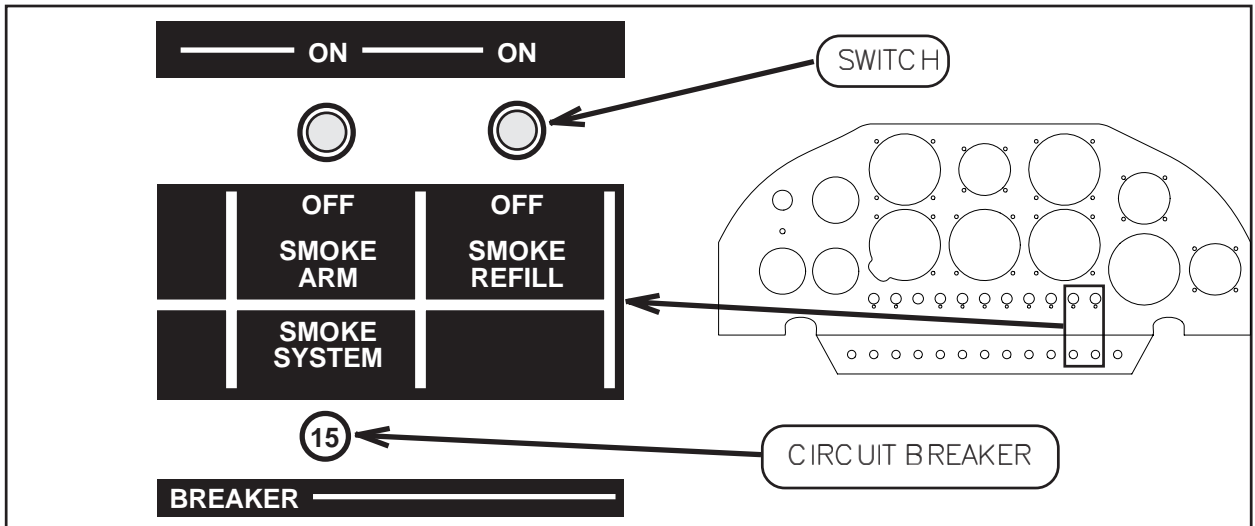

908.8 HANDLING, SERVICING AND MAINTENANCE

At every refilling:

- Check automatic shut-off

Additionally during the 100h Check for the DUAL PUMP SYSTEM

- Check the system for leakage (lines, fittings, tank)
- Check the smoke oil tank for proper attachment
- Check the function of the solenoid valve
- Clean the injector nozzle: if required, remove carbon debris

Additionally during the 100h Check for the SINGLE PUMP SYSTEM

- Check the system for leakage (lines, fittings, tank)
- Check the smoke oil tank for proper attachment
- Clean the overpressure/check valve: if required, remove oil residue
- Clean the injector nozzle: if required, remove carbon debris
- Clean the filter element

After each flight with activated Smoke System

- Clean the aircraft belly fairing and the rudder cable from oil slick

NOTE

The rudder cables might suffer from increased wear, when they are covered with smoke oil and dust.

Left blank intentionally

SECTION 912

FILSER TRT 600 TRANSPONDER

Table of Contents

<i>Paragraph</i>		<i>Page</i>
912.1	GENERAL	912-3
912.1.1	Front Panel Operation	912-3
912.1.2	System Operation	912-5
912.1.3	Error Reporting / Fault Codes	912-7
912.2	LIMITATIONS	912-8
912.3	EMERGENCY PROCEDURES	912-8
912.4	NORMAL PROCEDURES	912-8
912.5	PERFORMANCE	912-8

Left blank intentionally

912.1 GENERAL

The TRT 600 is Level 2es Class2 (SSR Mode S Elementary Surveillance) Transponder. It has Mode A, Mode A/C and Mode S capability. In Mode S the transponder provides acquisition capability. Furthermore, the TRT 600 has a built-in barometric pressure altitude coder in 100 ft increments.

NOTE

Refer to latest edition of Filser TRT 600 Pilot's Operation Manual (Doc. No. 03.200.010.11) to get familiar with the TRT 600 Transponder.

The following illustration of the front panel of the TRT 600 will assist the operator to understand this Mode S Transponder.

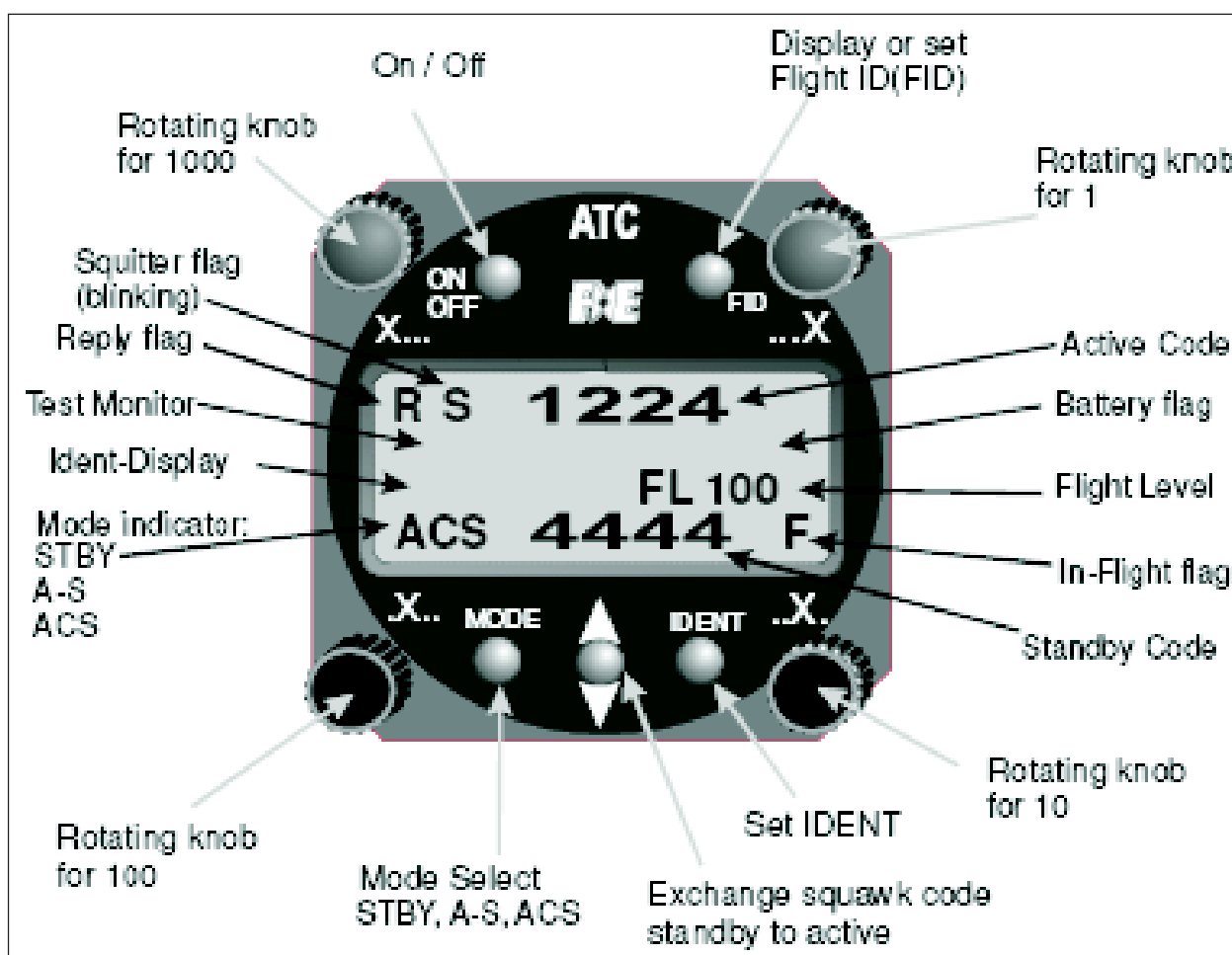

912.1.1 FRONT PANEL OPERATION

The input elements consist of four rotating knobs and five push buttons.

ROTATING KNOBS

Four rotating knobs are used to select the IDENT CODE.

The assignments **X... , .X.. , ..X. , ...X** indicate the position of the code number set by each knob.

PUSH BUTTONS

ON OFF

The unit can be turned on by pressing the **ON OFF** button for less than 1 second.
The unit can be turned off by pressing the **ON OFF** button for more than 2 seconds.
(also refer to the System Operation Paragraph 912.1.2).

MODE

The following modes can be selected in sequence by pressing the **MODE** button:

STBY Standby Mode used for aircraft on ground with reduced squitter rate, only Mode S with altitude reporting all ZERO only

A-S Mode A active with Mode C frames only and Mode S with altitude reporting all ZERO only

ACS Mode A ,C and S full active

ARROWS UP AND DOWN

To activate the inserted SQUAWK CODE from the lower standby line to the upper active position the button with the **UP AND DOWN ARROWS** shall be pressed.

IDENT

The **IDENT** push button causes the special position identification pulse (SPI) to be transmitted for a period of 18 seconds.

FID

In the Standby Mode, the Aircraft Identification (Flight Identification) and Aircraft Address can be checked by pressing the push button **FID**. The Flight Identification is displayed on the right side of the lower line. By pressing the button **FID** for more than 3 seconds the input mode can be set or the Flight Identification can be changed.

FLAGS

Squitter Flag

When the extended squitter is active the letter **'S'** is displayed on the left top side of the display. As the squitter is a periodic signal, the displayed **'S'** is blinking.

Reply Flag

In case of the transponder replying to interrogations the letter **'R'** is displayed on the left top side of the display.

In-Flight Flag

When there is an undercarriage switch installed, the display can toggle between the letters '**F**' whether the aircraft is in flight condition or the letter '**G**' whether the aircraft is in „on-ground“ condition. The flag is displayed on the right bottom side of the display.

Battery Flag

If the power supply to the transponder drops below 10 Volts, the flag '**BAT**' appears and starts flashing.

912.1.2 SYSTEM OPERATION

The transponder should be turned off before starting and shutting down aircraft engines.

ON /OFF

After having switched on the **AVIONIC MASTER** switch the TRT 800 has to be turned on by hand by pressing the **ON OFF** button for less than 1 second. The display will first show the transponder type and the software and firmware version. To turn off the unit the button **ON/OFF** must be pressed for more than two seconds or the **AVIONIC MASTER** switch must be placed to the **OFF**-position. ACS is the default operation mode and the transponder replies to Mode A,C and S interrogations. The pressure altitude will be displayed as Flight Level.

SQUAWK SELECTION

Squawk selection is done with the four rotating knobs to provide 4096 identification codes. The assignments of the knobs, starting at top left, are:

- X...** selection of thousands (0-7)
- .X...** selection of hundreds (0-7)
- ..X.** selection of ten (0-7)
- ...X** selection of one (0-7)

The code is entered in the lower line and remains inactive. By pushing the **UP AND DOWN ARROWS** button the squawk code is transferred to the upper line and becomes active. The code in the upper line is always the active one.

IMPORTANT CODES:

- 1200 The VFR code for any altitude in the US (Refer to ICAO standards elsewhere)
- 7000 The VFR code commonly used in Europe (Refer to ICAO standards)
- 0021 The VFR code commonly used in Germany (default is set to 0021 at time of installation)
- 7500 Hijack code (Aircraft is subject to unlawful interference)
- 7600 Loss of communications
- 7700 Emergency

7777 Military interceptor operations (Never squawk this code)

0000 Military use (Not enterable)

Care should be taken not to select the code 7500 and all codes in the 7600-7777 range, which trigger special indicators in automated facilities. Only the code 7500 will be decoded as the hijack code. An aircraft's transponder code (if available) is utilized to enhance the tracking capabilities of the ATC facility, therefore care should be taken when making routine code changes.

STANDBY MODE

The standby mode is activated by pressing the **MODE** button once. This sets **'STBY'** in the mode indicator field. The transponder will now only reply to direct addressed Mode S interrogations. The squitter stays active at a lower rate.

ALTITUDE OFF

Switching off altitude reporting will be necessary if the ATC controller requests it. For switching off altitude reporting the **MODE** button has to be pressed until **'A-S'** is displayed. The altitude display shows **'FL —'** to indicate that the altitude reporting is not active. Now the transponder will reply on Mode C interrogations with Mode C frames only and Mode S interrogations with FL000 (= 0000ft) instead of the actual altitude.

IDENT

Pressing the **IDT** push button causes the special position identification pulse (SPI) to be appended to the Mode A replies for a period of 18 seconds and sets **'IDT'** in the display.

LOW POWER SUPPLY

If the power supply to the transponder drops below 10 Volts, the flag **'BAT'** appears and starts flashing.

DISPLAYING AIRCRAFT ADDRESS AND FLIGHT IDENTIFICATION

By pressing, the **FID** button for less than 3 seconds, while the unit is in Standby-mode, the left side of the bottom line will show the aircraft address.

NOTE

Only an authorized service station is allowed to enter or change the ICAO aircraft address. If you do not have the ICAO aircraft address. Please refer to your national aviation authority to apply for your aircraft address.

The Aircraft Identification (FID) code is displayed on the right bottom line and consists of seven alphanumerical characters.

CAUTION

The ICAO Flight Plan specifies only 7 characters as Flight Identification. Filser reserves 8 characters as stated in ED- 73B for further expansion of the flight plan. The user shall only program 7 characters for FID.

SELECTING FLIGHT IDENTIFICATION

By pressing the button **FID** for more than 3 seconds, the unit will change into the Flight Identification input menu. This FID code is a changeable alphanumerical flight number. The right lower knob is used to set the cursor position (flashing ^) and with the left lower knob the figures A..Z, blank, and 0..9 can be selected. To enter the code, press the **MODE** button or the **FID** button again. The FID code is stored in the external aircraft connector.

- a. Factory setting for the FID is '**ZZZZZZZ**'
- b. The authorized service station should program a default FID that can be the tail-number of the aircraft.
- c. The pilot has to change the FID manually if necessary.

912.1.3 ERROR REPORTING / FAULT CODES

The transponder's reception, transmission, altitude and power supply are monitored periodically. This self-testing routine is permanently active in the background. If any error occurs due to an internal malfunction or from an external disturbance at the antenna, the transponder changes to the Standby mode and '**Error**' is displayed on the lowest line. Additionally the result of the internal analysis are displayed in the second line.

LIST OF POSSIBLE ERRORS:

1. '**ANT**' will appear if the antenna is defective (e.g. broken cable).
2. '**FLerr**' instead of the altitude appears on the display, if there is an error with the altimeter or if the aircraft is outside the altitude range(FL-010 to FL350). If the mode ACS was active before, it will change to mode A-S automatically.
3. '**DC**' for a faulty transmitter power supply
4. '**FPG**' for internal communication errors,
5. '**TRX**' will appear for transmitter error. In this case, the unit will change to '**STBY**' and will stop all transmission.

To meet ICAO specifications the TRT 600 uses an external memory inside the aircraft connector housing of the cable set, which is a part of the aircraft. Because this cable is installed permanent into the aircraft, a change of the transponder will not affect the aircraft address and the Flight ID. In the event there is a Cradle error, (empty memory or data error) **'OUT OF ORDER'** will be displayed. The first line shows which kind of error is present:

'Cradle OFF' displayed means no or defective data.

'Cradle Data' displayed means digital checksum error.

After a few seconds the display shows normal operating condition but with inhibited Mode S. The transponder will work with Mode A/C only. You will need to consult an authorized service station to enter the ICAO aircraft address (see TRT 600 Installation Manual). Please consult your airworthiness authority for national procedures.

NOTE

If no valid ICAO 24 bit aircraft address is programmed to the unit or if the memory is inoperative the transponder will inhibit the Mode S functions. In this case only Mode A/C function will be available.

912.2 LIMITATIONS

Not applicable

912.3 EMERGENCY PROCEDURES

The following emergency codes should be noted:

7500 Hijacking

7600 Loss of communication

7700 Emergency

912.4 NORMAL PROCEDURES

Not applicable

912.5 PERFORMANCE

Not applicable

SECTION 913

FILSER TRT 800 TRANSPONDER

Table of Contents

<i>Paragraph</i>		<i>Page</i>
913.1	GENERAL	913-3
913.1.1	Front Panel Operation	913-3
913.1.2	System Operation	913-5
913.1.3	Error Reporting / Fault Codes	913-7
913.2	LIMITATIONS	913-8
913.3	EMERGENCY PROCEDURES	913-8
913.4	NORMAL PROCEDURES	913-8
913.5	PERFORMANCE	913-8

Left blank intentionally

913.1 GENERAL

The TRT 800 is Level 2es Class2 (SSR Mode S Elementary and Enhanced Surveillance) Transponder. It has Mode A, Mode A/C and Mode S capability. In Mode S the transponder provides acquisition and extended squitter capability. Furthermore, the TRT 800 has a built-in barometric pressure altitude coder in 100 ft increments.

NOTE

Refer to latest edition of Filser TRT 800 Pilot's Operation Manual (Doc. No. 03.210.010.11) to get familiar with the TRT 800 Transponder.

The following illustration of the front panel of the TRT 800 will assist the operator to understand this Mode S Transponder.

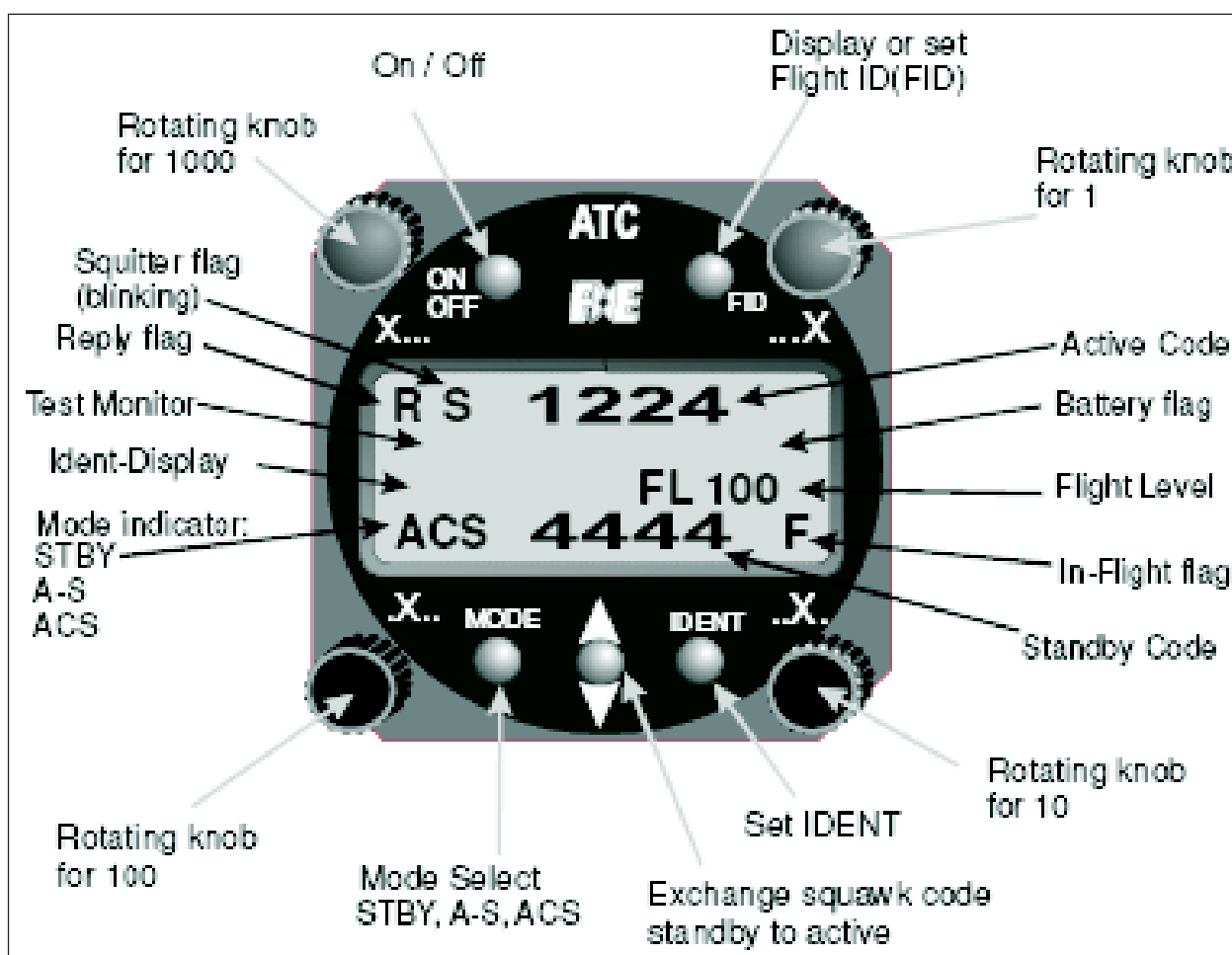

913.1.1 FRONT PANEL OPERATION

The input elements consist of four rotating knobs and five push buttons.

ROTATING KNOBS

Four rotating knobs are used to select the IDENT CODE.

The assignments **X... , .X.. , ..X. , ...X** indicate the position of the code number set by each knob.

PUSH BUTTONS

ON OFF

The unit can be turned on by pressing the **ON OFF** button for less than 1 second. The unit can be turned off by pressing the **ON OFF** button for more than 2 seconds. (also refer to the System Operation Paragraph 913.1.2)

MODE

The following modes can be selected in sequence by pressing the **MODE** button:

STBY Standby Mode used for aircraft on ground with reduced squitter rate, only Mode S with altitude reporting all ZERO only

A-S Mode A active with Mode C frames only and Mode S with altitude reporting all ZERO only

ACS Mode A ,C and S full active

ARROWS UP AND DOWN

To activate the inserted SQUAWK CODE from the lower standby line to the upper active position the button with the **UP AND DOWN ARROWS** shall be pressed.

IDENT

The **IDENT** push button causes the special position identification pulse (SPI) to be transmitted for a period of 18 seconds.

FID

In the Standby Mode, the Aircraft Identification (Flight Identification) and Aircraft Address can be checked by pressing the push button **FID**. The Flight Identification is displayed on the right side of the lower line. By pressing the button **FID** for more than 3 seconds the input mode can be set or the Flight Identification can be changed.

FLAGS

SQUITTER FLAG

When the extended squitter is active the letter **'S'** is displayed on the left top side of the display. As the squitter is a periodic signal, the displayed **'S'** is blinking.

REPLY FLAG

In case of the transponder replying to interrogations the letter **'R'** is displayed on the left top side of the display.

IN-FLIGHT FLAG

When there is an undercarriage switch installed, the display can toggle between the letters '**F**' whether the aircraft is in flight condition or the letter '**G**' whether the aircraft is in „on-ground“ condition. The flag is displayed on the right bottom side of the display.

BATTERY FLAG

If the power supply to the transponder drops below 10 Volts, the flag '**BAT**' appears and starts flashing.

913.1.2 SYSTEM OPERATION

The transponder should be turned off before starting and shutting down aircraft engines.

ON /OFF

After having switched on the **AVIONIC MASTER** switch the TRT 800 has to be turned on by hand by pressing the **ON OFF** button for less than 1 second. The display will first show the transponder type and the software and firmware version. To turn off the unit the button **ON/OFF** must be pressed for more than two seconds or the **AVIONIC MASTER** switch must be placed to the **OFF** position. ACS is the default operation mode and the transponder replies to Mode A,C and S interrogations. The pressure altitude will be displayed as Flight Level.

SQUAWK SELECTION

Squawk selection is done with the four rotating knobs to provide 4096 identification codes. The assignments of the knobs, starting at top left, are:

- X...** selection of thousands (0-7)
- .X...** selection of hundreds (0-7)
- ..X.** selection of ten (0-7)
- ...X** selection of one (0-7)

The code is entered in the lower line and remains inactive. By pushing the **UP AND DOWN ARROWS** button the squawk code is transferred to the upper line and becomes active. The code in the upper line is always the active one.

IMPORTANT CODES:

- 1200 The VFR code for any altitude in the US (Refer to ICAO standards elsewhere)
- 7000 The VFR code commonly used in Europe (Refer to ICAO standards)
- 0021 The VFR code commonly used in Germany (default is set to 0021 at time of installation)
- 7500 Hijack code (Aircraft is subject to unlawful interference)
- 7600 Loss of communications

7700 Emergency

7777 Military interceptor operations (Never squawk this code)

0000 Military use (Not enterable)

Care should be taken not to select the code 7500 and all codes in the 7600-7777 range, which trigger special indicators in automated facilities. Only the code 7500 will be decoded as the hijack code. An aircraft's transponder code (if available) is utilized to enhance the tracking capabilities of the ATC facility, therefore care should be taken when making routine code changes.

STANDBY MODE

The standby mode is activated by pressing the MODE button once. This sets **'STBY'** in the mode indicator field. The transponder will now only reply to direct addressed Mode S interrogations. The squitter stays active at a lower rate.

ALTITUDE OFF

Switching off altitude reporting will be necessary if the ATC controller requests it. For switching off altitude reporting the **MODE** button has to be pressed until **'A-S'** is displayed. The altitude display shows **'FL —'** to indicate that the altitude reporting is not active. Now the transponder will reply on Mode C interrogations with Mode C frames only and Mode S interrogations with FL000 (= 0000ft) instead of the actual altitude.

IDENT

Pressing the **IDT** push button causes the special position identification pulse (SPI) to be appended to the Mode A replies for a period of 18 seconds and sets **'IDT'** in the display.

LOW POWER SUPPLY

If the power supply to the transponder drops below 10 Volts, the flag **'BAT'** appears and starts flashing.

DISPLAYING AIRCRAFT ADDRESS AND FLIGHT IDENTIFICATION

By pressing, the **FID** button for less than 3 seconds, while the unit is in Standby-Mode, the left side of the bottom line will show the aircraft address.

NOTE

Only an authorized service station is allowed to enter or change the ICAO aircraft address. If you do not have the ICAO aircraft address. Please refer to your national aviation authority to apply for your aircraft address.

The Aircraft Identification (FID) code is displayed on the right bottom line and consists of seven alphanumerical characters.

CAUTION

The ICAO Flight Plan specifies only 7 characters as Flight Identification. Filser reserves 8 characters as stated in ED- 73B for further expansion of the flight plan. The user shall only program 7 characters for FID.

SELECTING FLIGHT IDENTIFICATION

By pressing the button **FID** for more than 3 seconds, the unit will change into the Flight Identification input menu. This FID code is a changeable alphanumerical flight number. The right lower knob is used to set the cursor position (flashing ^) and with the left lower knob the figures A..Z, blank, and 0..9 can be selected. To enter the code, press the **MODE** button or the **FID** button again. The FID code is stored in the external aircraft connector.

- a. Factory setting for the FID is '**ZZZZZZZ**'
- b. The authorized service station should program a default FID that can be the tail-number of the aircraft.
- c. The pilot has to change the FID manually if necessary.

913.1.3 ERROR REPORTING / FAULT CODES

The transponder's reception, transmission, altitude and power supply are monitored periodically. This self-testing routine is permanently active in the background. If any error occurs due to an internal malfunction or from an external disturbance at the antenna, the transponder changes to the Standby Mode and „**Error**“ is displayed on the lowest line. Additionally the result of the internal analysis are displayed in the second line.

LIST OF POSSIBLE ERRORS:

1. '**ANT**' will appear if the antenna is defective (e.g. broken cable).
2. '**FLerr**' instead of the altitude appears on the display, if there is an error with the altimeter or if the aircraft is outside the altitude range(FL-010 to FL350). If the mode ACS was active before, it will change to mode A-S automatically.
3. '**DC**' for a faulty transmitter power supply
4. '**FPG**' for internal communication errors,
5. '**TRX**' will appear for transmitter error. In this case, the unit will change to '**STBY**' and will stop all transmission.

To meet ICAO specifications the TRT 800 uses an external memory inside the aircraft connector housing of the cable set, which is a part of the aircraft. Because this cable is installed permanent into the aircraft, a change of the transponder will not affect the aircraft address and the Flight ID. In the event there is a Cradle error, (empty memory or data error) „OUT OF ORDER“ will be displayed. The first line shows which kind of error is present:

'Cradle OFF' displayed means no or defective data.

'Cradle Data' displayed means digital checksum error.

After a few seconds the display shows normal operating condition but with inhibited Mode S. The transponder will work with Mode A/C only. You will need to consult an authorized service station to enter the ICAO aircraft address (see TRT800 Installation Manual). Please consult your airworthiness authority for national procedures.

NOTE

If no valid ICAO 24 bit aircraft address is programmed to the unit or if the memory is inoperative the transponder will inhibit the Mode S functions. In this case only Mode A/C function will be available.

913.2 LIMITATIONS

Not applicable.

913.3 EMERGENCY PROCEDURES

The following emergency codes should be noted:

7500 Hijacking

7600 Loss of communication

7700 Emergency

913.4 NORMAL PROCEDURES

Not applicable.

913.5 PERFORMANCE

Not applicable.

SECTION 914

GARMIN GTX 327 TRANSPONDER

Table of Contents

<i>Paragraph</i>		<i>Page</i>
914.1	GENERAL	914-3
914.1.1	Mode Selection Keys	914-3
914.1.2	Code Selection	914-4
914.1.3	Keys for other GTX 327 Functions	914-4
914.2	LIMITATIONS	914-5
914.3	EMERGENCY PROCEDURES	914-6
914.3.1	Important Codes	914-6
914.4	NORMAL PROCEDURES	914-6
914.5	PERFORMANCE	914-6

Left blank intentionally

914.1 GENERAL

The GARMIN GTX 327 is a panel-mounted TSO.d transponder with the addition of timing functions. The transponder is a radio transmitter and receiver that operates on radar frequencies, receiving ground radar interrogations at 1030 MHz and transmitting a coded response of pulses to ground-based radar on a frequency of 1090 MHz.



NOTE

The GTX 327 owner accepts all responsibility for obtaining the proper license before using the transponder.

The coverage you can expect from the GTX 327 is limited to „line of sight“. Low altitude or aircraft antenna shielding by the aircraft itself may result in reduced range. Range can be improved by climbing to a higher altitude. It may be possible to minimize antenna shielding by locating the antenna where dead spots are only noticed during abnormal flight attitudes.

CAUTION

The GTX 327 should be turned off before starting or shutting down aircraft engine.

The GTX 327 Transponder is powered on by pressing the **STBY**, **ALT** or **ON** keys, or by the **AVIONIC MASTER** switch. After power on a start-up page will be displayed while the unit performs a self test.

914.1.1 MODE SELECTION KEYS

OFF

Powers off the GTX 327.

STBY

Powers on the transponder in standby mode. At power on the last active identification code will be selected. When in standby mode, the transponder will not reply to any interrogations.

ON

Powers on the transponder in Mode A. At power on the last active identification code will be selected. In this mode the transponder replies to interrogations, as indicated by the Reply Symbol. Replies do not include altitude information.

ALT

Powers on the transponder in Mode A and Mode C. At power on the last active identification code will be selected. In ALT mode, the transponder replies to identification and altitude interrogations, as indicated by the Reply Symbol. Replies to altitude interrogations include standard pressure altitude received from a separate encoder.

914.1.2 CODE SELECTION

Code selection is done with eight keys (**0 - 7**) that provide 4,096 active identification codes. Pushing one of these keys begins the code selection sequence. The new code will not be activated until the fourth digit is entered. Pressing the **CLR** key will move the cursor back to the previous digit. Pressing the **CLR** key when the cursor is on the first key of the code, or pressing the **CRSR** key during code entry, will remove the cursor and cancel data entry, restoring the previous code. The numbers **8** and **9** are not used for code entry, only for entering a Count Down time, and in Configuration Mode.

IMPORTANT CODES:

1200 The VFR code for any altitude in the US (Refer to ICAO standards elsewhere)

7000 The VFR code commonly used in Europe (Refer to ICAO standards)

0021 The VFR code commonly used in Germany (default is set to 0021 at time of installation)

7500 Hijack code (Aircraft is subject to unlawful interference)

7600 Loss of communications

7700 Emergency

7777 Military interceptor operations (Never squawk this code)

0000 Military use (Not enterable)

Care should be taken not to select the code 7500 and all codes in the 7600-7777 range, which trigger special indicators in automated facilities. Only the code 7500 will be decoded as the hijack code. An aircraft's transponder code (if available) is utilized to enhance the tracking capabilities of the ATC facility, therefore care should be taken when making routine code changes.

914.1.3 KEYS FOR OTHER GTX 327 FUNCTIONS

IDENT

Pressing the **IDENT** key activates the Special Position Identification (SPI) Pulse for 18 seconds, identifying your transponder return from others on the air traffic controller's screen. The word '**IDENT**' will appear in the upper left corner of the display while the IDENT mode is active.

VFR

Sets the transponder code to the pre-programmed VFR code selected in the Configuration Mode. Pressing the **VFR** key again will restore the previous identification code.

START/STOP

Starts and stops the Count Up and Count Down timers.

CRSR

Initiates entry of starting time for the Count Down timer and cancels transponder code entry.

CLR

Resets the Count Up and Count Down timers and cancels the previous keypress during code selection.

8

Reduces Contrast and Display Brightness when the respective pages are displayed. Also enters the number eight into the Count Down timer.

9

Increases Contrast and Display Brightness when the respective pages are displayed. Also enters the number nine into the Count Down timer.

FUNC

Changes the page shown on the right side of the display. Displayed data includes Pressure Altitude, Flight Time, Count Up timer, Count Down timer, and may include Contrast and Display Brightness, depending on configuration (refer to the screen description below):

SCREEN DESCRIPTION:

'PRESSURE ALT'

Displays the altitude data supplied to GTX 327 in feet, hundreds of feet (i.e., flight level), or meters, depending on configuration.

'FLIGHT TIME'

Displays the Flight Time, which is controlled by the **START/STOP** key.

'COUNT UP TIMER'

Controlled by the **START/STOP** and **CLR** keys.

'COUNT DOWN TIMER'

Controlled by **START/STOP**, **CLR**, and **CRSR** keys. The initial Count Down time is entered with the **0 - 9** keys.

'CONTRAST'

This page is only displayed if manual contrast mode is selected in Configuration Mode. Contrast is controlled by the **8** and **9** keys.

'DISPLAY'

This page is only displayed if manual backlighting mode is selected on Configuration Mode. Backlighting is controlled by the **8** and **9** keys.

914.2 LIMITATIONS

Not applicable.

914.3 EMERGENCY PROCEDURES

914.3.1 IMPORTANT CODES

7600 Loss of communications.

7500 Hijacking.

7700 Emergency (All secondary surveillance radar sites are ready to receive this code at all times).

See the Airman's Information Manual (AIM) for a detailed explanation of identification codes.

914.4 NORMAL PROCEDURES

Not applicable.

914.5 PERFORMANCE

Not applicable.

SECTION 915

GARMIN GTX 330 TRANSPONDER

Table of Contents

<i>Paragraph</i>		<i>Page</i>
915.1	GENERAL	915-3
915.1.1	Mode Selection Keys	915-4
915.1.2	Code Selection	915-4
915.1.3	Keys for other GTX 330 Functions	915-5
915.1.4	Function Display	915-5
915.1.5	Configuration Mode	915-6
915.1.6	Altitude trend indicator	915-6
915.1.7	Failure Annunciation	915-6
915.2	LIMITATIONS	915-7
915.3	EMERGENCY PROCEDURES	915-7
915.3.1	Important Codes	915-7
915.4	NORMAL PROCEDURES	915-7
915.5	PERFORMANCE	915-7

Left blank intentionally

915.1 GENERAL

The Garmin GTX 330 panel mounted Mode S Transponder is a radio transmitter and receiver that fulfills the role of the airborne beacon equipment according to the requirements of the Air Traffic Radar Beacon System (ATCRBS). Its functionality includes replying to ATCRBS Mode A and C and Mode S interrogations. The Mode S function will allow the ground station to individually select the aircraft by its Aircraft Address assigned to the aircraft by the aviation agency.



It operates on radar frequencies, receiving ground radar interrogations at 1030 MHz and transmitting a coded response of pulses to ground-based radar on a frequency of 1090 MHz. The GTX 330 is equipped with IDENT capability that activates the Special Position Identification (SPI) pulse for 18 seconds. Mode S transmit/receive capability also requires 1090 MHz transmitting and 1030 MHz receiving for Mode S functions.

In addition to displaying the code, reply symbol and mode of operation, the GTX 330 screen will display pressure altitude and timer functions. The displayed pressure altitude may not agree with the aircraft's baro-corrected altitude under non standard conditions. The unit also features flight timers.

The Traffic Information Service (TIS) is not available in this installation.

NOTE

The GTX 330 owner accepts all responsibility for obtaining the proper license before using the transponder.

The coverage you can expect from the GTX 330 is limited to „line of sight“. Low altitude or aircraft antenna shielding by the aircraft itself may result in reduced range. Range can be improved by climbing to a higher altitude. It may be possible to minimize antenna shielding by locating the antenna where dead spots are only noticed during abnormal flight attitudes.

CAUTION

The GTX 330 should be turned off before starting or shutting down aircraft engine.

The GTX 330 Transponder is automatically powered on by the respective **AVIONIC MASTER** switch or when previously manually powered off while **AVIONIC MASTER** switch is on by pressing the **STBY**, **ALT** or **ON** keys. After power on, a start-up page will be displayed while the unit performs a self test.

915.1.1 MODE SELECTION KEYS

OFF

Powers off the GTX 330.

STBY

Selects the standby mode displaying the last active identification code. When in standby mode, the transponder will not reply to any interrogations.

ON

Selects Mode A. At power on the last active identification code will be selected. In this mode the transponder replies to interrogations, as indicated by the Reply Symbol. Replies do not include altitude information.

ALT

Powers on the transponder in Mode A and Mode C. At power on the last active identification code will be selected. In ALT mode, the transponder replies to identification and altitude interrogations, as indicated by the Reply Symbol. Replies to altitude interrogations include standard pressure altitude received from a separate encoder.

915.1.2 CODE SELECTION

Code selection is done with eight keys (**0 - 7**) that provide 4,096 active identification codes. Pushing one of these keys begins the code selection sequence. The new code will not be activated until the fourth digit is entered. Pressing the **CLR** key will move the cursor back to the previous digit. Pressing the **CLR** key when the cursor is on the first key of the code, or pressing the **CRSR** key during code entry, will remove the cursor and cancel data entry, restoring the previous code. You may press the **CLR** key up to five seconds after code entry is complete to return the cursor to the fourth digit. The numbers **8** and **9** are not used for code entry, only for entering a Count Down time, contrast and display brightness, and in the Configuration Mode.

IMPORTANT CODES:

- 1200 The VFR code for any altitude in the US (Refer to ICAO standards elsewhere)
 - 7000 The VFR code commonly used in Europe (Refer to ICAO standards)
 - 0021 The VFR code commonly used in Germany (default is set to 0021 at time of installation)
 - 7500 Hijack code (Aircraft is subject to unlawful interference)
 - 7600 Loss of communications
 - 7700 Emergency
 - 7777 Military interceptor operations (Never squawk this code)
 - 0000 Military use (Not enterable)
-

Avoid selecting code 7500 and all codes in the 7600-7777 range. These trigger special indicators in automated facilities. Only the code 7500 will be decoded as the hijack code. An aircraft's transponder code (if available) is utilized to enhance the tracking capabilities of the ATC facility, therefore care should be taken when making routine code changes.

915.1.3 KEYS FOR OTHER GTX 330 FUNCTIONS

IDENT

Pressing the IDENT key activates the Special Position Identification (SPI) Pulse for 18 seconds, identifying your transponder return from others on the air traffic controller's screen. The word 'IDENT' will appear in the upper left corner of the display while the IDENT mode is active.

VFR

Pressing the VFR key sets the transponder code to the pre-programmed VFR code selected in the Configuration Mode. Pressing the VFR key again will restore the previous identification code.

FUNC

Pressing the FUNC key changes the page shown on the right side of the display. Displayed data includes Pressure Altitude, Flight Time, Count Up timer, Count Down timers. In the Configuration Mode, steps through function pages.

START/STOP

Starts and stops the Count Up, Count Down and flight timers. In the Configuration Mode, steps through functions in reverse.

CRSR

Initiates starting time entry for the Count Down timer and cancels transponder code entry. Returns cursor to last code digit within five seconds after entry. Selects changeable fields in Configuration Mode.

CLR

Resets the Count Up and Count Down timers. Cancels the previous keypress during code selection and Count Down entry. Returns cursor to last code digit within five seconds after entry. Used in Configuration Mode.

8

Reduces Contrast and Display Brightness when the respective pages are displayed and enters the number eight into the Count Down timer. Used in Configuration Mode.

9

Increases Contrast and Display Brightness when the respective pages are displayed. Also enters the number nine into the Count Down timer. Used in Configuration Mode.

915.1.4 FUNCTION DISPLAY

'PRESSURE ALT'

Displays the altitude data supplied to GTX 330 in feet, hundreds of feet (i.e., flight level), or meters, depending on configuration. An arrow to the right of the altitude indicates that the airplane is climbing or descending.

'FLIGHT TIME'

Displays the Flight Time controlled by the **START/STOP** and **CLR** keys when Automated Airborne Determination is configured as normal.

'ALTITUDE MONITOR'

The ALTITUDE MONITOR function is not available in this installation.

'OAT/DALT'

The OAT/DALT function is not available in this installation (no temperature input).

'COUNT UP TIMER'

The count up timer is controlled by the **START/STOP** and **CLR** keys. Pressing the **CLR** key zeros the display.

'COUNT DOWN TIMER'

The count down timer is controlled by **START/STOP**, **CLR**, and **CRSR** keys. The initial Count Down time is entered with the **0-9** keys. Pressing the **CLR** key resets the timer to the initial value.

'STBY'

The transponder will not reply to any interrogations.

'GND'

This page is not active.

'CONTRAST'

This page is only displayed if manual contrast mode is selected in Configuration Mode. Contrast is controlled by the **8** and **9** keys.

'DISPLAY'

This page is only displayed if manual backlighting mode is selected on Configuration Mode. Backlighting is controlled by the **8** and **9** keys.

915.1.5 CONFIGURATION MODE

The configuration is normally set at time of installation, including the unique Mode S aircraft address. The configuration Mode should not be used during flight. Refer to the GTX 330 Pilot's Guide PN 190-00207-00 latest revision.

915.1.6 ALTITUDE TREND INDICATOR

When the **'PRESSURE ALT'** page is displayed, an arrow is displayed to the right of the altitude, indicating that the altitude is increasing or decreasing. One of two sizes of arrows is displayed depending on the rate of climb/&descent. The sensitivity of these arrows is set using the Configuration Mode vertical speed rate.

915.1.7 FAILURE ANNUNCIATION

If the unit detects an internal failure, the screen displays **'FAIL'**.

915.2 LIMITATIONS

Not applicable.

915.3 EMERGENCY PROCEDURES

915.3.1 IMPORTANT CODES

7600 Loss of communications.

7500 Hijacking.

7700 Emergency (All secondary surveillance radar sites are ready to receive this code at all times).

See the Airman's Information Manual (AIM) for a detailed explanation of identification codes.

915.4 NORMAL PROCEDURES

Not applicable.

915.5 PERFORMANCE

Not applicable.

Left blank intentionally

SECTION 916

BENDIX/KING KT 76A TRANSPONDER

Table of Contents

<i>Paragraph</i>		<i>Page</i>
916.1	GENERAL	916-3
916.1.1	Code Selection	916-3
916.1.2	Reply Light	916-4
916.1.3	Testing the KT 76A	916-4
916.2	LIMITATIONS	916-4
916.3	EMERGENCY PROCEDURE	916-4
916.4	NORMAL PROCEDURE:	916-5
916.4.1	Squawk Ident	916-5
916.5	PERFORMANCE	916-5

Left blank intentionally

916.1 GENERAL

The BENDIX/KING KT 76A panel mounted transponder receives interrogations at 1030 MHz, and these trigger a coded response of radar pulses, which are transmitted back to ATC at 1090 MHz. The return reinforces your aircraft's image or „blip“ on the controller's radar screen.

The KT 76A can reply to radar in any of 4096 preselected codes. Each code is identified by a unique group of pulses. With either an separate encoder, the KT 76A also provides ground radar with a continuous report of your altitude, which are automatically updated in 100-foot increments.

NOTE

The KT 76A owner accepts all responsibility for obtaining the proper license before using the transponder.

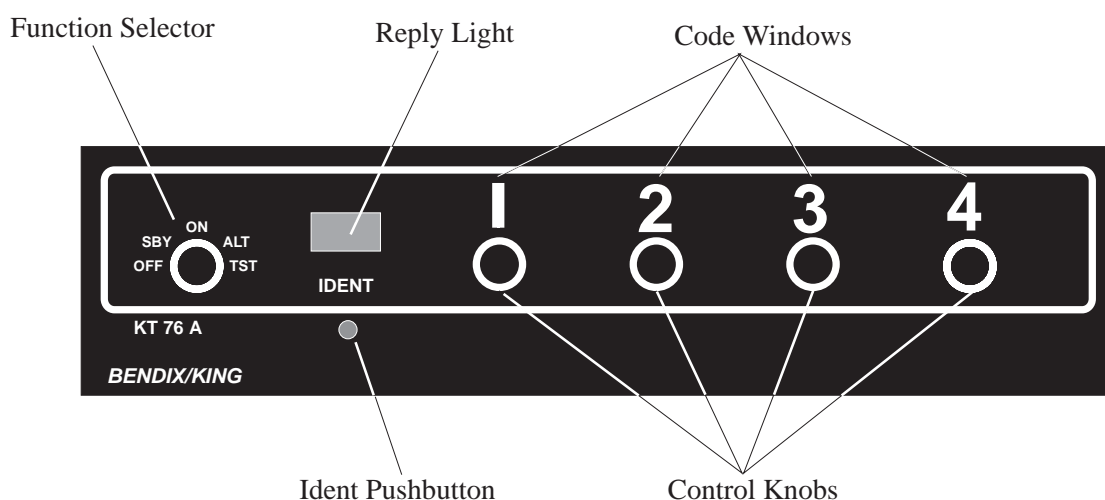

916.1.1 CODE SELECTION

The Identification Code selection is done with 4 ATRBS Code Selector Knobs that provide 4,096 active identification codes. Each of the 4 Code Selector Knobs selects a separate digit of the identification code. There is no need to move the „caret“ back to the first digit; it will automatically return after about five seconds. The KT 76A will retain the reply code through power shutdowns if the code has not been changed during the 5 seconds prior to removing power.

IMPORTANT CODES:

- 1200 The VFR code for any altitude in the US (Refer to ICAO standards elsewhere)
- 7000 The VFR code commonly used in Europe (Refer to ICAO standards)
- 0021 The VFR code commonly used in Germany (default is set to 0021 at time of installation)
- 7500 Hijack code (Aircraft is subject to unlawful interference)

7600 Loss of communications

7700 Emergency

7777 Military interceptor operations (Never squawk this code)

0000 Military use (Not enterable)

Avoid selecting code 7500 and all codes in the 7600-7777 range. These trigger special indicators in automated facilities. Only the code 7500 will be decoded as the hijack code. An aircraft's transponder code (if available) is utilized to enhance the tracking capabilities of the ATC facility, therefore care should be taken when making routine code changes.

916.1.2 REPLY LIGHT

During normal operation, the flashing Reply Light indicates that the KT 76A is functioning properly and replying to interrogations from ground radar. Interrogations occur at 10-15 second intervals, corresponding to each radar sweep. Frequently, the reply light will blink almost continuously, meaning that the transponder is responding to interrogations from several radar stations.

916.1.3 TESTING THE KT 76A

Allow a warm-up time of about 25 sec. before testing the KT 76A. Switching the function selector to the **TST** position a series of internal tests is performed to check the KT 76A. If no faults are detected the reply-light illuminates.

916.2 LIMITATIONS

Not Applicable.

916.3 EMERGENCY PROCEDURE

IMPORTANT CODES

7500	Use to report a hijacking.
7600	Signifies communication failure.
7700	Reserved for emergencies.

916.4 NORMAL PROCEDURE:

After engine start-up, turn the function selector to the Standby (**SBY**) position. Then select the proper reply code by rotating the code select knobs.

As soon as aircraft is airborne, switch the function selector to **ON**. Your KT 76A is now operating in „Mode A“, or normal mode. To operate in „Mode C“, or altitude reporting mode, turn the function selector to **ALT** (if aircraft is equipped with altitude encoding equipment).

916.4.1 SQUAWK IDENT

When you are asked to „ident“ by ATC, briefly press the **IDENT** push-button. Your aircraft will be positively identified to the Air Traffic Controller.

916.5 PERFORMANCE

Not Applicable

Left blank intentionally

SECTION 917

BENDIX/KING KT 73 TRANSPONDER

Table of Contents

<i>Paragraph</i>		<i>Page</i>
917.1	GENERAL	917-3
917.1a	Function Selector Knob	917-4
917.1b	Code Selection	917-4
917.1c	Buttons/selectors for other KT 73 Functions	917-5
917.1d	Function Display	917-6
917.1e	Programming Mode	917-6
917.1f	Air/Ground Switching	917-6
917.1g	Failure Annunciation	917-7
917.2	LIMITATIONS	917-7
917.3	EMERGENCY PROCEDURES	917-7
917.4	NORMAL PROCEDURES	917-7
917.5	PERFORMANCE	917-7

Left blank intentionally

917.1 GENERAL

The BENDIX/KING KT 73 panel mounted Mode S Transponder is a radio transmitter and receiver that fulfills the role of the airborne beacon equipment according to the requirements of the Air Traffic Radar Beacon System (ATCRBS). Its functionality includes replying to ATCRBS Mode A and C and Mode S interrogations. The Mode S function will allow the ground station to individually select the aircraft by its Aircraft Address assigned to the aircraft by the aviation agency.

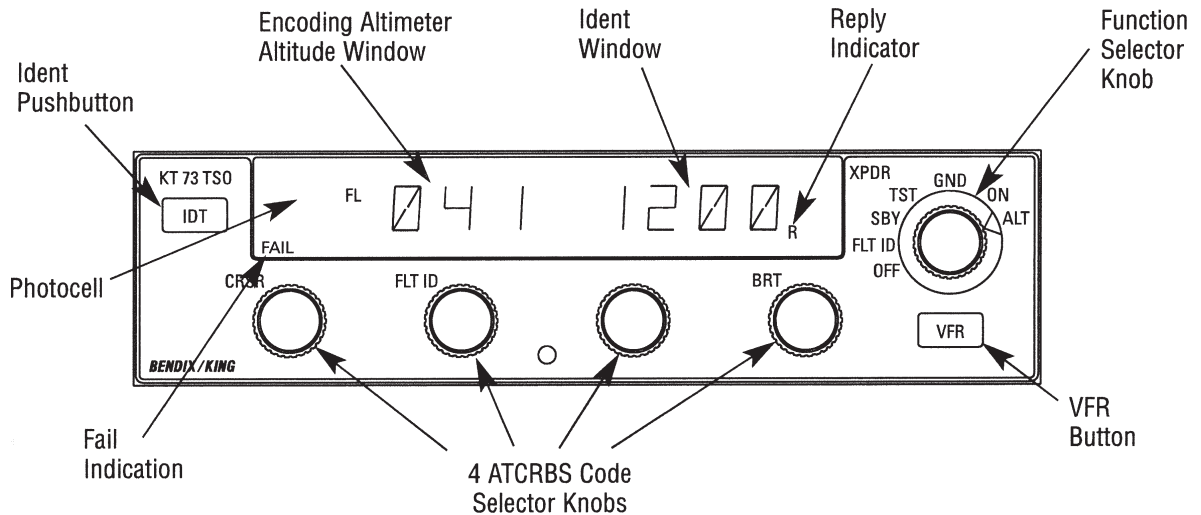

It operates on radar frequencies, receiving ground radar interrogations at 1030 MHz and transmitting a coded response of pulses to ground-based radar on a frequency of 1090 MHz.

The KT 73 is equipped with IDT (ident) capability that activates the Special Position Identification (SPI) pulse for 18 seconds.

In addition to displaying the code, reply symbol and mode of operation, the KT 73 screen will display pressure altitude. The displayed pressure altitude may not agree with the aircraft's baro-corrected altitude under non standard conditions.

The Traffic Information Service (TIS) and Automatic Dependent Surveillance-Broadcast (ADS-B) is not available in this installation.

NOTE

The KT 73 owner accepts all responsibility for obtaining the proper license before using the transponder.

The coverage you can expect from the KT 73 is limited to „line of sight“. Low altitude or aircraft antenna shielding by the aircraft itself may result in reduced range. Range can be improved by climbing to a higher altitude. It may be possible to minimize antenna shielding by locating the antenna where dead spots are only noticed during abnormal flight attitudes.

CAUTION

The KT 73 should be turned off before starting or shutting down aircraft engine.

The KT 73 Transponder is powered on by rotating the Function Selector Knob from the **OFF** position to any functional mode position.

917.1A FUNCTION SELECTOR KNOB

The following operating modes can be chosen by the Function Selector Knob:

OFF

Powers off the KT 73. When the unit is turned to another mode, it will reply or squitter within two seconds, according to the selected mode.

FLT ID

Selects the Flight ID mode displaying the 8 character Flight ID or registration marking of the airplane. When in Flight ID mode, the transponder will not reply to any interrogations.

SBY

Selects the Standby mode displaying the last active identification code. When in Standby mode, the transponder is energized but will not reply to any interrogations.

TST

Selects the Test mode displaying all display segments for a minimum of 4 seconds. A series of internal tests is performed to check its integrity, verify all aircraft specific configuration data and make hardware and squitter checks. When in Flight ID mode, the transponder will not reply to any interrogations. In addition the display brightness can be manually adjusted by rotating the **BRT** knob.

GND

Selects the Ground mode displaying '**GND**' in the altitude window. When in Ground mode, the transponder will not reply to ATCRBS, ATCRBS/Modes S All-Call and Mode S-only All-Call interrogations. It will continue to generate Mode S squitter transmissions and reply to discretely addressed Mode S interrogations.

ON

Powers on the transponder in Mode A, C and S. In this mode the transponder replies to interrogations, as indicated by the Reply Symbol. Replies do not include altitude information.

ALT

Powers on the transponder in Mode A, C and Mode C. In ALT mode, the transponder replies to identification and altitude interrogations, as indicated by the Reply Symbol. Replies to altitude interrogations include standard pressure altitude received from a separate encoder.

917.1B CODE SELECTION

The Identification Code selection is done with 4 ATCRBS Code Selector Knobs that provide 4,096 active identification codes. Each of the 4 Code Selector Knobs selects a separate digit of the identification code.

IMPORTANT CODES:

1200 The VFR code for any altitude in the US (Refer to ICAO standards elsewhere)

7000 The VFR code commonly used in Europe (Refer to ICAO standards)

0021 The VFR code commonly used in Germany (default is set to 0021 at time of installation)

7500 Hijack code (Aircraft is subject to unlawful interference)

7600 Loss of communications

7700 Emergency

7777 Military interceptor operations (Never squawk this code)

0000 Military use (Not enterable)

Changing the preset VFR code is done as follows:

Place the unit in SBY

Select the desired VFR code

While holding the **IDT** button in, momentarily press the **VFR** button.

Avoid selecting code 7500 and all codes in the 7600-7777 range. These trigger special indicators in automated facilities. Only the code 7500 will be decoded as the hijack code. An aircraft's transponder code (if available) is utilized to enhance the tracking capabilities of the ATC facility, therefore care should be taken when making routine code changes.

917.1C BUTTONS/SELECTORS FOR OTHER KT 73 FUNCTIONS

IDT

Pressing the **IDT** (Ident) button while in the GND, ON or ALT mode activates the Special Position Identification (SPI) Pulse for 18 seconds, identifying your transponder return from others on the air traffic controller's screen. The word '**IDT**' will appear in the left lower corner of the altitude window while the IDT mode is active. When the Function Selector Knob in test mode (**TST**), pressing the **IDT** button will return the brightness to the default factory value.

VFR

Momentarily pressing the **VFR** Pushbutton sets the transponder code to the pre-programmed VFR code, superseding whatever code was previously entered. Pressing the **VFR** key again and holding it for two seconds will restore the previous identification code. When in TST mode pushing the **VFR** button will display the software revisions on the Altitude window and Ident window for a minimum of 4 seconds.

FLT ID

When in FLT ID mode, the flight ID can be entered or modified by rotating the **FLT ID** knob (= 2nd ATCRBS Code Selector Knob) to select desired character for each digit selected by the **CRSR** knob. Once the **CRSR** and **FLT ID** knobs have been idle for 5 seconds or the Function Selector Knob has been turned to the **SBY** position the flight ID will be saved.

CRSR

When in FLT ID mode, rotating the **CRSR** knob (= 1st ATCRBS Code Selector Knob) will position the cursor under the character of the flight ID to be changed.

BRT

When in TST mode, rotating the **BRT** knob (= 4th ATRBS Code Selector Knob) will manually adjust the display brightness. Clockwise rotating will increase display brightness and counterclockwise will decrease display brightness. The brightness of the display is determined by a photocell relative to the programmed or manual adjusted brightness level.

917.1D FUNCTION DISPLAY

'FL'

When the ALT mode is selected, the letters **'FL'** will be illuminated. The pressure altitude data supplied to the KT 73 is displayed in hundreds of feet (i.e., Flight Level) on the left side of the display, the altitude window. In addition the ID code is displayed in the right window, the ident window. A fault in the altitude interface or an invalid altitude input to the KT 73 will cause the display to show a series of dashes when the ALT mode is selected.

'SBY'

'SBY' is displayed in the altitude window when SBY mode is selected by the Function Selector Knob. In addition the ID code is displayed in the right window, the ident window.

'GND'

'GND' is only displayed on the left side (altitude window) when the aircraft is on ground. The ID code is shown on the right side, the ident window.

'FLT IDT'

The **'FLT IDT'** is annunciated and the flight ID is illuminated in the display area when the FLT ID mode is selected by the Function Selector Knob.

'TEST OK'

'TEST OK' is displayed in the Test mode if no faults are detected.

'SBY FXYZ'

If one or more fault is detected in the Test mode, **'SBY'** is displayed in the altitude window and the ident window will cycle through all detected faults indicated by **'FXYZ'**. The **'XYZ'** denotes the specific fault.

917.1E PROGRAMMING MODE

The programming mode is normally set at time of installation, including the unique Mode S aircraft address. The programming mode should not be used during flight. Refer to the KT 73 Installation Manual 006-10563-0004 latest revision.

917.1F AIR/GROUND SWITCHING

The AUTO GND (Automatic Ground Programming) function is not available.

917.1G FAILURE ANNUNCIATION

If the unit detects an internal failure, FAIL annunciation light on the left side of the displays will illuminate.

917.2 LIMITATIONS

Not applicable.

917.3 EMERGENCY PROCEDURES

IMPORTANT CODES

7600 Loss of communications.

7500 Hijacking.

7700 Emergency (All secondary surveillance radar sites are ready to receive this code at all times).

See the Airman's Information Manual (AIM) for a detailed explanation of identification codes.

917.4 NORMAL PROCEDURES

Not applicable.

917.5 PERFORMANCE

Not applicable.

Left blank intentionally

SECTION 918

BECKER ATC 2000 TRANSPONDER

Table of Contents

<i>Paragraph</i>		<i>Page</i>
918.1	GENERAL	918-3
918.1.1	Built-in Test	918-4
918.1.2	Squawk selection	918-4
918.1.3	Mode A Operation	918-5
918.1.4	Mode A and C Operation	918-5
918.2	LIMITATIONS	918-5
918.3	EMERGENCY PROCEDURES	918-5
918.3.1	Important Codes	918-5
918.4	NORMAL PROCEDURES	918-6
918.5	PERFORMANCE	918-6

Left blank intentionally

918.1 GENERAL

The Becker panel mounted ATC 2000 Transponder is a radio transmitter and receiver that fulfills the role of the airborne beacon equipment according to the requirements of the Air Traffic Radar Beacon System (ATCRBS). Its functionality includes replying to ATCRBS Mode A and Mode C interrogations.

It operates on radar frequencies, receiving ground radar interrogations at 1030 MHz and transmitting a coded response of pulses to ground-based radar on a frequency of 1090 MHz. The ATC 2000 is equipped with IDENT capability that activates the Special Position Identification (SPI) pulse.

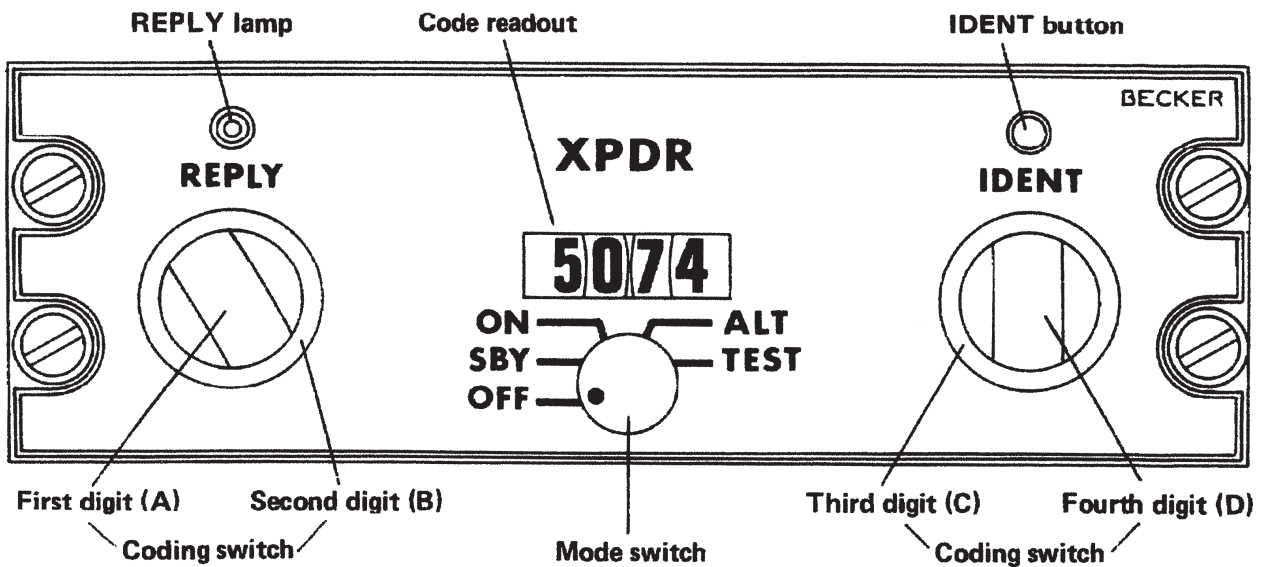

Controls	Description	Function
OFF/SBY/ON/ALT/TEST mode switch	Four-Position rotary switch and one key position	OFF Transponder is switched off (with exception of panel lighting)
		SBY Transmitter tube warm-up
		ON Transponder responds to mode A interrogation with the set code
		ALT Transponder responds to mode A and mode C interrogation
TEST Built-in test by interrogation simulation, REPLY lamp must light up		
IDENT button	Pushbutton	Pressing the IDENT button the transponder transmits an SPI pulse
REPLY lamp	Lamp, orange, with dimmer	Lights up if transponder responds; intensity set by means of a mechanical dimmer
4 coding switches	Rotary switches with eight positions	Setting the code from 0000 to 7777 permitting 4096 different digit combinations
Code readout	Digital readout, each digit from 0 to 7	Indication of coding from 0000 to 7777

NOTE

The ATC 2000 owner accepts all responsibility for obtaining the proper license before using the transponder.

Caution

Do not switch on or off the transponder until the engines have been started or stopped respectively to avoid damage to the transponder due to current surges.

918.1.1 BUILT-IN TEST

- 1 Position mode switch from **OFF** to **SBY**. Operate the transponder approx. 60s in the SBY position since transmitting tube must warm up and stabilize prior to operation. It is, however, possible to skip the **SBY** position without danger for the transmitter tube, since the latter is safeguarded by cavity protection circuit which also requires approx. 60s to warm up.
- 2 Turn mode switch as far as it will go to **TEST** (key position) in which the transponder simulates interrogation, prompting a reply. The reply indication is given by the reply lamp illuminating.

918.1.2 SQUAWK SELECTION

Squawk selection is done with the four rotating knobs to provide 4096 identification codes. Important Codes:

1200 The VFR code for any altitude in the US (Refer to ICAO standards elsewhere)

7000 The VFR code commonly used in Europe (Refer to ICAO standards)

0021 The VFR code commonly used in Germany (default is set to 0021 at time of installation)

7500 Hijack code (Aircraft is subject to unlawful interference)

7600 Loss of communications

7700 Emergency

7777 Military interceptor operations (Never squawk this code)

0000 Military use (Not enterable)

Avoid selecting code 7500 and all codes in the 7600-7777 range. These trigger special indicators in automated facilities. Only the code 7500 will be decoded as the hijack code. An aircraft's transponder code (if available) is utilized to enhance the tracking capabilities of the ATC facility, therefore care should be taken when making routine code changes.

918.1.3 MODE A OPERATION

- 1 Activate the transponder on ATC request only. To ensure instant readiness, position the mode switch to **SBY** (standby) during the flight.
- 2 Set the code requested by ATC using the four coding switches. Set two-digit code numbers in the first two windows of the readout.

Caution

Only operate the coding switches in the SBY (standby) mode.

- 3 Switch the mode switch **ON** on ATC request, the transponder then responding to mode A interrogation with dialed code, as indicated by the REPLY lamp coming on.
- 4 Only press the **IDENT** button briefly when requested by ATC, causing a special identification pulse (SPI pulse) being transmitted, permitting instant identification of the aircraft on the ATC radar system.

918.1.4 MODE A AND C OPERATION

- 1 Position mode switch to **ALT** on ATC request only. The transponder then responds with dialed code, causing REPLY lamp to light up and additionally transmits the height of the aircraft to ATC.
- 2 Press the **IDENT** button briefly when requested by ATC, causing a special identification pulse (SPI pulse) being transmitted, permitting instant identification of the aircraft on the ATC radar system.

918.2 LIMITATIONS

Not applicable.

918.3 EMERGENCY PROCEDURES

918.3.1 IMPORTANT CODES

7600 Loss of communications.

7500 Hijacking.

7700 Emergency (All secondary surveillance radar sites are ready to receive this code at all times).

See the Airman's Information Manual (AIM) for a detailed explanation of identification codes.

918.4 NORMAL PROCEDURES

Not applicable

918.5 PERFORMANCE

Not applicable

SECTION 919

BECKER ATC 4401 TRANSPONDER

Table of Contents

<i>Paragraph</i>		<i>Page</i>
919.1	GENERAL	919-3
919.1.1	Controls and indicators	919-4
919.1.2	Switching on the unit (pre-flight check)	919-4
919.1.3	Squawk selection	919-5
919.1.4	Flight operation in Mode A (transponder reply code only)	919-7
919.1.5	Flight operation in Mode A+C (reply code and altitude code)	919-7
919.1.6	Squawk Ident	919-7
919.1.7	Test	919-7
919.1.8	Configuration Mode	919-8
919.2	LIMITATIONS	919-8
919.3	EMERGENCY PROCEDURES	919-8
919.3.1	Important Codes	919-8
919.4	NORMAL PROCEDURES	919-8
919.5	PERFORMANCE	919-8

Left blank intentionally

919.1 GENERAL

The Becker panel mounted ATC 4401 Transponder is a radio transmitter and receiver that fulfills the role of the airborne beacon equipment according to the requirements of the Air Traffic Radar Beacon System (ATCRBS). Its functionality includes replying to ATCRBS Mode A and Mode C interrogations.

It operates on radar frequencies, receiving ground radar interrogations at 1030 MHz and transmitting a coded response of pulses to ground-based radar on a frequency of 1090 MHz. The ATC 4401 is equipped with IDENT capability that activates the Special Position Identification (SPI) pulse.

NOTE

The ATC 4401 owner accepts all responsibility for obtaining the proper license before using the transponder. Refer to Becker Pilot's Guide.

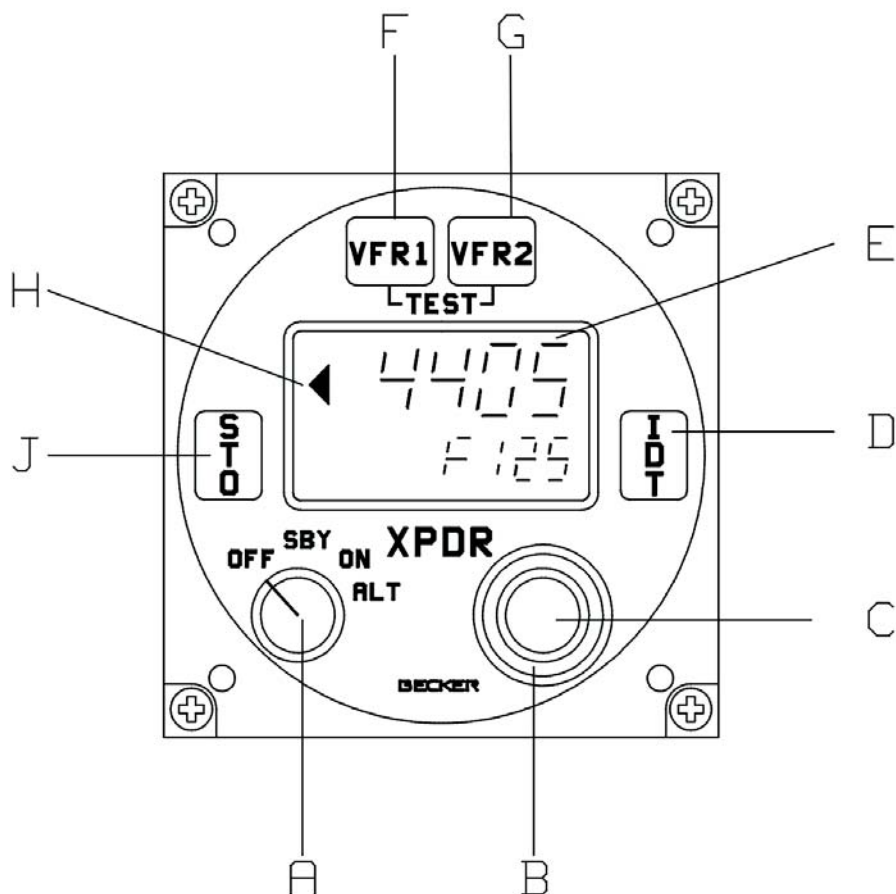

919.1.1 CONTROLS AND INDICATORS

A	OFF/SBY/ON/ALT rotary mode switch with 4 detent positions	OFF position : Transponder is switched off (expect panel lighting). SBY position : Standby mode is switched on. ON position : Mode A is switched on. ALT position : Mode A+C is switched on.
B	Rotary coding switch with 8 detents positions, continuously rotatable	Control of the cursor in one of the 4 code digits or from the display field
C	Rotary coding switch with 8 detents positions continuously rotatable	Setting the code digits from 0 to 7.
D	Ident push-button IDT	In Mode A and Mode A+C this triggers the transmission of an identification impulse additional to the Mode A reply code for approx. 18 seconds. During this time "ldt" appears in the bottom line of the LC display.
E	2-line LC display	Code indication (top line): Codes from 0000 to 7777 are possible.
		"Mode indication (bottom line) : SBY mode: ""SbY"" is displayed."
		"Mode A (ON): ""On"" appears in the display ""IDT"" is displayed the duration of the identification function."
		"Mode A+C (ALT):If a valid altitude is present, the flight level (height in steps of 100 ft) preceded by F (e.g. ""F241""= 24100 ft) appears. If no valid altitude code is present, ""FN-"" is displayed. The flight level display can be switched off in the configuration mode. ""ldt"" is displayed for the duration of the identification function."
F	Code push-button VFR1	Activates a first user-specific VFR code
G	Code push-button VFR2	Activates a second user-specific VFR code.
H	Reply indication REPLY	The triangle signals a Transponder reply.
J	Store push-button STO	Stores user-specific VFR codes or changes in the configuration mode

919.1.2 SWITCHING ON THE UNIT (PRE-FLIGHT CHECK)

- 1 Check that the circuit breaker is set and switch on the aircraft power supply .

CAUTION

Do not switch on the transponder if the motors or engines are being started or shut down.

- 2 Using mode switch (A), switch the transponder from **OFF** to **SBY**. A test then follows automatically for 3 seconds. The display is flashing with all digits and the unit is subject to a self-test simultaneously.

- 3 After the switch-on test has elapsed and no error-message is written in the display, the transponder switches to the mode set on the mode switch (A).

Note

The blind encoder is only powered if the transponder is not switched OFF (at least SBY). A blind encoder needs a warm-up time (sometimes a several minutes). Therefore although the solid state transponder needs no warm-up time, turn the transponder to SBY immediately after starting the engine.

919.1.3 SQUAWK SELECTION

- 1 The transponder remains switched in the standby mode until requested by the ground station (ATC) to transmit a code, e.g. „squawk alpha 6426“.
- 2 Using the double rotary switch (B,C) set the 4-digit code requested by ATC as follows :
 - a Using switch (B) move the cursor to the particular digit. Digits 0 to 7 can then be set using switch (C).

NOTES

If switch (B) is turned clockwise or counter-clockwise, the cursor is moved one position to the right or the left. The cursor appears only in the code display and is indicated by the flashing digit. If no cursor is visible, the first digit flashes after a clockwise rotation and the last digit after a counter-clockwise rotation. When the code is being changed in the ON or ALT position, the transponder temporarily switches to the standby mode.

The active time of the cursor and the rate of flashing can be changed in the configuration mode.

- b If the cursor is not moved again within of 3 seconds (can be changed in configuration mode) or if the cursor is moved so far that it can no longer be seen in the display field or the identification switch is pressed (in the ON or ALT mode), the code currently set is switched active.

NOTES

Whilst settings are taking place, the transmission branch of the transponder is inhibited to prevent unintentional transmission.

If only two digits were named by ATC, e.g. „Squawk alpha 64“, then a zero is to be used for positions three and four, i.e. „6400“.

- c The last used code is stored in each case and is also activated when the transponder is switched on.

SPECIAL VFR CODINGS

Two user-specific VFR codes can be stored and activated on the transponder.

- 1 Storing a new VFR code:
 - a Set the code to be stored in accordance with section B.

- b Press store push-button **STO** (J), the set code then flashes.
- c Press the **VFR1** push-button (F) or the **VFR2** push-button (G) within 3 seconds to store the code under the corresponding button.
- d If neither button (F) or (G) is pressed within 3 seconds, the flashing stops and the storage operation is aborted.

NOTE

If one of the two buttons (F) or (G) is pressed without the STO button having been pressed beforehand, then the stored code allocated this button appears in the code display and is switched to active after 3 seconds (can be changed in the configuration mode). If the same button is again pressed within 3 seconds, the previous code appears.

2 Activation of the VFR codes:

- a Press the **VFR** push-button **1** or **2** (F, G). The selected code is then displayed. After 3 seconds, the displayed code becomes active and overwrites the previously-set reply code.
- b Pressing button (F) or (G) again within 3 seconds reactivates the previously-set reply code.

NOTE

When the unit is delivered, the store buttons are not assigned a code. This means that if these buttons are pressed for 0.5 seconds, „—“ is shown in the code display and the transponder then switches back to the previously-active code.

IMPORTANT CODES:

- 1200 The VFR code for any altitude in the US (Refer to ICAO standards elsewhere)
- 7000 The VFR code commonly used in Europe (Refer to ICAO standards)
- 0021 The VFR code commonly used in Germany (default is set to 0021 at time of installation)
- 7500 Hijack code (Aircraft is subject to unlawful interference)
- 7600 Loss of communications
- 7700 Emergency
- 7777 Military interceptor operations (Never squawk this code)
- 0000 Military use (Not enterable)

Avoid selecting code 7500 and all codes in the 7600-7777 range. These trigger special indicators in automated facilities. Only the code 7500 will be decoded as the hijack code. An aircraft's transponder code (if available) is utilized to enhance the tracking capabilities of the ATC facility, therefore care should be taken when making routine code changes.

Note

Unintentional transmission of an emergency code is prevented in that the transponder replies are inhibited whilst the code is being set. This applies particularly where the new code is being set in the ON or ALT modes. Also if a special code is called up, no transponder reply takes place during the period in which the previous code can be reactivated (approximately 3 seconds).

919.1.4 FLIGHT OPERATION IN MODE A (TRANSPONDER REPLY CODE ONLY)

- 1 Select squawk as described above.
- 2 Set mode switch (A) from **SBY** to **ON**. The transponder immediately replies with the set code. A triangle on the left next to the code signals the transponder replies.

919.1.5 FLIGHT OPERATION IN MODE A+C (REPLY CODE AND ALTITUDE CODE)

- 1 Select squawk as described above.
- 2 ATC requests the transmission „alpha/charlie“ or „charlie“, switch the transponder to **ALT** using mode switch (A).
- 3 The transponder replies using the code set and in response to mode C requests it transmits the flight level of the aircraft to ATC. A triangle on the left next to the code signals the transponder replies.

919.1.6 SQUAWK IDENT

After a „squawk ident“ request from ATC, press Ident button **IDT** (D) briefly. This transmits an additional special pulse (SPI) for approx. 18 seconds, which enables the aircraft to be clearly identified on the radar screen of the controller. **'Idt'** appears in the bottom line of the LC display during this time.

919.1.7 TEST

The following different tests are integrated in the transponder or can be triggered at the transponder :

- 1 Automatic switching-on test, in which the display (E) is flashing with all digits for 3 seconds. The unit is subject to a self-test in this time.
- 2 A permanent test runs in the background of the transponder operation. The built-in FPGA organizes the required resources for this. The transmitter recognizes a mismatching or own abnormal behavior and delivers an alarm signal to the FPGA.

- 3 A further test of the unit is triggered, if the **VFR1** button (F) and **VFR2** button (G) are pressed simultaneously. At this test all segments must flash into display (E) as long as the buttons are pushed. Additionally the transmitter and evaluation are tested on correct function in the SBY, ON and ALT modes.
- 4 In case of a failure appears the report e.g. '**E10**' in the top line of the display. Switch OFF the transponder at such '**E**' fault indications.

919.1.8 CONFIGURATION MODE

The configuration Mode is used to set the unit on the ground and must not be called up in flight. Refer to BECKER's Pilot's Guide for further information.

919.2 LIMITATIONS

Not applicable.

919.3 EMERGENCY PROCEDURES

919.3.1 IMPORTANT CODES

7600 Loss of communications.

7500 Hijacking.

7700 Emergency (All secondary surveillance radar sites are ready to receive this code at all times).

See the Airman's Information Manual (AIM) for a detailed explanation of identification codes.

919.4 NORMAL PROCEDURES

Not applicable

919.5 PERFORMANCE

Not applicable

SECTION 920

BECKER ATC 6401 TRANSPONDER

Table of Contents

<i>Paragraph</i>		<i>Page</i>
920.1	GENERAL	920-3
920.1.1	Controls and Indicators	920-4
920.1.2	Switching on the Unit (pre-flight check)	920-4
920.1.3	Display	920-5
920.1.4	Squawk Selection	920-5
920.1.5	Squawk Ident	920-6
920.1.6	Selftests of the Unit (BITs)	920-6
920.1.7	Selection Mode	920-7
920.1.8	Flight Operation in Mode A/C/S (reply code and altitude code)	920-9
920.1.9	VFR Code Activation	920-10
920.1.10	Configuration Mode	920-10
920.2	LIMITATIONS	920-10
920.3	EMERGENCY PROCEDURES	920-10
920.3.1	Important Codes	920-10
920.4	NORMAL PROCEDURES	920-10
920.5	PERFORMANCE	920-10

Left blank intentionally

920.1 GENERAL

The Becker panel mounted ATC 6401 Transponder is a radio transmitter and receiver that fulfills the role of the airborne beacon equipment according to the requirements of the Air Traffic Radar Beacon System (ATCRBS). Its functionality includes replying to ATCRBS Mode A, C and Mode S interrogations.

It operates on radar frequencies, receiving ground radar interrogations at 1030 MHz and transmitting a coded response of pulses to ground-based radar on a frequency of 1090 MHz. The ATC 6401 is equipped with IDENT capability that activates the Special Position Identification (SPI) pulse.

NOTE

The ATC 6401 owner accepts all responsibility for obtaining the proper license before using the transponder. Refer to Becker Pilot's Guide.

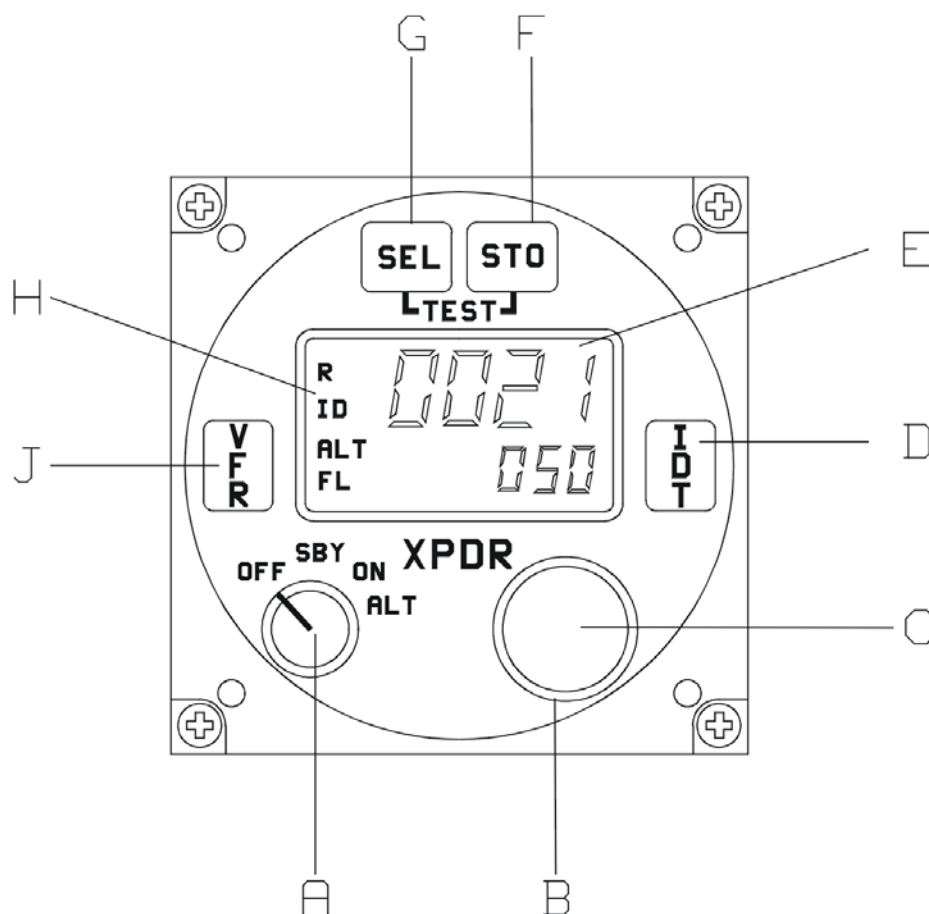

920.1.1 CONTROLS AND INDICATORS

A	Mode Selector	Rotary switch with 4 positions	OFF position : Transponder is switched off SBY position : Standby mode is switched on ON position: Mode A/S is switched on. Transmission of altitude information is suppressed ALT position: Mode A/C/S is switched on and the altitude information is transmitted.
B	Rotary switch	Rotary optical encoder (rotary mode of C)	Rotary switch to change settings (16 steps per turn)
C	Button	Push-button (mode of B)	Push to jump from digit to digit for settings or from one menu to the next; generally used as an enter key
D	IDT	Push-button	Activates the Special Identifier (SPI) in addition to the reply code for approx. 18 seconds; during this time "ID" appears in the LC display
E	Display, part 1	2-line LCD display	Displays the following informations: - code indication in the top row - flight level in the bottom row - various informations in the bottom row - additional indicators on the left side (see Ref. H)
F	STO	Push-button	Stores the selected values to the settings
G	SEL	Push-button	Opens and selects the menu
H	Display, part 2	LCD indicators	Displays additional indicators, (R for reply, ID for Ident, ALT for XPDR ALT mode or ON for XPDR ON mode, FL for flight level)
J	VFR	Push-button	Activates VFR code in the upper row of the display

920.1.2 SWITCHING ON THE UNIT (PRE-FLIGHT CHECK)

- 1 Check that the circuit breaker is set and switch on the aircraft power supply .

CAUTION

Do not switch on the transponder if the motors or engines are being started or shut down.

- 2 Using mode selector (A), switch the transponder from **OFF** to **SBY**. A test then follows automatically for 1 seconds. The display shows '**WAIT**' and the unit is subject to a self-test simultaneously.
- 3 After the switch-on test has elapsed and no error-message is written in the display, the transponder switches to the mode set on the mode selector (A).

Note

The blind encoder is only powered if the transponder is not switched OFF (at least SBY). A blind encoder needs a warm-up time (sometimes a several minutes). Therefore although the solid state transponder needs no warm-up time, turn the transponder to SBY immediately after starting the engine.

920.1.3 DISPLAY

Transponder's code is displayed in the top line using high readability font, at all times in modes SBY, ON, ALT. Depending on the configuration settings, the Aircraft Identification (AI) or Flight Number (FN) is displayed in the bottom line. Flight level is displayed in ALT mode in the bottom line of the display (altitude= FL x 100 in ft).

920.1.4 SQUAWK SELECTION

- 1 The transponder remains switched in the standby mode until requested by the ground station (ATC) to transmit a code, e.g. „squawk alpha 6426“.
- 2 Using the rotary switch (B) and the button (C) set the 4-digit code requested by ATC as follows:
 - a Using switch (C) move the cursor to the particular digit. Digits 0 to 7 can then be set using the rotary switch (B).

NOTES

Whilst settings are taking place, the transmission branch of the transponder is inhibited to prevent unintentional transmission.

If only two digits were named by ATC, e.g. „Squawk alpha 64“, then a zero is to be used for positions three and four, i.e. „6400“.

- b The last used code is stored in each case and is also activated when the transponder is switched on.

IMPORTANT CODES:

- 1200 The VFR code for any altitude in the US (Refer to ICAO standards elsewhere)
- 7000 The VFR code commonly used in Europe (Refer to ICAO standards)
- 0021 The VFR code commonly used in Germany (default is set to 0021 at time of installation)
- 7500 Hijack code (Aircraft is subject to unlawful interference)
- 7600 Loss of communications
- 7700 Emergency

7777 Military interceptor operations (Never squawk this code)

0000 Military use (Not enterable)

Avoid selecting code 7500 and all codes in the 7600-7777 range. These trigger special indicators in automated facilities. Only the code 7500 will be decoded as the hijack code. An aircraft's transponder code (if available) is utilized to enhance the tracking capabilities of the ATC facility, therefore care should be taken when making routine code changes.

Note

Unintentional transmission of an emergency code is prevented in that the transponder replies are inhibited whilst the code is being set. This applies particularly where the new code is being set in the ON or ALT modes. Also if a special code is called up, no transponder reply takes place during the period in which the previous code can be reactivated (approximately 3 seconds).

920.1.5 SQUAWK IDENT

After a „squawk ident“ request from ATC, press Ident button **IDT** (D) briefly. This transmits an additional special pulse (SPI) for approx. 18 seconds, which enables the aircraft to be clearly identified on the radar screen of the controller. '**Idt**' appears in the bottom line of the LC display during this time.

920.1.6 SELFTESTS OF THE UNIT (BITS)

The following different tests are integrated in the transponder or can be triggered at the transponder:

- 1 The IBIT (Initiated Built-in Test) can be activated in any mode (excluding the configuration mode) with the push of (F) and (G) at the same time. The action starts with the leading edge of the second pushed button. The IBIT works as follows in all modes:

The test starts with all available test routines including the transmitter test routine. During the test, '**IBIT**' is indicated on the display. The test takes not longer than 1 second. If the IBIT was successful, the XPDR switches immediately into the normal operating mode. During the IBIT any action from other switches is not recognized.

Negative results of the IBIT are indicated on the display with '**FAILURE**'. The transponder may be not switched into ON or ALT mode if any failure was found.

- 2 The CBIT (Continuous Built-in Test) works as follows:

The continuous BIT acts as a kind of watchdog during operation. Negative results of the CBIT are indicated on the display with '**FAILURE**'. In this case the transponder may be not switched into ON or ALT mode (display indication of operating mode set to '**SBY**') if any failure was found.

- 3 The PBIT (Power-on Built-in Test) works as follows:

The XPDR has a power-on BIT after switching on. During the PBIT any action from other switches are not accepted.

During the PBIT the XPDR is in the SBY mode but this is not indicated on the display. The operating mode indication on the display starts immediately after finalisation of the PBIT.

Negative results are indicated on the display with '**FAILURE**'. The transponder may be not switched into ON or ALT mode if any failure was found.

The PBIT takes not longer than 1 second. If the test was successful, the XPDR switches immediately into the normal operating mode.

920.1.7 SELECTION MODE

Press **SEL** button (G) and rotate encoder (B) for selection. In selection mode additional information is displayed in the bottom line of the display. Some of the data are editable, some are read only:

VFR	4096 code presetting	editable
AI	Aircraft Identifier (Tail Number)	fixed; read only from address module (an be replaced by FN). If no valid AI is stored, "-----" is displayed.
FN	Flight Number or Company Call Sign	editable; can be replaced by AI (fixed) by selecting "AI DEF"
AA	Aircraft Address (24-bit ICAO)	fixed; read only from address module (unique number for each aircraft)
MA	Maximum Airspeed	fixed; read only from address module
AT	Aircraft Type	fixed; read only from address module
CFG	Configuration	available in SBY mode only
INS	Installation setup	available in SBY mode only; protected by password

AIRCRAFT IDENTIFICATION (AI OR FN)

With flight plan:

The definition out of the flight plan: e.g. Flight Number or Company Call Sign

Without flight plan (VFR):

Tail Number (Call Sign)

The indication of '**AI**' in the bottom line of the display is in mode SBY and ON only if selected in configuration menu. The Aircraft Identifier (fixed) is available in any mode after pressing **SEL** button (G) and turning the rotary encoder (B). The default value for AI is the Tail Number of the aircraft and is stored in the Address Module.

If a flight plan exists, it has to be checked, which AI has to be used. If a Flight Number is assigned it has to be entered. If a Company Call Sign is mentioned, this has to be entered. To enter it see below. It will be stored in the EEPROM of the control head. In this case the indication on the display changes to '**FN**' (Flight Number). If the Call Sign (Tail Number) is mentioned, no change, as it is the default setting from the Address Module.

SETTING THE FLIGHT NUMBER:

- 1 Press **SEL** button (G) to enter the select mode.
- 2 Rotate (B) until '**AI**' is displayed.
- 3 Push (C) to switch to '**FN**'. The cursor is set on the first character.
- 4 Rotate (B) to change this character.
- 5 Push (C) to set the cursor to the next character.
- 6 Repeat steps 4 and 5 until the flight number is entered.
- 7 If the flight number consists of less than 7 characters, put a space at the end to fill the remaining characters with spaces.
- 8 Store the changes with **STO** button (F). For leaving the setting procedure without storing, push the **SEL** button (G).

NOTE

Aircraft Identifier / Flight Number consists of max. 7 characters (on the left- hand side oriented). No dashes or spaces shall be included. If the FN consists of less than 7 characters, the remaining characters on the right side shall be filled with spaces.

SWITCHING BACK TO DEFAULT AI:

- 1 Press **SEL** button (G) to enter the select mode.
- 2 Rotate (B) to the indication '**FN=XXXXXXXX**'.
- 3 First push on (C) indicates '**FN=AI DEF**' (inverted).
- 4 Can be set to '**AI=DEF**' with **STO** button (F).

CHANGING THE FLIGHT NUMBER:

- 1 Press **SEL** button (G).
- 2 Rotate (B) until '**FN**' is displayed.
- 3 Push (C) twice to enter the FN editing mode.
- 4 Change the FN as described above.

VFR CODE PRESETTING

Press the **SEL** button (G) to get into configuration mode (selection is indicated in the left bottom corner of the display under the operating mode indication).

- 1 Rotate (B) to the indication '**VFR=XXXX**'.
- 2 First push to button (C) now left digit of the code is inverted.
- 3 Now the digit can be changed with (B).
- 4 Second push to button (C) now next left digit of the code is inverted.
- 5 The next digit can be changed with (B)
- 6 and the same for next digits.
- 7 Fifth push to button (C) now again first digit is inverted.
- 8 Changes can be stored with **STO** button (F) at any time, inversion stops in this case.
- 9 A VFR code that was preset in this way can be activated as described in chapter *VFR Code Activation*.
- 10 A timeout for inversion (10 sec) is introduced if no action happens. Nothing stored, as long as (F) is not pressed.

NOTE

It is possible to leave the setting procedure with SEL button (G) at any time and normal mode is available then. Indication SEL on the display changes back to mode indication. If STO button (F) was not used, no change has been stored.

920.1.8 FLIGHT OPERATION IN MODE A/C/S (REPLY CODE AND ALTITUDE CODE)

- 1 When ATC requests the transmission „squawk“, switch the transponder to **ALT** using mode switch (A).

NOTE

In exceptions the altitude has to be turned off, i.e. switch the transponder to ON using mode switch (A).

- 2 The transponder replies using the selected Code and in response to mode C interrogation it transmits the altitude of the aircraft to ATC. A 'R' on the left next to the Code on the display signals the transponder replies.

NOTE

Switch the transponder to Stand-by (SBY), if the Code has to be changed. Otherwise it could happen that a Code with a special meaning (see chapter K, e.g. highjack) will be transmitted and unwanted actions could take place.

920.1.9 VFR CODE ACTIVATION

- 1 Press the **VFR** push-button (J). The preselected code is then displayed. After 3 seconds, the displayed code gets active and overwrites the previously-set reply code.
- 2 Pressing push-button (J) again within 3 seconds reactivates the previously-set reply code.

NOTE

When the unit is delivered, the VFR button is not assigned a code. This means that if this button is pressed for 0.5 seconds, „—“ is shown in the code display and the transponder then switches back to the previously-active code.

920.1.10 CONFIGURATION MODE

The configuration mode is available from SBY mode only. To get into configuration mode press button **SEL** (G), turn rotary encoder (B) until '**CFG**' appears in the bottom row of the display. Refer to BECKER's Pilot's Guide for available options.

920.2 LIMITATIONS

Not applicable.

920.3 EMERGENCY PROCEDURES

920.3.1 IMPORTANT CODES

7600 Loss of communications.

7500 Hijacking.

7700 Emergency (All secondary surveillance radar sites are ready to receive this code at all times).

See the Airman's Information Manual (AIM) for a detailed explanation of identification codes.

920.4 NORMAL PROCEDURES

Not applicable

920.5 PERFORMANCE

Not applicable
