

---

---

# INFORMATION MANUAL

## *EXTRA 200*

### MANUFACTURER

EXTRA Flugzeugproduktions- und Vertriebs- GmbH  
Flugplatz Dinslaken  
46569 Hünxe, Federal Republic of Germany

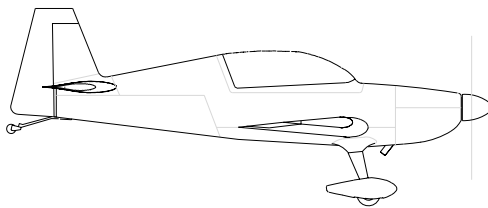

### WARNING

**This is an Information Manual and may be used for general purposes only.**

**This Information Manual is not kept current.**

**It must not be used as a substitute for the official FAA/EASA Approved Pilot's Operating Handbook required for operation of the airplane.**

---

---

**Left blank intentionally**

**MAIN TABLE OF CONTENTS**

<i>Section</i>	<i>Page</i>
0 PUBLICATION GUIDANCE .....	0-1
1 GENERAL .....	1-1
2 LIMITATIONS .....	2-1
3 EMERGENCY PROCEDURES .....	3-1
4 NORMAL PROCEDURES .....	4-1
5 PERFORMANCE .....	5-1
6 WEIGHT AND BALANCE AND EQUIPMENT LIST .....	6-1
7 DESCRIPTION AND OPERATION OF AIRCRAFT AND SYSTEMS .....	7-1
8 HANDLING, SERVICING AND MAINTENANCE .....	8-1
9 SUPPLEMENTS .....	9-1

THIS HANDBOOK SHALL ALWAYS BE CARRIED ON BOARD DURING FLIGHT.

PILOTS OPERATING HANDBOOK PREPARED  
BY:

EXTRA Flugzeugproduktions- und Vertriebs- GmbH

THIS MANUAL IS FURNISHED TO  
THE CIVIL AVIATION AUTHORITIES  
AS A PART OF THE CERTIFICATION-  
MATERIAL FOR THIS MODEL.

---

SECTION 0

PUBLICATION GUIDANCE

Table of Contents

<i>Paragraph</i>		<i>Page</i>
<b>1</b>	<b>INTRODUCTION .....</b>	<b>0-3</b>
<b>2</b>	<b>NOTES .....</b>	<b>0-3</b>
<b>3</b>	<b>WARNINGS, CAUTIONS AND NOTES .....</b>	<b>0-4</b>
<b>4</b>	<b>LOG OF EFFECTIVE PAGES .....</b>	<b>0-5</b>

**Left blank intentionally**

---

## 1 INTRODUCTION

This handbook contains 10 sections, and includes the material required to be furnished to the pilot by FAR Part 23. It also contains supplementary data supplied by EXTRA Flugzeugproduktions- und Vertriebs- GmbH.

## 2 NOTES

- 2.1 This Flight Manual applies only to the aircraft whose nationality and registration marks are noted on the title page.
- 2.2 It is the responsibility of the pilot to be familiar with the contents of this Flight Manual including revisions and any relevant supplements.
- 2.3 Pages of this Airplane Flight Manual must not be exchanged and no alterations of or additions to the approved contents may be made without the EXTRA Flugzeugproduktions- und Vertriebs- GmbH/LBA approval. The editor has the copyright of this Flight Manual and is responsible for edition of revisions/ amendments and supplements.
- 2.4 Amendments, which affect the airworthiness of the aircraft will be announced in the publication Lufttüchtigkeitsanweisung (airworthiness directive) issued by LBA, Luftfahrt-Bundesamt, or by the manufacturer EXTRA Flugzeugproduktions- und Vertriebs- GmbH. The owner is responsible for incorporating prescribed amendments and should make notes about these on the records of amendments.
- 2.5 Should this Flight Manual get lost, inform EXTRA Flugzeugproduktions- und Vertriebs- GmbH, Dinslaken 46569 Hünxe, Federal Republic of Germany.
- 2.6 Should this Flight Manual be found, kindly forward it to the civil board of aviation in the country the aircraft is registered.
- 2.7 This Flight Manual is only valid in connection with the latest, new LBA approved revision.

### 3 WARNINGS, CAUTIONS AND NOTES

The following definitions apply to Warnings, Cautions, and Notes:

**WARNING**

=> Operating procedures, techniques, etc which could result in personal injury or loss of life if not carefully followed

**CAUTION**

=> Operating procedures, techniques, etc , which could result in damage to equipment if not carefully followed.

**NOTE**

=> An operating procedures, technique, etc which is considered essential to emphasize.

"Shall", "Will", "Should" and "May"

The words "Shall" or, "will" shall be used to express a mandatory requirement. The word "should" shall be used to express nonmandatory provisions. The word "may" shall be used to express permissible.

---

**4 LOG OF EFFECTIVE PAGES**

Dates of issue for original and revised pages:	Date and sign of LBA approval:
Original ..... 29. May 1996	LBA approved ..... 12. August 1996
Revision No. 1 ..... 29. November 1996	LBA approved ..... 10. December 1996
Edition No. 2 ..... 20. April 2002	LBA approved ..... 30. October 2002
Rev. No 1, 2nd Ed. .... 28. February 2006	EASA Approval N° ..... EASA.A.A.01278 Date of Approval ..... 05. September 2006
Rev. No 2, 2nd Ed. .... 20. September 2006	EASA Approval N° ..... EASA.A.A.01319 Date of Approval ..... 20. November 2006
Rev. No 3, 2nd Ed. .... 14. July 2008	Approved under the authority of DOA No.: EASA.21J.073 (ECO: AM-300-08-03)

**LOG OF EFFECTIVE PAGES (cont.)**

Page	Date	Page	Date
Title .....	28. February 2006	6-1 thru 6-2 .....	20. April 2002
i .....	20. April 2002	6-3 .....	28. February 2006
ii .....	28. February 2006	6-4 .....	20. April 2002
0-1 thru 0-2 .....	20. April 2002	6-5 .....	28. February 2006
0-3 .....	28. February 2006	6-6 thru 6-9 .....	20. April 2002
0-4 .....	20. April 2002	6-10 thru 6-14 .....	28. February 2006
0-5 thru 0-6 .....	14. July 2008	7-1 .....	28. February 2006
1-1 .....	28. February 2006	7-2 .....	20. April 2002
1-2 .....	20. April 2002	7-3 .....	28. February 2006
1-3 thru 1-5 .....	28. February 2006	7-4 thru 7-9 .....	20. April 2002
1-6 .....	20. April 2002	7-10 .....	28. February 2006
1-7 thru 1-8 .....	14. July 2008	7-11 .....	20. April 2002
2-1 .....	14. July 2008	7-12 thru 7-14 .....	28. February 2006
2-2 .....	20. April 2002	7-15 thru 7-16 .....	20. April 2002
2-3 thru 2-4 .....	14. July 2008	8-1 thru 8-4 .....	20. April 2002
2-5 .....	28. February 2006	9-1 .....	28. February 2006
2-6 .....	20. April 2002	9-2 .....	20. April 2002
2-7 .....	14. July 2008	9-3 .....	28. February 2006
2-8 .....	20. September 2006	9-4 .....	20. April 2002
2-9 .....	14. July 2008	9.2-1 thru 9.2-10 (SN 1-2 only) .....	20. April 2002
2-10 .....	28. February 2006	901-1 thru 901-4 .....	20. April 2002
2-11 thru 2-16 .....	14. July 2008	902 .....	reserved
3-1 thru 3-3 .....	20. April 2002	903-1 thru 903-10 .....	20. April 2002
3-4 thru 3-5 .....	14. July 2008	904-1 thru 904-6 .....	20. April 2002
3-6 .....	20. April 2002	905-1 thru 905-2 .....	20. April 2002
3-7 .....	14. July 2008	905-3 thru 905-4 .....	28. February 2006
3-8 .....	20. April 2002	905-5 thru 905-6 .....	20. April 2002
4-1 .....	28. February 2006	906-1 thru 906-6 .....	20. April 2002
4-2 .....	20. April 2002	907-1 thru 907-3 .....	20. April 2002
4-3 .....	14. July 2008	907-4 .....	14. July 2008
4-4 thru 4-6 .....	20. April 2002	907-5 thru 907-6 .....	20. April 2002
4-7 .....	14. July 2008	908-1 thru 908-2 .....	20. April 2002
4-8 .....	28. February 2006	908-3 thru 908-5 .....	14. July 2008
4-9 .....	14. July 2008	908-6 .....	20. April 2002
4-10 .....	20. April 2002	909 thru 910 .....	reserved
4-11 .....	14. July 2008	911-1 thru 911-4 .....	20. April 2002
4-12 .....	20. April 2002	912-1 thru 912-8 .....	28. February 2006
5-1 thru 5-3 .....	20. April 2002	913-1 thru 913-8 .....	28. February 2006
5-4 .....	14. July 2008	914-1 thru 914-6 .....	28. February 2006
5-5 .....	20. April 2002	915-1 thru 915-8 .....	28. February 2006
5-6 thru 5-9 .....	14. July 2008	916-1 thru 916-6 .....	28. February 2006
5-10 thru 5-11 .....	20. April 2002	917-1 thru 917-8 .....	28. February 2006
5-12 .....	14. July 2008	918-1 thru 918-6 .....	28. February 2006
5-13 thru 5-14 .....	20. April 2002	919-1 thru 919-8 .....	28. February 2006
5-15 thru 5-16 .....	14. July 2008	920-1 thru 920-10 .....	28. February 2006

---

---

SECTION 1

GENERAL

**Table of Contents**

<i>Paragraph</i>		<i>Page</i>
<b>1.0</b>	<b>DESCRIPTION .....</b>	<b>1-3</b>
<b>1.1</b>	<b>SPECIFICATION OF CLASS .....</b>	<b>1-3</b>
<b>1.2</b>	<b>MANUFACTURER .....</b>	<b>1-3</b>
<b>1.3</b>	<b>TECHNICAL DATA .....</b>	<b>1-3</b>
1.3.1	3-View Drawing .....	1-3
1.3.2	Main Data .....	1-4
1.3.3	Wing .....	1-4
1.3.4	Horizontal Tail .....	1-4
1.3.5	Elevator .....	1-4
1.3.6	Vertical Tail .....	1-4
1.3.7	Rudder .....	1-4
<b>1.4</b>	<b>ENGINE .....</b>	<b>1-5</b>
<b>1.5</b>	<b>PROPELLER .....</b>	<b>1-5</b>
1.5.1	Exhaust Systems (optional) .....	1-5
<b>1.6</b>	<b>FUEL .....</b>	<b>1-5</b>
<b>1.7</b>	<b>OIL .....</b>	<b>1-5</b>
<b>1.8</b>	<b>LOADING .....</b>	<b>1-6</b>
<b>1.9</b>	<b>TERMINOLOGY .....</b>	<b>1-6</b>
<b>1.10</b>	<b>SECONDARY TERMINOLOGY .....</b>	<b>1-7</b>

**Left blank intentionally**

## 1.0 DESCRIPTION

This description belongs to aircraft type EXTRA 200 with nationality and registration marks:



### Manufacturing

The airframe is built of tig-welded steel-tube construction. Wings, rudder and landing gear are manufactured of composite material.

The aircraft is a two-seater with the rear seat instrumented for pilot in command.

## 1.1 SPECIFICATION OF CLASS

The aircraft is certified in normal and acrobatic category. LBA - Certificate No. 1086.

## 1.2 MANUFACTURER

Manufacturer EXTRA Flugzeugproduktions- und Vertriebs- GmbH, Flugplatz Dinslaken, 46569 Hünxe, Federal Republic of Germany.

## 1.3 TECHNICAL DATA

### 1.3.1 3-VIEW DRAWING

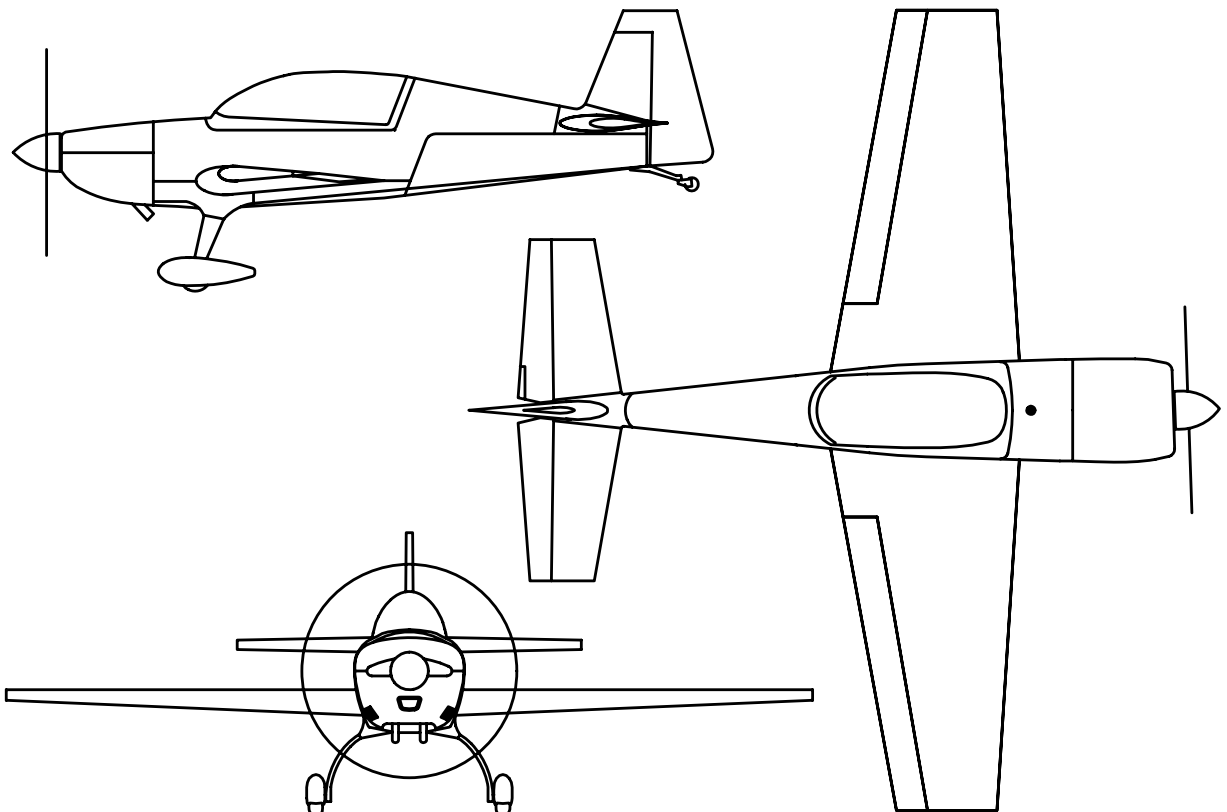

---

---

### 1.3.2 MAIN DATA

- Length	6,51 m (22,25 ft)
- Height	2,67m ( 8,76 ft)
- Span	7.50 m (24.61 ft)
- Wheelbase	1,80 m ( 5,91 ft)
- Wheel-track	4.91 m (16.10 ft)

### 1.3.3 WING

- Wing span	7.5 m (24.61 ft)
- Wing-area	10,44 m <sup>2</sup> (111.6 ft <sup>2</sup> )
- Airfoil	Root: MA 15 S. Tip, MA 12 S
- Chord	Root: 1,85 m. Tip, 0,93m
- MAC	1,39 m ( 4,56 ft)
- Aileron area	2 x 0,855 m <sup>2</sup> (2 x 9,20 ft <sup>2</sup> )
- Aileron deflection	up 30°, down 30°, tolerance -2°

### 1.3.4 HORIZONTAL TAIL

- Span	3,20 m (10,50 ft)
- Area	2,56 m <sup>2</sup> (27.56 ft <sup>2</sup> )
- Airfoil	Wortmann FX 71-L-150/30

### 1.3.5 ELEVATOR

- Area	0,77 m <sup>2</sup> (8,29 ft <sup>2</sup> )
- Elevator-deflection	up 22°; down 22°; tolerance -2°
- Trim-tab-deflection	> 15°,

### 1.3.6 VERTICAL TAIL

- Area	1,39 m <sup>2</sup> (14,96 ft <sup>2</sup> )
- Airfoil	Wortmann FX 71-L-150/30

### 1.3.7 RUDDER

- Area	0,51 m <sup>2</sup> ( 5,49 ft <sup>2</sup> )
- Rudder deflection	left 30°; right 30°; tolerance -2°

**1.4 ENGINE**

Manufacturer: Textron-Lycoming Williamsport Plant PA 17701 USA.

Type: Textron Lycoming AEIO-360-A1E

Max. Takeoff Power: 200 HP @ 2700 RPM with full throttle in MSL  
 Max. Continuous Power 185 HP @ 2500 RPM with full throttle in MSL

**1.5 PROPELLER**

Manufacturer: MT-Propeller Entwicklung GmbH, Federal Republic of Germany.

Type: MTV-12-B-C/C183-17e 3-blade constant speed.

**1.5.1 EXHAUST SYSTEMS (OPTIONAL)**

Manufacturer: Gomolzig Flugzeug- und Maschinenbau GmbH, Federal Republic of Germany

Exhaust Silencer for Standard System: PN: EA 200-606000

Complete 4 in 1 System with integrated Silencer: PN: EA 200-606000/1

**1.6 FUEL**

Fuel type AVGAS 100/100 LL (for alternate fuel grades see latest issue of Textron Lycoming S.I. No 1070)

**Total fuel capacity:** 122 liters (32.1 US Gallon)  
 - Wingtanks (2 x 43 l) 86 liters (22.6 US Gallon)  
 - Acro tank 36 liters (9.5 US Gallon)

**Usable fuel capacity:** 117 L (30.8 US Gallon)  
 - Wingtanks: 85 L (22.4 US Gallon)  
 - Acro tank : 32 L (8.5 US Gallon)

**1.7 OIL**

Sump capacity: 8 qts.  
 Minimum capacity for acro: 6 qts  
 Normal: 4 qts.

Average ambient air temperature	Mil-L6082 grades	Mil-22851 ashless dispersant grades
All temperatures	----	SAE 15W50 or 20W50
> 27°C (80°F)	SAE 60	SAE 60
> 16°C (60°F)	SAE 50	SAE 40 or 60
- 1°C till 32°C SAE 40 (30°F - 90°F)	SAE 40	

**1.7 OIL (Cont.)**

Average ambient air temperature	Mil-L6082 grades	Mil-22851 ashless dispersant grades
- 18°C till 21°C (0°F - 70°F)	SAE 30	SAE 30, 40 or 20W40
- 18°C till 32°C (0°F - 90°F)	SAE 20W50	SAE 20W50 or 15W50
< -12°C (10°F)	SAE 20	SAE 30 or 20W30

(single or multi - viscosity aviation grade oils see latest issue of Textron Lyc. S.I. No. 1014)

**1.8 LOADING**

Wing loading	80.5 kg/m <sup>2</sup> 67.0 / 76.6 kg/m <sup>2</sup>	Normal Acrobatic ( 1 seat / 2 seats )
Power loading	4.2 kg/hp 3.5 / 4.0 kg/hp	Normal Acrobatic ( 1 seat / 2 seats )

**1.9 TERMINOLOGY**

**Air Speeds**

CAS	Calibrated Air Speed. CAS is the same as TAS (True Air Speed) in standard atmospheric condition at sea level
KCAS	Calibrated speed in knots
GS	Ground speed
IAS	Indicated air speed
KIAS	Indicated speed in knots
TAS	True air speed. It's the same as CAS compensated for altitude, temperature and density
V <sub>A</sub>	Maneuvering speed
V <sub>NE</sub>	Never exceed speed
V <sub>NO</sub>	Maximum structural cruising speed
V <sub>S</sub>	Stalling speed or minimum steady flight speed
V <sub>X</sub>	Best angle-of-climb speed
V <sub>Y</sub>	Best rate-of-climb speed

---

---

**Meteorological terminology**

ISA	International standard atmospheric condition
OAT	Outside air temperature

**1.10 SECONDARY TERMINOLOGY**

FPM	Feet/minute
ft	Feet = 0.3048 m
inch	inch = 2.54 cm
m	Meter
L	Liters
Gal	US gallon = 3.79 liters
Qts	US quart = 0.946 liters
hp	Horse power (english)
h	Hour
kts	Knots (NM/h) = 1.852 kilometer per hour
km/h	kilometer per hour
Lbs	English pound = 0.4536 kg
hPA	hekto Pascal
IN HG	Inches of mercury
MP	Manifold pressure
PA	Pressure altitude (ft)
NM	Nautical miles = 1.852 km
RPM	Revolutions per minute
C.G.	Center of gravity
Arm	Arm is the horizontal distance from reference datum
Moment	is the product of weight of an item multiplied by its arm.

**1.11 CONVERSION TABLE**

knots <> km/h		km/h <> knots		ft <> m		m <> ft		NM <> km		km <> NM	
60	111	100	54	500	152	250	820	10	19	10	5
65	120	110	59	1000	305	375	1230	20	37	20	11
70	130	120	65	1500	457	500	1640	30	56	30	16
75	139	130	70	2000	610	625	2051	40	74	40	22
80	148	140	76	2500	762	750	2461	50	93	50	27
85	157	150	81	3000	914	875	2871	60	111	60	32
90	167	160	86	3500	1067	1000	3281	70	130	70	38
95	176	170	92	4000	1219	1125	3691	80	148	80	43
100	185	180	97	4500	1372	1250	4101	90	167	90	49
105	194	190	103	5000	1524	1375	4511	100	185	100	54
110	204	200	108	5500	1676	1500	4921	110	204	110	59
115	213	210	113	6000	1829	1625	5331	120	222	120	65
120	222	220	119	6500	1981	1750	5741	130	241	130	70
125	232	230	124	7000	2134	1875	6152	140	259	140	76
130	241	240	130	7500	2286	2000	6562	150	278	150	81
135	250	250	135	8000	2438	2125	6972	160	296	160	86
140	259	260	140	8500	2591	2250	7382	170	315	170	92
145	269	270	146	9000	2743	2375	7792	180	333	180	97
150	278	280	151	9500	2896	2500	8202	190	352	190	103
155	287	290	157	10000	3048	2625	8612	200	370	200	108
160	296	300	162	10500	3200	2750	9022	220	407	250	135
165	306	310	167	11000	3353	2875	9432	240	444	300	162
170	315	320	173	11500	3505	3000	9843	260	482	350	189
175	324	330	178	12000	3658	3125	10253	280	519	400	216
180	333	340	184	12500	3810	3250	10663	300	556	450	243
185	343	350	189	13000	3962	3375	11073	320	593	500	270
190	352	360	194	13500	4115	3500	11483	340	630	550	297
195	361	370	200	14000	4267	3625	11893	360	667	600	324
200	370	380	205	14500	4420	3750	12303	380	704	650	351
205	380	390	211	15000	4572	3875	12713	400	741	700	378
210	389	400	216	15500	4724	4000	13123	420	778	750	405
215	398	410	221	16000	4877	4125	13533	440	815	800	432
220	407	420	227	16500	5029	4250	13944	460	852	850	459
225	417	430	232	17000	5182	4375	14354	480	889	900	486
230	426	440	238	17500	5334	4500	14764	500	926	950	513
235	435	450	243	18000	5486	4625	15174	520	963	1000	540

---

---

SECTION 2

LIMITATIONS

**Table of Contents**

<i>Paragraph</i>		<i>Page</i>
<b>2.1</b>	<b>GENERAL .....</b>	<b>2-3</b>
<b>2.2</b>	<b>AIR SPEED (IAS) .....</b>	<b>2-3</b>
<b>2.3</b>	<b>CROSSWIND COMPONENT .....</b>	<b>2-3</b>
<b>2.4</b>	<b>ENGINE .....</b>	<b>2-3</b>
2.4.1	Fuel .....	2-4
2.4.2	Engine Limitations .....	2-4
<b>2.5</b>	<b>PROPELLER .....</b>	<b>2-5</b>
<b>2.6</b>	<b>WEIGHT LIMITS .....</b>	<b>2-5</b>
<b>2.7</b>	<b>WEIGHT AND C.G. ENVELOPE .....</b>	<b>2-5</b>
2.7.1	Normal Flight .....	2-5
2.7.2	Acrobatic Flight (1 Seat) .....	2-5
2.7.3	Acrobatic Flight (2 Seats) .....	2-5
<b>2.8</b>	<b>ACROBATIC MANEUVERS .....</b>	<b>2-6</b>
2.8.1	Normal Flight .....	2-6
2.8.2	Acrobatic Flight .....	2-6
<b>2.9</b>	<b>LOAD FACTOR .....</b>	<b>2-7</b>
2.9.1	Normal Flight .....	2-7
2.9.2	Acrobatic Flight .....	2-8
<b>2.10</b>	<b>FLIGHT CREW LIMITS .....</b>	<b>2-8</b>
<b>2.11</b>	<b>KINDS OF OPERATIONAL LIMITS .....</b>	<b>2-8</b>
2.11.1	Structural Temperature/Colour Limitation .....	2-8
<b>2.12</b>	<b>MAXIMUM OPERATING ALTITUDE .....</b>	<b>2-8</b>
<b>2.13</b>	<b>TIRE PRESSURE .....</b>	<b>2-8</b>
<b>2.14</b>	<b>MARKINGS AND PLACARDS .....</b>	<b>2-8</b>
2.14.1	Aircraft Identity Placard .....	2-8
2.14.2	Operating Placards .....	2-9
2.14.3	Instrument Markings .....	2-14
<b>2.15</b>	<b>KINDS OF OPERATION EQUIPMENT LIST .....</b>	<b>2-15</b>
<b>2.16</b>	<b>NOISE LEVEL .....</b>	<b>2-16</b>

**Left blank intentionally**

**SECTION 2**

**LIMITATIONS**

**2.1 GENERAL**

This section includes operating limitations, instrument markings, and basic placards necessary for the safe operation of the aircraft, its engine, standard systems, and standard equipment. The limitations included in this section have been approved by the Luftfahrt-Bundesamt (LBA). Observance of these operating limitations is required by national aviation regulations.

**NOTE**

In case of an aircraft equipped with specific options additional information required for safe operation will be contained in Section 9 "Supplements".

Instrument markings and placards are provided for the acrobatic category only; for normal category refer to corresponding limitations. This aircraft is certified under LBA-Flugzeugkennblatt No. 1086, Type Certification Data Sheet (T.C.D.S.).

Any exceeding of given limitations have to be reported by the pilot and considered by corresponding maintenance or inspection procedure according to the *SERVICE MANUAL*.

**2.2 AIR SPEED (IAS)**

Never Exceed Speed	$V_{NE}$	217 KIAS	(402 km/h)
Max. Structural Cruising Speed	$V_{NO}$	154 KIAS	(285 km/h)
Maneuver Speed (Normal Cat.)	$V_A$	138 KIAS	(256 km/h)
Maneuver Speed (Acro I , Acro II)	$V_A$	154 KIAS	(285 km/h)

**2.3 CROSSWIND COMPONENT**

Max. demonstrated crosswind component for takeoff and landing 15 knots (27 km/h).

**2.4 ENGINE**

Engine-type: Textron-Lycoming AEIO-360-A1E with

Max. Takeoff Power: 200 HP @ 2700 RPM with full throttle in MSL

Max. Continuous Power 185 HP @ 2500 RPM with full throttle in MSL

**2.4.1 FUEL**

Minimum grade aviation gasoline : 100/100LL; for alternate fuelgrades see latest revision of Lyc. S.I. No. 1070

Total fuel capacity: 122 litres (32.1 US Gallon)

Usable fuel capacity: 117 litres (30.8 US Gallon)

For acrobatic flight wing tanks must be empty.

Total fuel capacity for acrobatic 36 litres (9.5 US Gallon) in acro tank.

Usable fuel capacity for acrobatic 32 litres (8.5 US Gallon) in acro tank.

**2.4.2 ENGINE LIMITATIONS**

**a) Power in MSL**

-Max. Takeoff Power: 200 HP @ 2700 RPM with full throttle

-Max. Continuous Power: 185 HP @ 2500 RPM with full throttle

**b) Oil-temperature gauge**

-Max 118°C 245°F

**c) Oil capacity**

-Maximum sump capacity: 8 qts.

-Minimum sump capacity: -Acrobatic: 6 qts.

-Normal: 4 qts.

**d) Oil pressure**

-Minimum Idling 172 kPa 25 Psi

-Normal 414 - 621 kPa 60 - 90 Psi

-Starting, Warm up,  
Taxi and Takeoff 379 - 689 kPa 55-100 Psi

**CAUTION**

It is normal for the oil pressure to "flicker" from 10 to 30 psi (69 to 207 kPa) when going from upright to inverted flight. During knife edge flights and zero-g flights oil pressure may drop and the oil system may not scavenge resulting in engine failure or damage if flight is prolonged. Knife edge and zero-g flight should not exceed 10 seconds.

**WARNING**

If oil pressure drops to 0 psi the propeller pitch changes automatically to coarse (high) pitch with a corresponding decrease in RPM. Apply positive g to avoid engine stoppage.

**e) Fuel pressure**

- Max. 83 kPa 12 Psi

**f) Cylinder head temperature**

- Max 260°C 500°F

## 2.5 PROPELLER

MT-Propeller Entwicklung GmbH, Federal Republic of Germany

Type: MTV-12-B-C/C183-17e

Max. Takeoff RPM:	2700
Max. Continuous RPM:	2500

## 2.6 WEIGHT LIMITS

Max. allowed <b>empty</b> weight:	
-Normal category	646 kg (1424lbs)
-Acrobatic category ( 1 seat)	591 kg (1302lbs)
( 2 seats)	606 kg (1335lbs)
Max. allowed <b>T/O</b> weight:	
-Normal category	840 kg (1858 lbs)
-Acrobatic category ( 1 seat)	700 kg (1549 lbs)
( 2 seats)	800 kg (1770 lbs)
Max. allowed <b>landing</b> weight:	840 kg (1858 lbs)

## 2.7 WEIGHT AND C.G. ENVELOPE

Vertical reference = firewall.  
Horizontal reference = upper longerons in cockpit.

### 2.7.1 NORMAL FLIGHT

Max T/O Weight:	forward C.G.	rear C.G.
840 kg (1858 lbs) (and below)	73,2 cm (28,8")	89.1 cm (35.0")

### 2.7.2 ACROBATIC FLIGHT (1 SEAT)

Max T/O Weight:	forward C.G.	rear C.G.
700 kg (1549 lbs) (and below)	73,2 cm (28,8")	89.1 cm (35.0")

### 2.7.3 ACROBATIC FLIGHT (2 SEATS)

Max T/O Weight:	forward C.G.	rear C.G.
800 kg (1770 lbs) (and below)	73,2 cm (28,8")	89.1 cm (35.0")

## **2.8 ACROBATIC MANEUVERS**

### **2.8.1 NORMAL FLIGHT**

All acrobatic maneuvers are prohibited except stall, chandelle, lazy eight and turns up to 60 degrees bank angle.

### **2.8.2 ACROBATIC FLIGHT**

The plane is designed for unlimited acrobatics within the approved operating limitations. Inverted flight manoeuvres are limited to max 4 min. Recommended basic maneuver entry speeds are listed in the following list.

<b>NOTE</b>
-------------

If acrobatic maneuvers will be performed with copilot or passenger, the pilot has to check and attend the physiological capability before and during acrobatic maneuvers due to the high possible g-loads.

Check weight and C.G.position !

Maneuvers	Recommended entry speeds IAS		Symbol	Remarks
	min knots (km/h)	max knots (km/h)		
Segment:				
horizontal Line	$V_s$	$V_{NE}$		
45° climbing	80 (148)	$V_{NE}$		
90° up	$V_A$	$V_{NE}$		
45° diving	$V_s$	$< V_{NE}$		reduce throttle
90° diving	$V_s$	$< V_{NE}$		reduce throttle
1/4 Loop climb.	100 (185)	185 (343)		
Looping	100 (185)	185 (343)		
Stall turn	100 (185)	185 (343)		
Aileron roll	80 (148)	$V_A$		full deflection
Snap roll	80 (148)	135 (250)		
"tail slide"	100 (185)	185 (343)		
Spin	$V_s$			
Inverted Spin	$V_s$			
Knife edge	$>150$ (278)			$< 10$ s
Inverted Flight	$>V_s$	185 (343)		$< 4$ min

**CAUTION**

Particular caution must be exercised when performing maneuvers at speeds above  $V_A$  [154 KIAS (285 km/h)]. Large or abrupt control inputs above this speed may impose unacceptably high loads which exceed the structural capability of the aircraft.

**NOTE**

For Acrobatic Maneuvers see Section 4. All maneuvers can be performed in upright and inverted flight attitude.

**2.9 LOAD FACTOR**

**2.9.1 NORMAL FLIGHT**

+ 6 g / - 3 g for MTOW: 840 kg (1852 lbs)

## 2.9.2 ACROBATIC FLIGHT

+ 10 g / - 10 g for 1 seat occupied (MTOW 700 kg / 1543 lbs)  
 + 8 g / - 8 g for 2 seat occupied (MTOW 800 kg / 1763 lbs)

## 2.10 FLIGHT CREW LIMITS

Minimum crew is one pilot in the rear seat. 2 persons in both categories (Normal and Acrobatic). Pilot in command seat is the rear seat, Copilot or passenger seat is the front seat. Noise optimized headsets are required.

## 2.11 KINDS OF OPERATIONAL LIMITS

Only **VFR flights at day** are allowed. The A/C engine may be started on ground at OAT from -20°C (-4°F) to +44°C (+111°F). Below temperatures of -10°C (+14°F) the oil vent line must be modified by the low temperature kit (breather line). Flight in known icing-conditions is prohibited. Smoking is prohibited.

### 2.11.1 STRUCTURAL TEMPERATURE/COLOUR LIMITATION

Structure is qualified up to 72°C (161.6°F). Structure temperatures (composite) above 72°C (161.6°F) are not permitted. Not to exceed this temperature limit, colour specification for composite structure (manufacturer document EA-03205.19) has to be complied with.

To check the temperature inside the cockpit (potential "green house" effect) a reversible temperature indicator (*STRUCTURAL OVERHEAT INDICATOR*) is applied on the root rib of the right wing. After reaching the temperature limit of 72°C (161,6°F) the word "*RISK*" appears and flying is prohibited.



## 2.12 MAXIMUM OPERATING ALTITUDE

Max. certified operating altitude is 16000 ft MSL (4877 m)

## 2.13 TIRE PRESSURE

The tire pressure is 2,6 bar (37,7 Psi).

## 2.14 MARKINGS AND PLACARDS

### 2.14.1 AIRCRAFT IDENTITY PLACARD

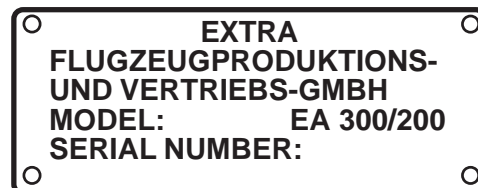
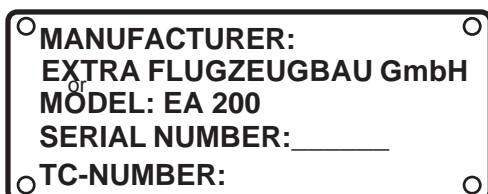

2.14.2 OPERATING PLACARDS

$V_A = 154$  KIAS (Acro)  
 $V_A = 138$  KIAS (Normal)

or

$V_A = 285$  km/h (Acro)  
 $V_A = 256$  km/h (Normal)

— (near airspeed indicator)

THE MARKINGS AND PLACARDS INSTALLED IN THIS AIRPLANE CONTAIN OPERATING LIMITATIONS WHICH MUST BE COMPLIED WITH WHEN OPERATING THIS AIRPLANE IN THE ACROBATIC CATEGORY. OTHER LIMITATIONS WHICH MUST BE COMPLIED WITH WHEN OPERATING THIS AIRPLANE IN THIS CATEGORY OR IN THE NORMAL CATEGORY ARE CONTAINED IN THE AIRPLANE FLIGHT MANUAL. APPLICABLE RPM LIMITATION MUST BE OBSERVED.

— (in the rear cockpit)

THIS AIRPLANE IS CERTIFICATED FOR VFR, DAY OPERATION. OPERATION IN KNOWN ICING CONDITIONS IS PROHIBITED.

— (on the rear instrument panel)

FUEL  
AVGAS 100/100 LL

— (near each filler cap)

OIL

— (on the separate hatch / upper cowling)

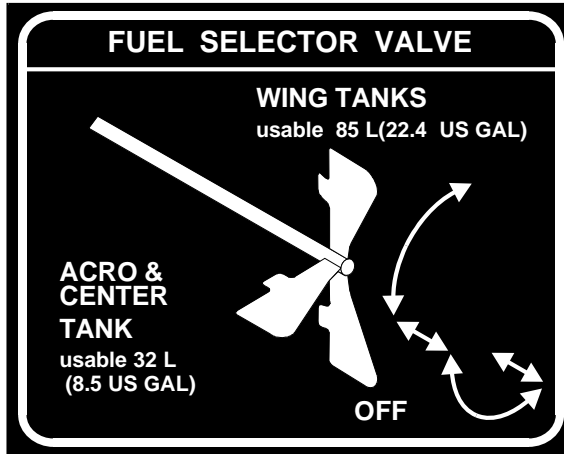

— (in both cockpits near selector valve handle)

NOSE DOWN <= NEUTRAL=> NOSE UP  
TRIM

— (near the handle at the right side in the rear cockpit)

WING TANK  
MUST BE EMPTY FOR ACROBATICS

— (on the rear instrument panel under the fuel capacity indicators)

ACRO & CENTER TANK  
WHEN THE INDICATOR READS "ZERO" IN LEVEL FLIGHT THE REMAINING USABLE FUEL IS 8 LITERS (2 US GAL.)

**ACROBATIC: ± 10 G, 1 PILOT**      **± 8 G, 2 PERSON ON BOARD**  
**MTOW: 700 KG (1543 LBS)**   **MTOW: 800 KG (1763 LBS)**

**NORMAL: + 6 G/ -3 G; MTOW: 840 KG (1852 LBS)**  
**ACROBATICS INCL. SPIN NOT APPROVED**

(in both cockpits)

**AUXILIARY FUEL PUMP**

**ON                  OFF**

(near pump-switch on the instrument panel  
in the rear cockpit)

**NO SMOKING**

(in both cockpits)

**USE OF HEADSET IS REQUIRED**  
**USE OF PARACHUTE IS RECOMMENDED**

(on the right side of both  
instrument panels)

**MAGNETIC  
DIRECTION INDICATOR  
CALIBRATION**

(near Mag. Dir. Indicator)

**LOW RPM    <= PROP =>    HIGH RPM**

(on RPM control unit in the  
rear cockpit)

**LEAN            <= MIXTURE =>            RICH**

(on mixture control unit in the  
rear cockpit)

**CLOSE    <= THROTTLE =>    OPEN**

(near throttle control in both  
cockpits)

**LOCK            <= CANOPY =>            UNLOCK**

(near canopy locking handles  
of each cockpit)

**VENT  
OPEN**

(near the eyeball-  
type adjustable vents)

**PITOT-STATIC  
DRAIN**

(near the drain-point)

**APPROVED ACROBATIC MANEUVERS  
AND RECOMMENDED ENTRY AIRSPEEDS**

MANEUVERS	SPEEDS	
	min KIAS	max KIAS
Segment: horizontal Line	$V_S$	$V_{NE}$
45° climbing	80	$V_{NE}$
90° up	$V_A$	$V_{NE}$
45° diving	$V_S$	$<V_{NE}$
90° diving	$V_S$	$<V_{NE}$
1/4 Loop climb.	100	185
Loop	100	185
Stall turn	100	185
Aileron roll	80	$V_A$
Snap roll	80	138
"Tail-slide"	100	185
Spin	$V_S$	
Inverted spin	$V_S$	
Inverted flight Less than 4 min	$> V_S$	185
Knife edge Less than 10 s	$>150$	

(in both cockpits)  
(alternative SI units  
next page)

**CAUTION**

Particular caution must be exercised when performing maneuvers at speeds above  $V_A$  (154 KIAS). Large or abrupt control inputs above this speed may impose unacceptably high loads which exceed the structural

**WARNING:**  
**SOLO FLYING FROM  
REAR SEAT ONLY!**

(on front instrument panel)

**APPROVED ACROBATIC MANEUVERS  
AND RECOMMENDED ENTRY AIRSPEEDS**

MANEUVERS	AIRSPEEDS	
	min km/h	max km/h
<b>Segment:</b>		
horizontal Line	$V_S$	$V_{NE}$
45° climbing	148	$V_{NE}$
90° up	$V_A$	$V_{NE}$
45° diving	$V_S$	$<V_{NE}$
90° diving	$V_S$	$<V_{NE}$
1/4 Loop climb.	185	343
Loop	185	343
Stall turn	185	343
Aileron roll	148	$V_A$
Snap roll	148	256
"Tail-slide"	185	343
Spin	$V_S$	
Inverted spin	$V_S$	
Inverted flight Less than 4 min	$> V_S$	343
Knife edge Less than 10 s	$>278$	

(in both cockpits)  
(alternative US units  
previous page)

**CAUTION**

Particular caution must be exercised when performing maneuvers at speeds above  $V_A$  (285 km/h). Large or abrupt control inputs above this speed may impose unacceptably high loads which exceed the structural

**Left blank intentionally**

**2.14.3 INSTRUMENT MARKINGS**

AIRSPEED INDICATOR

green arc	60 KIAS (111 km/h) - 154 KIAS (285 km/h)
yellow arc	154 KIAS (285 km/h) - 217 KIAS (402 km/h)
red line	217 KIAS (402 km/h)

OIL PRESSURE INDICATOR

red line	25 Psi (172 kPa)
yellow arc	25 Psi (172 kPa) - 55 Psi (379 kPa)
green arc	55 Psi (379 kPa) - 90 Psi (621 kPa)
yellow arc	90 Psi (621 kPa) - 100Psi (689 kPa)
red line	100 Psi (689 kPa)

OIL TEMPERATURE INDICATOR

yellow arc	<140°F
green arc	140°F - 210°F
yellow arc	210°F - 245°F
red line	245°F

CYLINDERHEAD TEMPERATURE INDICATOR

yellow arc	<150°F
green arc	150°F - 400°F
yellow arc	400°F - 500°F
red line	500°F

RPM INDICATOR

green arc	700 - 2500 RPM
yellow arc	2500 - 2700 RPM
red line	2700 RPM

G - METER

green arc	- 5 g - + 8 g
yellow arc	+ 8 g - + 10 g
red line	+ 10 g

FUEL PRESSURE INDICATOR

red line	0 PSI
green arc	0 PSI - 12 PSI
red line	12 PSI

FUEL CAPACITY INDICATOR "WING TANK"

red line	0
----------	---

FUEL CAPACITY INDICATOR "ACRO & CENTER TANK"

yellow line	0
red line *	0

**NOTE**

When the Fuel Capacity Indicator "ACRO & CENTER TANK" reads "ZERO" in level flight the remaining usable fuel is 8 Liters (2 US GAL.)

\* For the US. registered aircrafts only

**2.15 KINDS OF OPERATION EQUIPMENT LIST**

The aircraft may be operated in day VFR when the appropriate equipment is installed and operable. Flying under icing conditions is prohibited.

The following equipment list identifies the systems and equipment upon which type certification for each kind of operation was predicated. The following systems and items of equipment must be installed and operable for the particular kind of operation indicated.

	NORMAL	ACROBATIC	
		1 seat	2 seats
<b>COMMUNICATION</b>			
1. Transceiver-VHF	1	1	1
<b>ELECTRICAL POWER</b>			
1. Battery	1	1	1
2. Alternator	1	1	1
3. Ammeter	1	1	1
<b>FLIGHT CONTROL SYSTEM</b>			
1. Elevator-trim control	1	1	1
2. Stall warning	1	1	1
<b>FUEL</b>			
1. Boost pump	1	1	1
2. Fuel quantity indicator	2	2	2
3. Manifold pressure	1	1	1
4. Fuel flow indicator	0	0	0
5. Fuel pressure	1	1	1
<b>LIGHT</b>			
1. single strobe light	1	1	1
2. Wing-tip position / strobe light	0	0	0
<b>NAVIGATION</b>			
1. Altimeter	1	1	1
2. Airspeed indicator	1	1	1
3. Mag. direction indicator	1	1	1
4. OAT indicator	0	0	0
5. Vertical speed indicator	0	0	0
6. Turn and bank indicator	0	0	0
7. Artificial horizon	0	0	0
8. Directional gyro	0	0	0
9. Transponder <sup>1</sup>	1	1	1

<sup>1</sup>) In some airspaces Mode S Elementary Surveillance functionality is required

	NORMAL	ACROBATIC	
		1 seat	2 seats
<b>ENGINE CONTROL</b>			
1. RPM indicator	1	1	1
2. Exhaust gas temperature ind. (EGT)	0	0	0
3. Cylinder head temperature ind.	0	0	0
<b>OIL</b>			
1. Oil temperature indicator	1	1	1
2. Oil pressure indicator	1	1	1
<b>FLIGHT CREW EQUIPMENT</b>			
1. Parachute rear	0	*	*
2. Parachute front	0	0	*
3. Seat belt rear	1	1	1
4. Seat belt front	1	0	1
5. Headset rear	1	1	1
6. Headset front	1	0	1

**NOTE**

The zeros ( 0 ) used in the above list mean that the equipment and/or system was not required for type certification for that kind of operation.

The asterisks ( \* ) used in the above list mean that latest national aviation regulations must be observed in determining whether the equipment and/or system are required. According FAR Part 91 „General Operating and Flight Rules" each occupant of an US registered airplane must wear an approved parachute when performing acrobatic maneuvers.

Extra Flugzeugproduktions- und Vertriebs- GmbH considers acrobatics without wearing an approved parachute to be unsafe.

**2.16 NOISE LEVEL**

The noise level with standard silencer has been established in accordance

- a) with FAR 36 Appendix G, as 68,4 dB(A).
- b) with ICAO Annex 16, as 73,1 dB(A).

No determination has been made by the LBA for the FAA that the noise levels of this airplane are or should be acceptable or unacceptable for operation at, into, or out, any airport.

---

---

SECTION 3

EMERGENCY PROCEDURES

**Table of Contents**

<i>Paragraph</i>		<i>Page</i>
<b>3.0</b>	<b>INTRODUCTION .....</b>	<b>3-3</b>
3.0.1	General .....	3-3
3.0.2	General Behaviour in Emergency Situations .....	3-3
<b>3.1</b>	<b>AIRSPEEDS FOR EMERGENCY OPERATION .....</b>	<b>3-4</b>
<b>3.2</b>	<b>OPERATIONAL CHECKLIST .....</b>	<b>3-4</b>
3.2.1	Engine Failure During Takeoff Roll .....	3-4
3.2.2	Engine Failure Immediately After Takeoff .....	3-4
3.2.3	Engine Failure During Flight (Restart Process) .....	3-4
3.2.4	Oil System Malfunction .....	3-5
3.2.5	Alternator Failure .....	3-5
<b>3.3</b>	<b>FORCED LANDINGS .....</b>	<b>3-5</b>
3.3.1	Emergency Landing Without Engine Power .....	3-5
3.3.2	Precautionary Landing With Engine Power .....	3-5
<b>3.4</b>	<b>FIRES .....</b>	<b>3-6</b>
3.4.1	During Start On Ground .....	3-6
3.4.2	If Engine Fails to Start .....	3-6
3.4.3	Engine Fire In Flight .....	3-7
<b>3.5</b>	<b>ICING .....</b>	<b>3-7</b>
3.5.1	Inadvertent Icing Encounter .....	3-7
<b>3.6</b>	<b>UNINTENTIONAL SPIN .....</b>	<b>3-7</b>
<b>3.7</b>	<b>MANUAL BAIL-OUT .....</b>	<b>3-7</b>
<b>3.8</b>	<b>EMERGENCY EXIT AFTER TURN OVER .....</b>	<b>3-8</b>
<b>3.9</b>	<b>ELEVATOR CONTROL FAILURE .....</b>	<b>3-8</b>

**Left blank intentionally**

## SECTION 3

### EMERGENCY PROCEDURES

#### 3.0 INTRODUCTION

##### 3.0.1 GENERAL

This section contains the checklist and procedures coping with emergencies that may occur. This checklist must be followed in various emergencies to ensure maximum safety for the crew and/or aircraft.

Thorough knowledge of these procedures will enable the aircrew to better cope with an emergency. The steps should be performed in the listed sequence. However the procedures do not restrict the aircrew from taking any additional action necessary to deal with the emergency. The procedures contain items classified as critical or noncritical. The critical items are actions that shall be performed immediately to avoid aggravating the emergency.

##### 3.0.2 GENERAL BEHAVIOUR IN EMERGENCY SITUATIONS

As soon as one of the crew member becomes aware that an emergency situation exists, he must immediately alert the other crew member of the situation. In any emergency situation, contact should be established with a ground station as soon as possible after completing the initial corrective action. Include position, altitude, heading, speed, nature of the emergency and pilot's intentions in the first transmission. There after the ground station should be kept informed of the progress of the flight and of any changes or developments in the emergency. Three basic rules apply to most emergencies and should be observed by each aircrew member:

1. Maintain aircraft control
2. Analyse the situation and take proper action
3. Land as soon as possible/as soon as practical

The meaning of "*as soon as possible*" and "*as soon as practical*" as used in this section is as follows:

Land AS SOON AS POSSIBLE (ASAP) = Emergency conditions are urgent and require an immediate landing at the nearest suitable airfield, considering also other factors, such as weather conditions and aircraft mass.

Land AS SOON AS PRACTICAL = Emergency conditions are less urgent and in the aircrews judgement the flight may be safely continued to an airfield where more adequate facilities are available.

### 3.1 AIRSPEEDS FOR EMERGENCY OPERATION

If nothing is mentioned a weight of 840 kg (1852 lbs) is valid.

Stall speed	59 KIAS (109 km/h)
Engine failure after takeoff	80 KIAS (148 km/h)
Best recommended gliding speed ( glide angle 1 : 6,2 )	
-Normal	90 KIAS (167km/h)
-Acro (800 kg)	80 KIAS (148 km/h)
Precautionary landing with engine power	80 KIAS (148 km/h)
Landing without engine power	80 KIAS (148 km/h)
Maximum demonstrated cross wind component	15 Knots (27 km/h)

### 3.2 OPERATIONAL CHECKLIST

#### 3.2.1 ENGINE FAILURE DURING TAKEOFF ROLL

1. Throttle	IDLE
2. Brakes	APPLY
3. Mixture	IDLE CUT OFF
4. Ignition switch	OFF
5. Master switch	OFF

#### 3.2.2 ENGINE FAILURE IMMEDIATELY AFTER TAKEOFF

Stall speed: 59 KIAS (109 km/h)

1. Airspeed	80 KIAS (148 km/h)
2. Mixture	IDLE CUT OFF
3. Fuel shutoff valve	OFF (Pull & Turn)
4. Ignition switch	OFF
5. Master switch	OFF

**WARNING**

The stall warning is deactivated!

6. Forced landing	PERFORM as practical
-------------------	----------------------

#### 3.2.3 ENGINE FAILURE DURING FLIGHT (RESTART PROCESS)

1. Airspeed	80 KIAS (148 km/h)
2. Fuel shutoff valve	"ACRO & CENTER" tank
3. Mixture	RICH
4. Boost pump	ON
5. Ignition switch	BOTH (or START if propeller has stopped)

**3.2.4 OIL SYSTEM MALFUNCTION**

- |                                       |                    |
|---------------------------------------|--------------------|
| If oil pressure indicates low:        | Apply positive "g" |
| If oil pressure is not regained than: |                    |
| 1. Airspeed                           | 80 KIAS (148 km/h) |
| 2. Throttle                           | REDUCE TO IDLE     |
| 3. Engine oil temperature             | OBSERVE INDICATION |
| 4. Land                               | ASAP               |

**WARNING**

If oil pressure drops to 0 psi the propeller pitch changes automatically to coarse (high) pitch with a corresponding decrease in RPM.

**3.2.5 ALTERNATOR FAILURE**

- An alternator failure is indicated by:
- the red light of the low voltage monitor (if installed) or
  - the ampermeter showing negativ current
- |                                     |                   |
|-------------------------------------|-------------------|
| 1. Alternator                       | SWITCH OFF AND ON |
| 2. Low voltage monitor / ampermeter | CHECK INDICATION  |
| 3. Red light off / positive current | CONTINUE FLIGHT   |
- If red light illuminates again / negativ current :
- |         |                      |
|---------|----------------------|
| 4. Land | AS SOON AS PRACTICAL |
|---------|----------------------|

**3.3 FORCED LANDINGS**

**3.3.1 EMERGENCY LANDING WITHOUT ENGINE POWER**

- |                                   |                    |
|-----------------------------------|--------------------|
| 1. Seat belts, shoulder harnesses | SECURE             |
| 2. Airspeed                       | 80 KIAS (148 km/h) |
| 3. Mixture                        | IDLE CUT OFF       |
| 4. Fuel shutoff valve             | OFF (Pull & Turn)  |
| 5. Ignition switch                | OFF                |
| 6. Master switch                  | OFF                |

**WARNING**

The stall warning is deactivated!

- |              |                 |
|--------------|-----------------|
| 7. Touchdown | 3-POINT LANDING |
| 8. Brakes    | AS REQUIRED     |

**3.3.2 PRECAUTIONARY LANDING WITH ENGINE POWER**

- |                                   |   |
|-----------------------------------|---|
| 1. Seat belts, shoulder harnesses | SECURE  |
| 2. Airspeed                       | 80 KIAS (148 km/h)  |
| 3. Selected field                 | FLY OVER,<br>noting terrain and obstructions, then<br>reaching a safe altitude and airspeed |

4. Master switch OFF

**WARNING**

The stall warning is deactivated!

5. Touchdown	3-POINT LANDING
6. Ignition switch	OFF
7. Mixture	IDLE CUT OFF
8. Fuel shutoff valve	OFF (Pull & Turn)
9. Brakes	AS REQUIRED

**3.4 FIRES**

**3.4.1 DURING START ON GROUND**

1. Cranking	CONTINUE to get a start which would suck the flames and accumulated fuel through the air inlet and into the engine.
2. Fuel shutoff valve	OFF (Pull & Turn)
3. Power	1700 RPM for one minute.
4. Engine	SHUT DOWN
5. After engine stop	ABANDON aircraft and inspect for damage
6. Fire	EXTINGUISH using fire extinguisher if available

**WARNING**

Do not open engine compartment access doors while engine is on fire

**3.4.2 IF ENGINE FAILS TO START**

1. Cranking	CONTINUE
2. Throttle	FULL OPEN
3. Mixture	IDLE CUT OFF
4. Fuel shutoff valve	OFF (Pull & Turn)
If fire is extinguished	
5. Master switch	OFF
6. Ignition switch	OFF
7. Engine compartment	INSPECT

### 3.4.3 ENGINE FIRE IN FLIGHT

- |                       |                   |
|-----------------------|-------------------|
| 1. Mixture            | IDLE CUT OFF      |
| 2. Fuel shutoff valve | OFF (Pull & Turn) |
| 3. Master switch      | OFF               |

**WARNING**

The stall warning is deactivated!

- |                             |  |
|-----------------------------|--|
| 4. Airspeed                 | 100 KIAS (185 km/h), find your<br>airspeed/attitude<br>will keep the<br>fire away from the cockpit |
| 5. Land as soon as possible |  |

### 3.5 ICING

#### 3.5.1 INADVERTENT ICING ENCOUNTER

1. Turn back or change altitude to obtain an outside temperature that is less conducive to icing.
2. Plan a landing at the nearest airfield. With extremely rapid ice build-up select a suitable "off airport" landing field.

### 3.6 UNINTENTIONAL SPIN

Refer to section 4 (Normal Procedures) acrobatic maneuvers, spin recovery.

**WARNING**

The engine may stop, during unintentional spin with fuel shutoff valve in "Wingtank" position. After immediate spin recovery start the engine according section 3.2.3 "ENGINE FAILURE DURING FLIGHT".

### 3.7 MANUAL BAIL-OUT

When in an emergency situation that requires abandoning the aircraft and while wearing a parachute, which is at least strongly recommended for acrobatics:

- Inform your passenger
- Reduce speed to 100 KIAS (185 km/h) if possible
- Pull mixture to lean
- Open canopy (the lowpressure over the canopy in normal flight will flip the canopy full open immediately)
- Take off headset
- Open seat belt
- Leave airplane
- Try to avoid wing and tail
- Open parachute

### 3.8 EMERGENCY EXIT AFTER TURN OVER

- |                        |                   |
|------------------------|-------------------|
| 1. Master switch       | OFF               |
| 2. Fuel shutoff valve  | OFF (Pull & Turn) |
| 3. Seat belts          | OPEN              |
| 4. Parachute harnesses | OPEN              |
| 5. Canopy handle       | PULL TO OPEN      |

**NOTE**

If canopy fails to open break the canopy.

- |             |               |
|-------------|---------------|
| 6. Aircraft | EVACUATE ASAP |
|-------------|---------------|

### 3.9 ELEVATOR CONTROL FAILURE

In case of elevator control failure the aircraft can be flown with the elevator trim. In this case trim nose up to the desired speed and control horizontal flight or descend with engine power. For landing trim nose up and establish a shallow descend by adjusting throttle. To flair the plane gently increase power to bring the nose up to landing attitude.

---

---

**SECTION 4**

**NORMAL PROCEDURES**

**Table of Contents**

<i>Paragraph</i>		<i>Page</i>
<b>4.0</b>	<b>GENERAL .....</b>	<b>4-3</b>
4.0.1	Airspeeds For Normal Operation .....	4-3
4.0.2	Checklist And Procedures .....	4-3
<b>4.1</b>	<b>PREFLIGHT INSPECTION .....</b>	<b>4-4</b>
4.1.1	Exterior Inspection Illustration .....	4-4
4.1.2	General .....	4-4
<b>4.2</b>	<b>CHECKLIST PROCEDURES .....</b>	<b>4-4</b>
<b>4.3</b>	<b>STARTING PROCEDURES .....</b>	<b>4-6</b>
4.3.1	Cold Engines .....	4-6
4.3.2	Hot Engines .....	4-7
<b>4.4</b>	<b>TAXIING THE AIRCRAFT .....</b>	<b>4-7</b>
<b>4.5</b>	<b>TAKE-OFF PROCEDURE .....</b>	<b>4-7</b>
4.5.1	Before Take-off .....	4-7
4.5.2	Take-Off .....	4-7
<b>4.6</b>	<b>CLIMB .....</b>	<b>4-8</b>
<b>4.7</b>	<b>CRUISE .....</b>	<b>4-8</b>
<b>4.8</b>	<b>LANDING PROCEDURES .....</b>	<b>4-8</b>
4.8.1	Descent .....	4-8
4.8.2	Approach .....	4-8
4.8.3	Before Landing .....	4-8
4.8.4	Normal Landing .....	4-9
<b>4.9</b>	<b>GO-AROUND .....</b>	<b>4-9</b>
<b>4.10</b>	<b>SHUTDOWN .....</b>	<b>4-9</b>
<b>4.11</b>	<b>LEAVING THE AIRCRAFT .....</b>	<b>4-9</b>
<b>4.12</b>	<b>ACROBATIC MANEUVERS .....</b>	<b>4-10</b>
4.12.1	General .....	4-10
4.12.2	Maneuvers .....	4-10
4.12.3	Spin .....	4-12

**Left blank intentionally**

**SECTION 4**

**NORMAL PROCEDURE**

**4.0 GENERAL**

**4.0.1 AIRSPEEDS FOR NORMAL OPERATION**

CATEGORY	ACRO		NORMAL KIAS (km/h)
	1 seat KIAS (km/h)	2 seats KIAS (km/h)	
Takeoff:			
-Rotating Speed	70 (130)	72 (133)	73 (135)
Climb:			
-Vx	72 (133)	74 (137)	75 (139)
-Vy	84 (156)	85 (157)	86 (159)
-Recommended Normal Climb Speed	95 (176)	100 (185)	105 (194)
-Max. Cruise	154 (285)	154 (285)	154 (285)
Landing:			
-Approach	80 (148)	85 (157)	90 (167)
-on Final	70 (130)	72 (133)	73 (135)
-Go-Around Speed	90 (167)	95 (176)	100 (185)
Recommended Airspeed For Flight In Rough Air (maximum)	130 (241)	130 (241)	130 (241)
Max. Demonstrated Cross Wind Component	15 kts (27)	15 kts (27)	15 kts (27)

**4.0.2 CHECKLIST AND PROCEDURES**

This handbook contains the checklist and procedures to operate the aircraft in normal and acrobatic operation. The pilot should be familiar with all procedures contained in this Pilot's Operating Handbook, which should be carried on board. The pilot has to comply with Checklist for daily check and inspections (see Section 8, Handling, Servicing and Maintenance).

**4.1 PREFLIGHT INSPECTION**

**4.1.1 EXTERIOR INSPECTION ILLUSTRATION**

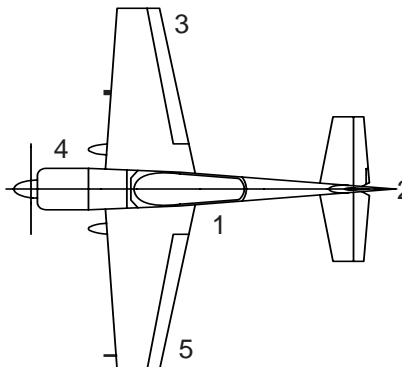

**4.1.2 GENERAL**

Visually check airplane for general condition during walk around inspection. Perform exterior check as outlined in the picture above in counterclockwise direction.

**4.2 CHECKLIST PROCEDURES**

**1) Cockpit**

- |                                |                 |
|--------------------------------|-----------------|
| 1. Pilot's Operating Handbook  | (AVAILABLE)     |
| 2. Airplane weight and balance | CHECKED         |
| 3. Ignition switch             | OFF             |
| 4. Master switch               | ON              |
| 5. Fuel quantity indicators    | CHECK           |
| 6. Master switch               | OFF             |
| 7. Fuel selector *             | "ACRO & CENTER" |

**NOTE \***

Although safe operation did not require the use of the tanks in a specific sequence, it is recommended to set fuel selector to "ACRO & CENTER" Tank position!

- |                       |                                  |
|-----------------------|----------------------------------|
| 8. Pitot-Static-Drain | CHECK FOR WATER<br>ACCUMULATIONS |
|-----------------------|----------------------------------|

**NOTE**

If water exists, drain by removing the plug. Reinstall plug.

- |                         |                      |
|-------------------------|----------------------|
| 9. "Acro & Center" Tank | CHECK<br>FOR LEAKAGE |
|-------------------------|----------------------|

**NOTE**

Pay attention for fuel accumulations between alu-tank and GRP-cover. (This is indicated by a blue color)

---

---

## 2) Empennage

- |  |   |
|--|---|
| 1. All round inspection, canopy, surfaces, stabilizer, elevator, trim rudder and tailwheel | CHECK   |
| 2. Horizontal stabilizer attachment bolts  | CHECK FOR FREEPLAY BY MOVING THE TIP OF THE HORIZ. STABILIZER UP- AND DOWNWARDS |

## 3) Right Wing

- |  |       |
|--|-------|
| 1. Aileron, freedom of movement and security   | CHECK |
| 2. Trailing edge                               | CHECK |
| 3. Fuel tank vent opening (right landing gear) | CHECK |
| 4. Fuel quantity                               | CHECK |
| 5. Fuel tank filler cap                        | CHECK |
| 6. Right landing gear, wheel and brake         | CHECK |
| 7. Stall warning vane                          | CHECK |

## 4) Nose

- |   |   |
|---|---|
| 1. Engine oil dipstick                  | CHECK   |
| 2. Propeller and spinner                | CHECK   |
| 3. Air inlet                            | CHECK   |
| 4. Fuel quantity ("Acro & Center" tank) | CHECK   |
| 5. Fuel tank filler cap                 | CHECK   |
| 6. "Acro & Center" tank drain           | DRAIN FOR AT LEAST 4 SECONDS TO CLEAR SUMP OF POSSIBLE WATER;<br>CHECK CLOSED   |
| 7. "Wing tank" drain                    | DRAIN FOR AT LEAST 4 SECONDS TO CLEAR SUMP OF POSSIBLE WATER;<br>CHECK CLOSED   |
| 8. Fuel filter drain                    | DRAIN FOR AT LEAST 4 SECONDS TO CLEAR FILTER OF POSSIBLE WATER;<br>CHECK CLOSED |

## 5) Left wing

- |  |        |
|--|--------|
| 1. Left landing gear, wheel and brakes       | CHECK  |
| 2. Fuel quantity                             | CHECK  |
| 3. Fuel tank filler cap                      | CHECK  |
| 4. Pitot cover                               | REMOVE |
| 5. Trailing edge                             | CHECK  |
| 6. Aileron, freedom of movement and security | CHECK  |
- 
-

## 6) Before starting engine

1. Preflight inspection	COMPLETE
2. Passenger briefing	COMPLETE
3. Parachute handling briefing	COMPLETE
4. Seats, seatbelts, shoulder harnesses	ADJUST AND LOCK
5. Canopy	CLOSE AND LOCK
6. Brake	CHECK
7. Master switch	ON
8. Avionics power switch	OFF
9. Electrical equipment	OFF
10. Alternator	ON
11. Wingtip position / Strobe lights	ON

## 4.3 STARTING PROCEDURES

### 4.3.1 COLD ENGINES

The following starting procedures are recommended, however, the starting conditions may necessitate some variation from these procedures.

1. Perform preflight inspection.
2. Set propeller governor control to "High RPM" position.
3. Open throttle approximately 1/4 travel.
4. Turn boost pump "ON".
5. Move mixture control to "FULL RICH" until a slight but steady fuel flow is noted (approximately 3 to 5 seconds) and return mixture control to "IDLE CUT-OFF".  
Turn boost pump "OFF".
6. Engage starter.
7. When engine fires release the ignition switch back to "BOTH".
8. Move mixture control slowly and smoothly to "FULL RICH".
9. Check the oil pressure gauge. If minimum oil pressure is not indicated within 30 seconds, shut off the engine and determine trouble.

---

### 4.3.2 HOT ENGINES

Because of the fact that the fuel percolates and the system must be cleared of vapour, it is recommended to use the same procedure as outlined for cold engine start.

### 4.4 TAXIING THE AIRCRAFT

1. Canopy	CLOSE AND LOCK
2. Brake	CHECK
3. Altimeter	Set on QFE or QNH Scale error max. +60 ft.
4. Avionic master switch	ON
5. Electrical equipment	ON
6. Radio	Set and test
7. Mixture	Leave in "FULL RICH" position

Operate only with the propeller in minimum blade angle (High RPM).  
Warm-up at approximately 1000-1200 RPM. The engine is ready for takeoff when the throttle can be opened without the engine faltering.

### 4.5 TAKE-OFF PROCEDURE

#### 4.5.1 BEFORE TAKE-OFF

Before you line up at the runway for takeoff:

- Check oil pressure and oil temperature.
- Check the magnetos at 1800 RPM. Allowed drop is 175 RPM (max. difference 50 RPM).
- Check Alternator Output.
- Move also the propeller control through its complete range to check operation and return to full "HIGH RPM" position.  
Turn boost pump "ON" (check indicator movement on the fuel pressure gauge).

<b>NOTE</b>
-------------

The RPM Gauge is electronically operated. To check the magnetos the RPM source switch must be set to the same magneto as the ignition switch. Otherwise the gauge will show zero.

#### 4.5.2 TAKE-OFF

Set throttle smoothly to max and let the airspeed go up to 70-75 KIAS (130-139 km/h). A light pressure on the stick lifts the tail to horizontal position. Rotate the aircraft at 75 KIAS (139 km/h). On reaching climb speed of 100 KIAS (185 km/h) reduce the RPM to 2500 and proceed climbing.

#### 4.6 CLIMB

The maximum continuous RPM is restricted to 2500.

Turn boost pump "OFF".

#### 4.7 CRUISE

- |                   |                             |
|-------------------|-----------------------------|
| 1. Altitude       | - As selected               |
| 2. Throttle / RPM | - Adjust for cruising speed |
| 3. Mixture        | - Adjust for cruising speed |
| 4. Trim           | - As required               |
| 5. Fuel           | - Check periodically        |

#### 4.8 LANDING PROCEDURES

##### 4.8.1 DESCENT

- |                         |                        |
|-------------------------|------------------------|
| 1. Throttle             | - Reduce               |
| 2. Mixture              | - "FULL RICH"          |
| 3. Trim                 | - Adjust               |
| 4. Fuel selector valve* | - "ACRO & CENTER" tank |

**NOTE**

Although safe operation did not require the use of the tanks in a specific sequence, it is recommended to set fuel selector to "ACRO & CENTER" tank position!

##### 4.8.2 APPROACH

- |               |                                 |
|---------------|---------------------------------|
| 1. Boost pump | - ON                            |
| 2. Mixture    | - Set to "RICH"                 |
| 3. Airspeed   | - Reduce to approach speed      |
| 4. Propeller  | - Set to low pitch ("HIGH RPM") |

**NOTE**

It is recommended to reduce the RPM during approach and landing in order to avoid unnecessary noise.

In case of "Go Around", RPM control must be set to max. RPM before applying power.

##### 4.8.3 BEFORE LANDING

- |                      |                               |
|----------------------|-------------------------------|
| 1. Landing approach  | - Proceed                     |
| 2. Airspeed on final | - Maintain 75 KIAS (139 km/h) |
| 3. Elevator trim     | - Adjust                      |

**NOTE**

Stall speed will be

MTOW = 700 kg :	53 KIAS (98 km/h)
MTOW = 800 kg :	58 KIAS (107 km/h)
MTOW = 840 kg :	59 KIAS (109 km/h)

**4.8.4 NORMAL LANDING**

- |              |  |
|--------------|--|
| 1. Landing   | - Perform as practicable with respect to surface and weather condition |
| 2. Touchdown | - 3 point landing  |

**NOTE**

The rudder is effective down to 30 KIAS (56 km/h) airspeed

- |             |                    |
|-------------|--------------------|
| 3. Throttle | - CLOSE / IDLE     |
| 4. Braking  | - Minimum required |

**4.9 GO-AROUND**

Decide early in the approach if it is necessary to go around and then start go-around before too low altitude and airspeed are reached.

Proceed as follows:

- |                |  |
|----------------|--|
| 1. RPM control | - "HIGH RPM" / Full forward                                  |
| 2. Throttle    | - "OPEN" / TAKEOFF power                                     |
| 3. Airspeed    | - Minimum 90 KIAS (167 km/h)<br>Rotate to go-around attitude |

**4.10 SHUTDOWN**

- |                          |                              |
|--------------------------|------------------------------|
| 1. Boost pump            | - "OFF"                      |
| 2. Engine                | - Run for 1 min. at 1000 RPM |
| 3. Dead cut check        | - Perform                    |
| 4. Avionic master switch | - "OFF" (if installed)       |
| 5. Mixture               | - "IDLE CUT OFF"             |
| 6. Ignition switch       | - "OFF"                      |
| 7. Master switch         | - "OFF"                      |

**4.11 LEAVING THE AIRCRAFT**

- |                |                  |
|----------------|------------------|
| 1. Canopy      | - Close and lock |
| 2. Aircraft    | - Secure         |
| 3. Pitot cover | - Attach         |
| 4. Log book    | - Comply         |

## 4.12 ACROBATIC MANEUVERS

### 4.12.1 GENERAL

**NOTE**

Prior to executing these maneuvers tighten harnesses and check all loose items are stowed. Start the maneuvers at safe altitude and max continuous power setting if not otherwise noted.

For maneuver limits refer to Section 2 LIMITATIONS.

After termination of acrobatic maneuvers the artificial horizon (if installed) must be reset if possible.

At high negative g-loads and zero g-periods it is normal that oil pressure and RPM indication might drop down momentarily returning to normal status at positive g-loads.

**WARNING**

The high permissible load factors of the airplane may exceed the individual physiological limits of pilot or passenger. This fact must be considered when pulling or pushing high g's.

### 4.12.2 MANEUVERS

**CAUTION**

Particular caution must be exercised when performing maneuvers at speeds above  $V_A$  [154 KIAS (285 km/h)]. Large or abrupt control inputs above this speed may impose unacceptably high loads which exceed the structural capability of the aircraft.

Acrobatics is traditionally understood as maneuvers like loop, humpty bump, hammerhead turn, aileron roll etc..

This manual does not undertake to teach acrobatics, however, it is meant to demonstrate the plane's capabilities.

For this reason maneuvers are divided into segments. The segments are described. Limitations are pointed out.

- Segment horizontal line:

A horizontal line may be flown with any speed between  $V_S$  and  $V_{NE}$ .

- Segment "line 45° climbing":  
The plane will follow the line at max. power. The speed will not decrease below 80 KIAS (148 km/h).
- Segment "line 90° up":  
Any entry speed may be used. Out of a horizontal pull-up at 200 KIAS (370 km/h) the vertical penetration will be 2.500 ft. The speed will gradually decrease to 0.

**NOTE**

In extremely long "line 90° up" an RPM decay may occur. This is related to a loss of oil pressure. Positive g's should be pulled immediately in order to protect the engine. Oil pressure will return immediately.

- Segment "line 45° diving":  
Throttle must be reduced in order to avoid exceeding  $V_{NE}$ .
- Segment "line 90° diving":  
Throttle must be reduced to idle in order to avoid exceeding  $V_{NE}$ .

Above segments may be filled up with aileron rolls on snap rolls. Watch  $V_A = 154$  KIAS (285 km/h) for aileron rolls with max. deflection. Snap rolls should not be performed at speeds above 138 KIAS (256 km/h).

- Segment "1/4 loop, climbing":  
The minimum recommended speed is 100 KIAS (185 km/h). If the maneuver is to be followed by a vertical line, a higher entry speed is required depending on the expected length of the line. A complete loop can be performed at speeds above 100 KIAS (185 km/h).

**NOTE**

Since the maximum horizontal speed is 185 KIAS (343 km/h), higher speeds should be avoided in acrobatics since an unnecessary loss of altitude would occur.

- Torque maneuvers:  
All maneuvers with high angular velocity associated with high propeller RPM must be considered dangerous for the engine crankshaft.

Although wooden composite propeller blades are used, the gyroscopic forces at the prop flange are extremely high.

**CAUTION**

If performing a gyroscopic maneuver such as flat spin, power on, or knife edge spin, reduce RPM to 2400 in order to minimize the gyroscopic forces.

**4.12.3 SPIN**

To enter a spin proceed as follows:

- Reduce speed, power idle
- When the plane stalls:
- Kick rudder to desired spin direction
- Hold ailerons neutral
- Stick back (positive spinning), Stick forward (negative spinning)

The plane will immediately enter a stable spin.

- Ailerons against spin direction will make the spin flatter.
- Ailerons into spin direction will lead to a spiral dive.

Above apply for positive and negative spinning.

To stop the spin:

- Apply opposite rudder
- Make sure, power idle
- Hold ailerons neutral
- Stick to neutral position

The plane will recover within 1/2 turn.

Recovery can still be improved by feeding in in-spin ailerons.

**NOTE**

If ever disorientation should occur during spins (normal or inverted) one method always works to stop the spin:

- Power idle
- Kick rudder to the heavier side  
(this will always be against spin direction)
- Take hands off the stick

The spin will end after 1/2 turn. The plane will be in a steep dive in a side-slip.

Recovery to normal flight can be performed easily.

**NOTE**

After six turns of spinning the altitude loss including recovery is 2800 ft.

---

---

**SECTION 5**

**PERFORMANCE**

Table Of Contents

<i>Paragraph</i>		<i>Page</i>
<b>5.1</b>	<b>GENERAL .....</b>	<b>5-3</b>
5.1.1	Performance Charts .....	5-3
5.1.2	Definitions Of Terms .....	5-3
5.1.3	Sample Problem .....	5-4
<b>5.2</b>	<b>ISA CONVERSION .....</b>	<b>5-5</b>
<b>5.3</b>	<b>AIRSPEED CALIBRATION .....</b>	<b>5-6</b>
<b>5.4</b>	<b>STALL SPEED .....</b>	<b>5-7</b>
<b>5.5</b>	<b>TAKEOFF PERFORMANCE .....</b>	<b>5-8</b>
<b>5.6</b>	<b>RATE OF CLIMB PERFORMANCE .....</b>	<b>5-9</b>
<b>5.7</b>	<b>TIME, FUEL AND DISTANCE TO CLIMB .....</b>	<b>5-10</b>
<b>5.8</b>	<b>TIME, FUEL AND DISTANCE TO DESCEND .....</b>	<b>5-11</b>
<b>5.9</b>	<b>CRUISING SPEED .....</b>	<b>5-12</b>
<b>5.10</b>	<b>ENDURANCE .....</b>	<b>5-13</b>
<b>5.11</b>	<b>RANGE .....</b>	<b>5-14</b>
<b>5.12</b>	<b>CRUISE PERFORMANCE .....</b>	<b>5-15</b>
<b>5.13</b>	<b>LANDING DISTANCE .....</b>	<b>5-16</b>

**Left blank intentionally**

## SECTION 5

### PERFORMANCE

#### 5.1 GENERAL

Performance data charts on the following pages are presented to facilitate the planning of flights in detail and with reasonable accuracy under various conditions. The data in the charts have been computed from actual flight tests with the aircraft and engine in good condition and using average piloting techniques.

It should be noted that the performance information presented in the range and endurance charts allow for 45 minutes reserve fuel at specified speeds. Some indeterminate variables such as engine and propeller, air turbulence and others may account for variations as high as 10% or more in range and endurance. Therefore, it is important to utilize all available information to estimate the fuel required for the particular flight.

##### 5.1.1 PERFORMANCE CHARTS

Performance data are presented in tabular or graphical form to illustrate the effect of different variables. Sufficiently detailed information are provided in the tables so that conservative values can be selected and used to determine the particular performance figure with reasonable accuracy.

All speeds in this chapter are Indicated Air Speeds (IAS). The performance figures below are given under following conditions.

1. Maximum allowed weight 840 kg (1852 lbs) except otherwise stated
2. Takeoff and landing on concrete surface.
3. No wind.
4. Standard atmospheric condition.

##### 5.1.2 DEFINITIONS OF TERMS

For definition of terms, abbreviations and symbols refer to section 1, General.

### 5.1.3 SAMPLE PROBLEM

#### CONDITIONS

Airfield Pressure Altitude: 1500 ft (457 m),      Outside air temperature on ground: 20°C  
 Cruising flight in FL 80 [8000 ft (2438 m)],      Outside air temperature in FL 80: 10°C

#### TAKEOFF

The takeoff distance with T/O weight of 840kg (1852 lbs) is shown by Fig. 5.5

Result:    Ground Roll: 257 m  
                  Total Distance to clear a 50 ft (15 m) obstacle: 407 m

#### RATE OF CLIMB

The rate of climb in FL 80 (2438 m) with an aircraft weight of 750 kg is shown by Fig. 5.6

Result:    Rate of climb: 950 ft/min

#### TIME, FUEL AND DISTANCE TO CLIMB

The values from airfield level 1500 ft (457 m) to FL 80 (2438 m) with an aircraft weight of 800 kg is shown by Fig. 5.7:

Result:    Time: (8.7 - 1.9) min = 6.8 min  
                  Distance: (13 - 2.8) NM = 10.2 NM  
                  Fuel consumption: (8.3 - 1.9) liters = 6.4 liters

#### CRUISING SPEED

The cruising speed in FL 80 (2438 m) with an aircraft weight of 840 kg and power setting of 65% is shown by Fig. 5.9.

Result:    Cruising speed : 148 KTAS (274 km/h)

Cruise Altitude and Power Setting should be determined for most economical fuel consumption and several other considerations.

#### FUEL CONSUMPTION

The fuel consumption in FL 80 (2438 m) with an aircraft weight of 840 kg and power setting of 65% is shown by Tab. 5.12.

Result:    Fuel consumption: 34 liters per hour

#### RANGE

The range in FL 80 (2438 m) with an aircraft weight of 840 kg (1852 lbs) and power setting of 65%, is shown by Tab. 5.12, including fuel for warm up and takeoff from SL, max continuous Power climb to cruising altitude, and a reserve of 19 liters (5 US Gal.) for 45 minutes with 45% Power. 5 liters (1.3 US Gal.) unusable fuel is taken into account.

Total fuel:	122 L	(32 US Gal.)
Warm up & T/O:	-4 L	(-1.05 US Gal.)
Reserve:	-19 L	(-5 US Gal.)
Unusable fuel:	-5 L	(-1.3 US Gal.)
Usable fuel:	<u>94 L</u>	<u>(24 US Gal.)</u>

Result:    Range:        386 NM (714 km)

#### Endurance

The endurance in FL 80 (2438 m) is shown by Tab. 5.10.

Result:        Endurance: 2.66 hours

**5.2 ISA CONVERSION**

ISA Conversion of pressure altitude and outside air temperature

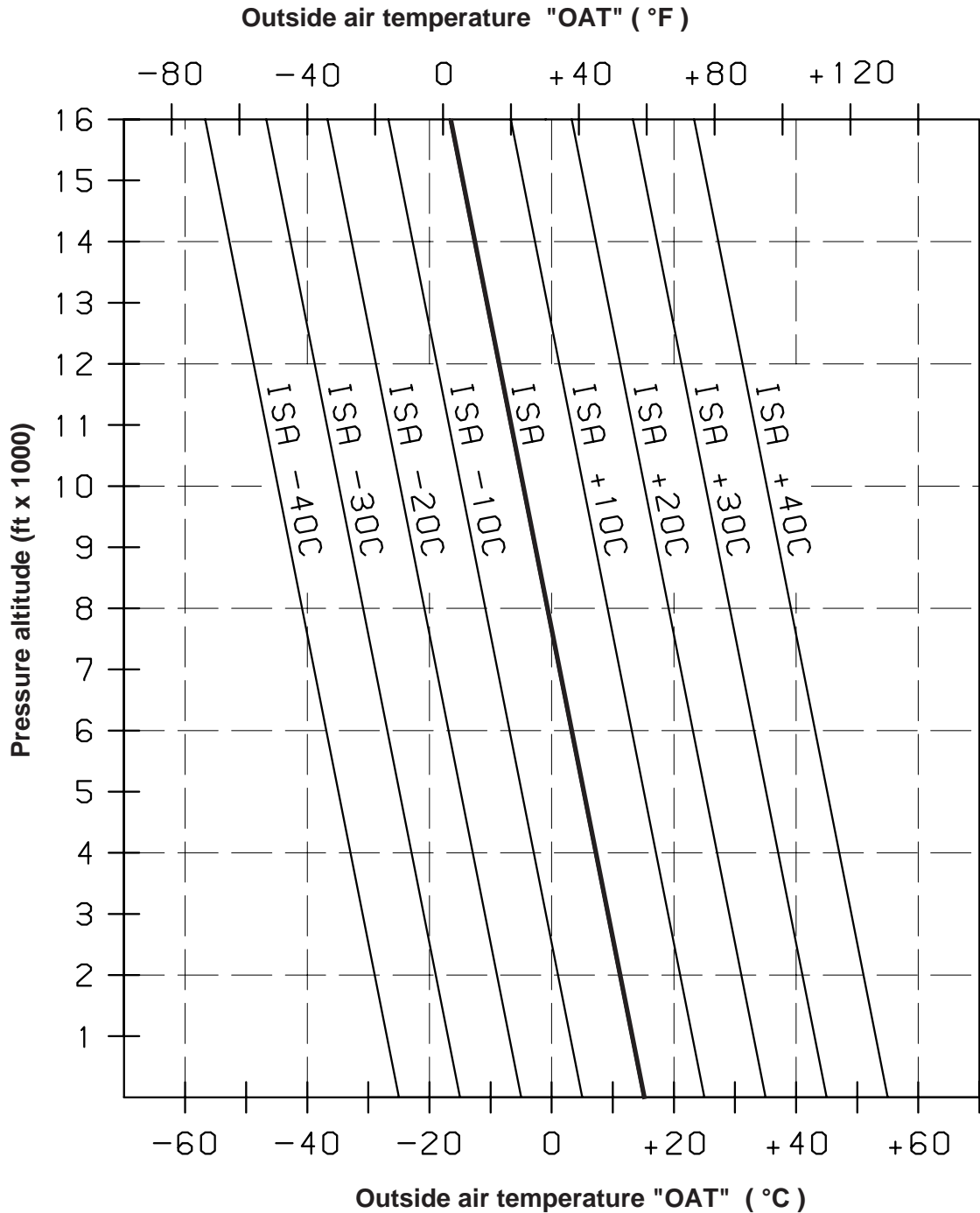

## 5.3 AIRSPEED CALIBRATION

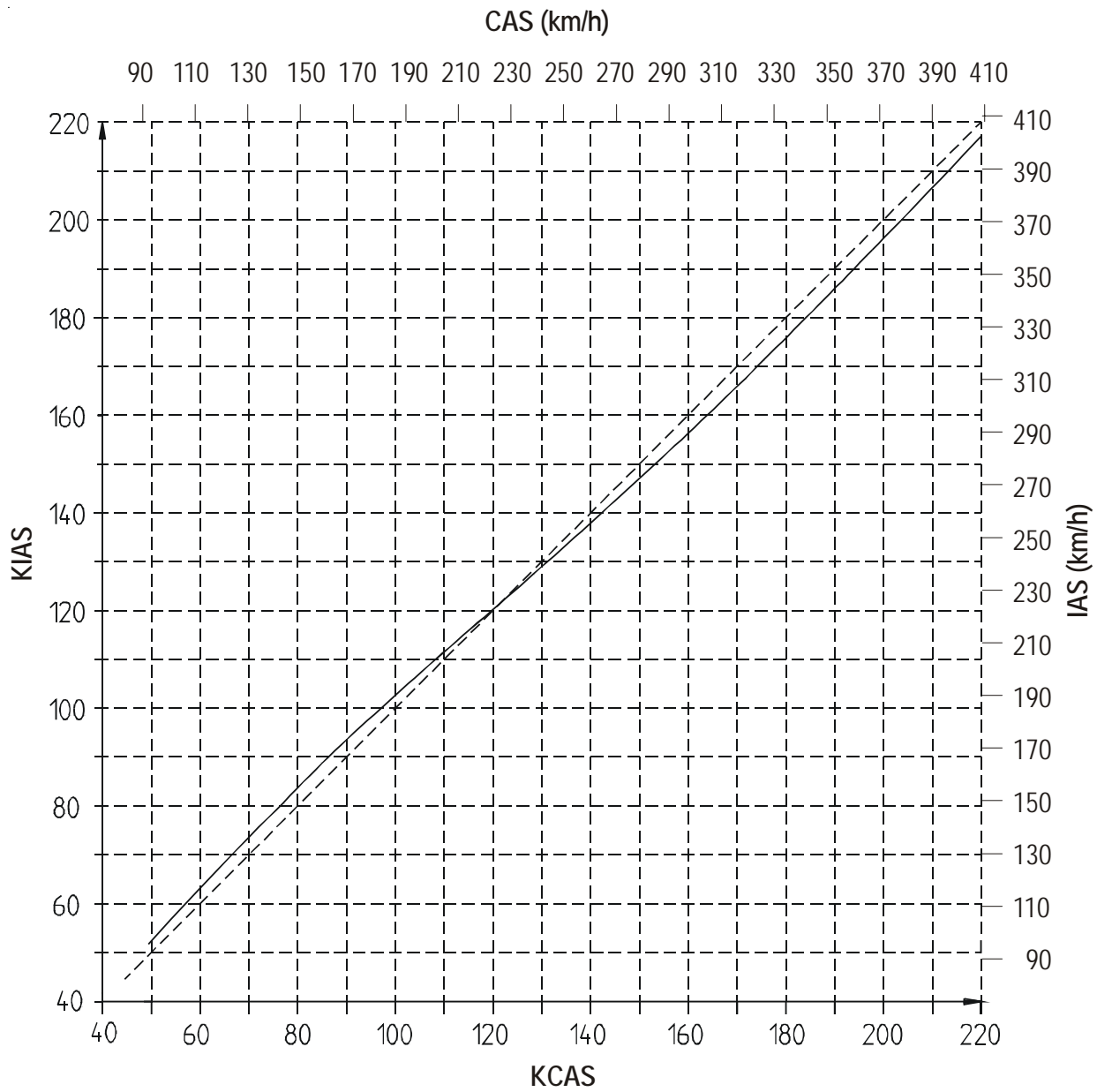

**NOTE**

Indicated airspeed assumes zero instrument error

**5.4 STALL SPEED**

Condition:  
Power Idle  
Forward C.G. position

WEIGHT	CATEGORY	ANGLE OF BANK							
		0°		30°		45°		60°	
		KIAS (km/h)	KCAS (km/h)	KIAS (km/h)	KCAS (km/h)	KIAS (km/h)	KCAS (km/h)	KIAS (km/h)	KCAS (km/h)
840 kg (1852 lbs)	<b>NORMAL</b>	59 (109)	56 (104)	64 (119)	60 (111)	72 (133)	67 (124)	82 (152)	79 (146)
800 kg (1763 lbs)	<b>ACRO</b> (2 seat)	58 (107)	55 (102)	63 (117)	59 (109)	70 (130)	65 (120)	81 (150)	78 (144)
700 kg (1543 lbs)	<b>ACRO</b> (1 seat)	53 (98)	51 (94)	58 (107)	55 (102)	65 (120)	61 (113)	75 (139)	72 (133)

Max. altitude loss during stall recovery is approximately 100 ft (30 m).

**5.5 TAKEOFF PERFORMANCE**

Power: 2700 RPM and full throttle before brake release  
Landing runway: paved level dry runway

For every 5 kts (9 km/h) headwind, the takeoff (T/O) distance can be decreased by 5%. For every 2 kts (4 km/h) tailwind [up to 10 kts (19 km/h)], the (T/O) distance is increased by 10%. On a solid, dry and plain Grass Runway, the T/O distance is increased by 15%.

**Weight: 700 kg (1543 lbs)**   Liftoff speed (T/O): 70 KIAS (130 km/h)  
Takeoff distance in meter   Obstacle clearance speed over 15m (50ft) : 75 KIAS (139 km/h)

	-20°C OAT		-10°C		0°C		10°C		20°C		30°C		40°C	
PA	T/O	50 ft	T/O	50 ft	T/O	50 ft	T/O	50 ft	T/O	50 ft	T/O	50 ft	T/O	50 ft
Sea level	116	183	129	205	144	228	160	253	177	280	195	309	214	340
2000	135	213	151	239	168	266	186	295	206	327	227	360	250	396
4000	157	249	176	279	196	311	218	345	241	382	266	422	293	464
6000	184	292	206	327	230	364	255	405	283	448	312	495	344	545
8000	216	343	242	384	270	429	301	476	333	528	368	583	405	642

Takeoff distance in ft

	-20°C OAT		-10°C		0°C		10°C		20°C		30°C		40°C	
PA	T/O	50 ft	T/O	50 ft	T/O	50 ft	T/O	50 ft	T/O	50 ft	T/O	50 ft	T/O	50 ft
Sea level	381	600	423	673	472	748	525	830	581	919	640	1014	702	1115
2000	443	699	495	784	551	873	610	968	676	1073	745	1181	820	1299
4000	515	817	577	915	643	1020	715	1132	791	1253	873	1385	961	1522
6000	604	958	676	1073	755	1194	837	1329	928	1470	1024	1624	1129	1788
8000	709	1125	794	1260	886	1407	988	1562	1093	1732	1207	1913	1329	2106

**Weight: 840 kg (1852 lbs)**   Liftoff speed (T/O): 73 KIAS (135 km/h)  
Takeoff distance in meter   Obstacle clearance speed over 15m (50ft) : 78 KIAS (144 km/h)

	-20°C OAT		-10°C		0°C		10°C		20°C		30°C		40°C	
PA	T/O	50 ft	T/O	50 ft	T/O	50 ft	T/O	50 ft	T/O	50 ft	T/O	50 ft	T/O	50 ft
Sea level	149	236	167	264	186	295	206	327	228	362	252	399	277	438
2000	174	275	194	308	217	343	240	381	266	422	293	465	323	512
4000	203	321	227	360	253	401	281	446	311	493	343	544	378	599
6000	238	377	238	422	297	470	330	523	365	579	403	639	444	703
8000	279	442	313	496	349	553	388	615	430	681	475	752	523	828

Takeoff distance in ft

	-20°C OAT		-10°C		0°C		10°C		20°C		30°C		40°C	
PA	roll	50 ft	roll	50 ft	roll	50 ft	roll	50 ft	roll	50 ft	roll	50 ft	roll	50 ft
Sea level	489	774	548	866	610	968	676	1073	748	1188	827	1309	909	1437
2000	571	902	636	1010	712	1125	787	1250	873	1385	961	1526	1060	1680
4000	666	1053	745	1181	830	1316	922	1463	1020	1617	1125	1785	1240	1965
6000	781	1237	781	1385	974	1542	1083	1716	1198	1900	1322	2096	1457	2306
8000	915	1450	1027	1627	1145	1814	1273	2018	1411	2234	1558	2467	1716	2717

**5.6 RATE OF CLIMB PERFORMANCE**

Weight	Airspeed during climb KIAS (km/h)		
	sea level	5000 ft	12000 ft
840 Kg (1852 lbs)	86 (159)	84 (156)	82 (152)
700 Kg (1543 lbs)	84 (156)	82 (152)	80 (148)

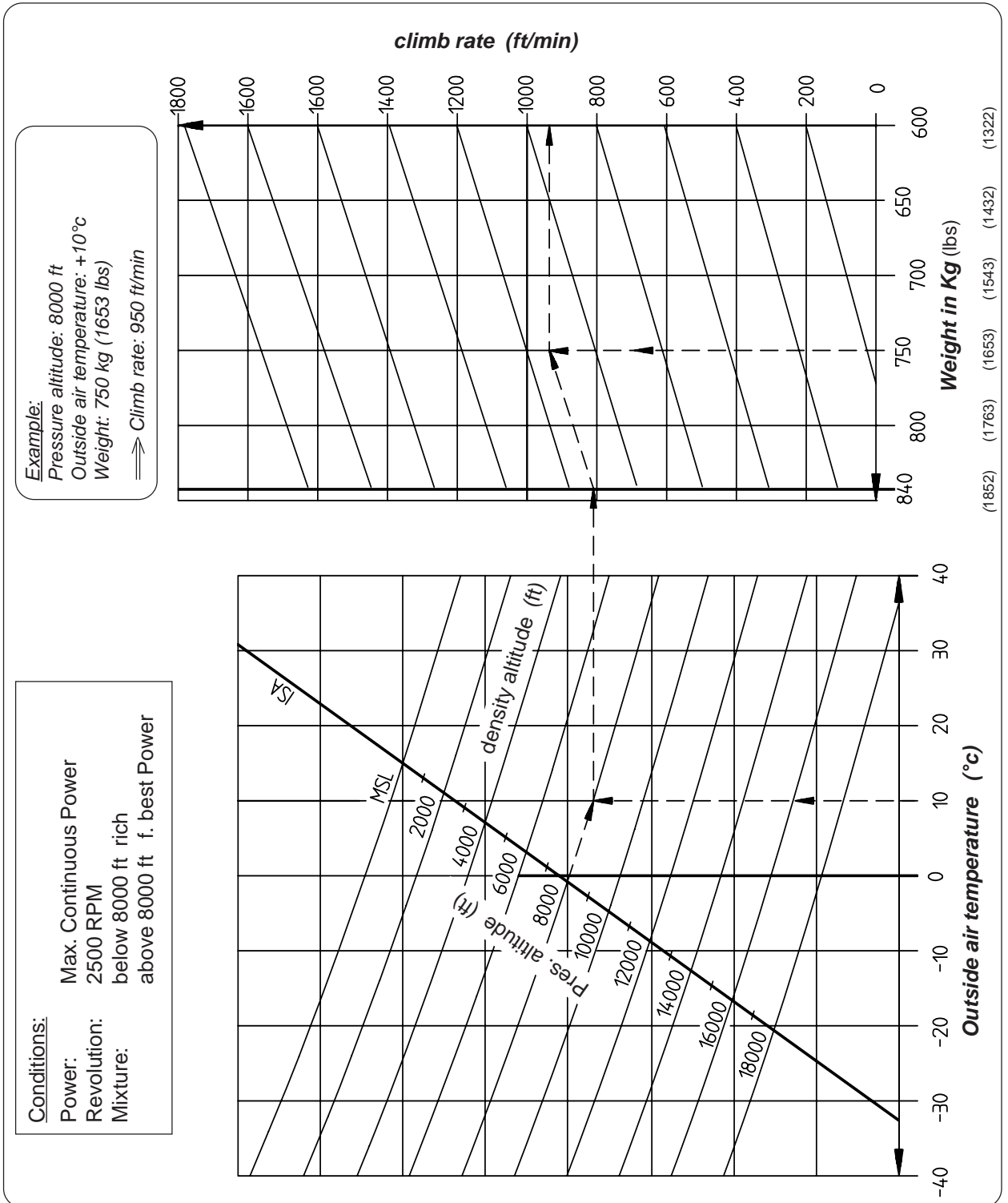

5.7 TIME, FUEL AND DISTANCE TO CLIMB

**Example**

Weight: 800 kg (1764 lbs)      Cruise pres. altitude: 8000 ft  
 Airfield pres. altitude: 1500 ft      Outside air temperature +10°C  
 Airfield temperature: +20°C  
 Climb time: 8,7-1,9=6,8 min  
 Distance: 13-2,8=10,2 NM  
 Fuel consumption: 8,3-1,9= 6,4 liters (1.6 US. Gal.)

**Conditions:**

No Wind,  
 Power: Max. continuous power  
 Revolution: 2500 RPM  
 Mixture: below 8000 ft: rich  
           above 8000 ft: for best power

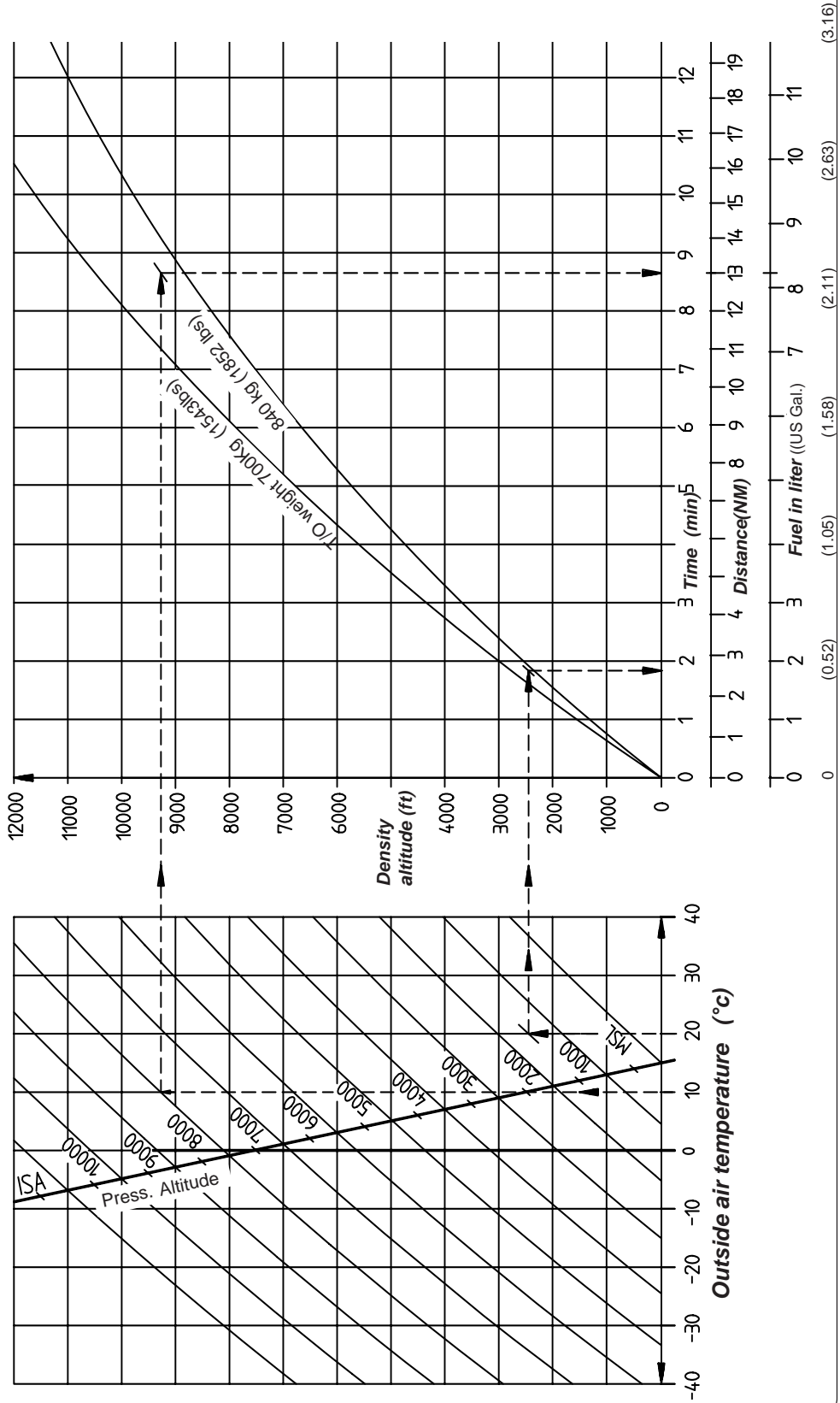

**5.8 TIME, FUEL AND DISTANCE TO DESCEND**

During the descent adjust the engine power for  $V = 150$  KIAS and a rate of descent of 1000ft/min. Furthermore the engine temperature has to be kept in the green range. The diagram below may be used for all A/C masses and temperatures.

Condition:  
No Wind,  
Manifold pres. as required, ca. 12 inHg  
Revolution: 2500 RPM

Example

Airfield pres. altitude: 1200 ft  
Cruise pres. altitude: 8000 ft

Time to descend  $8.0 - 1.2 = 7.8$  min

Distance:  $21 - 3 = 18$  NM

⇒ Fuel consumption:  $4.0 - 0.6 = 3.4$  Liter

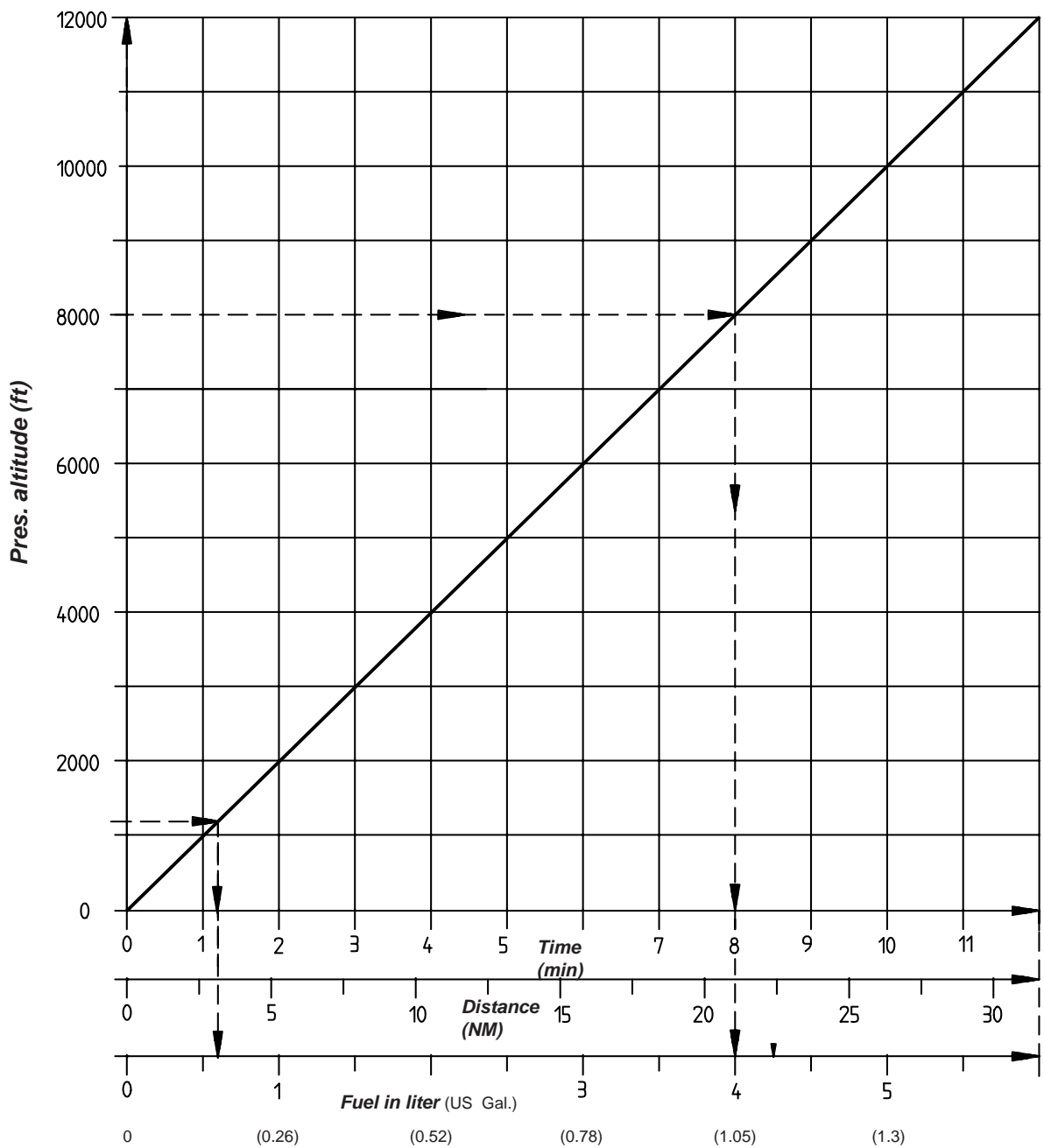

**5.9 CRUISING SPEED**

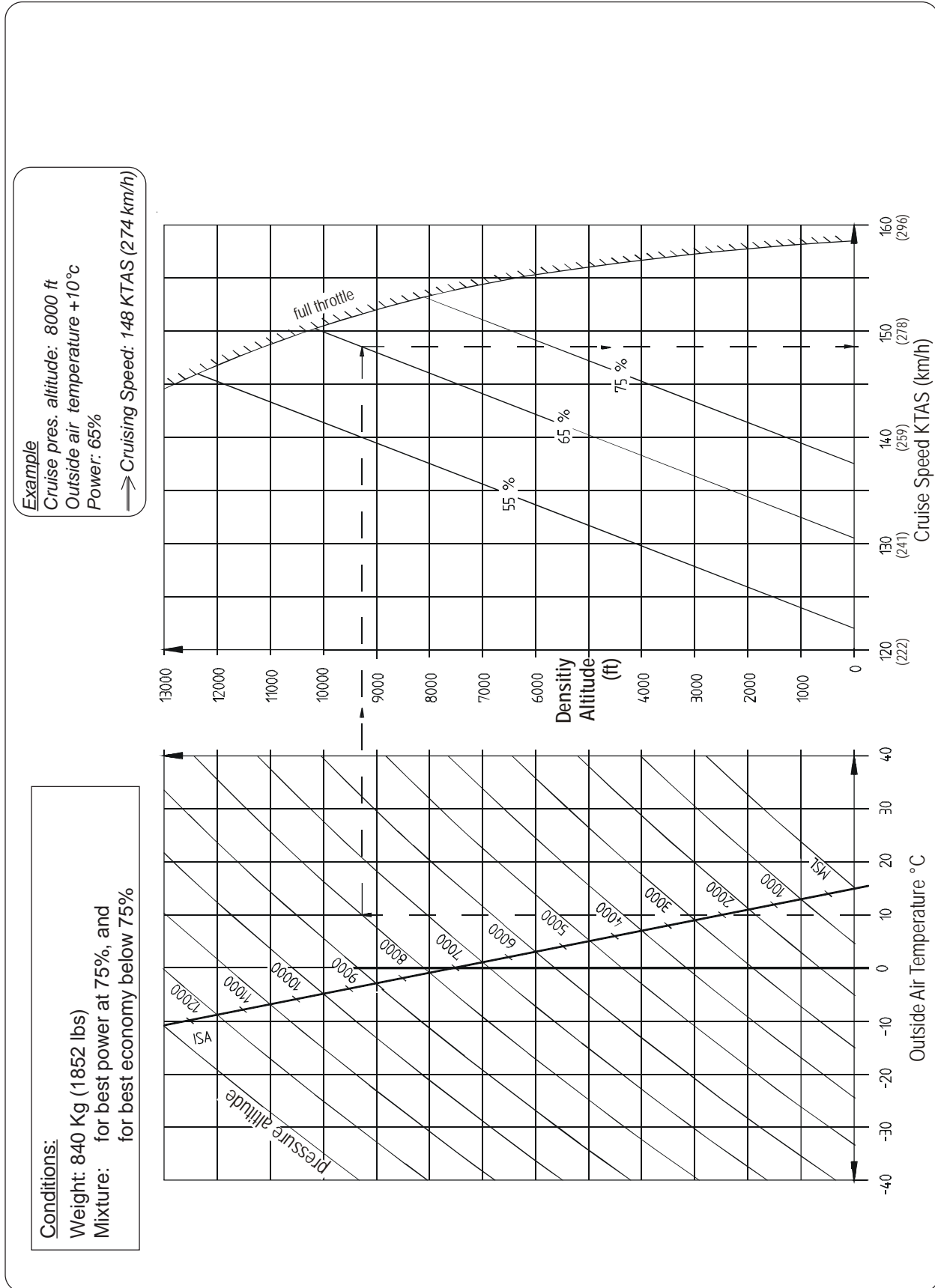

5.10 ENDURANCE

**Example**  
Cruise pres. altitude: 8000 ft  
Outside air temperature +10°C  
Power: 65%, 2350 RPM, 21.5 in Hg  
→ Endurance: 2.66 h

**Conditions:**  
Weight: 840 Kg (1852 lbs), total fuel: 117 liter (30.8 US Gal.), less 4 liter (1.05 US Gal.) for warm up and taxi, less 19 liter (5 US Gal.) for a flightreserve of 45 min at 45% power.

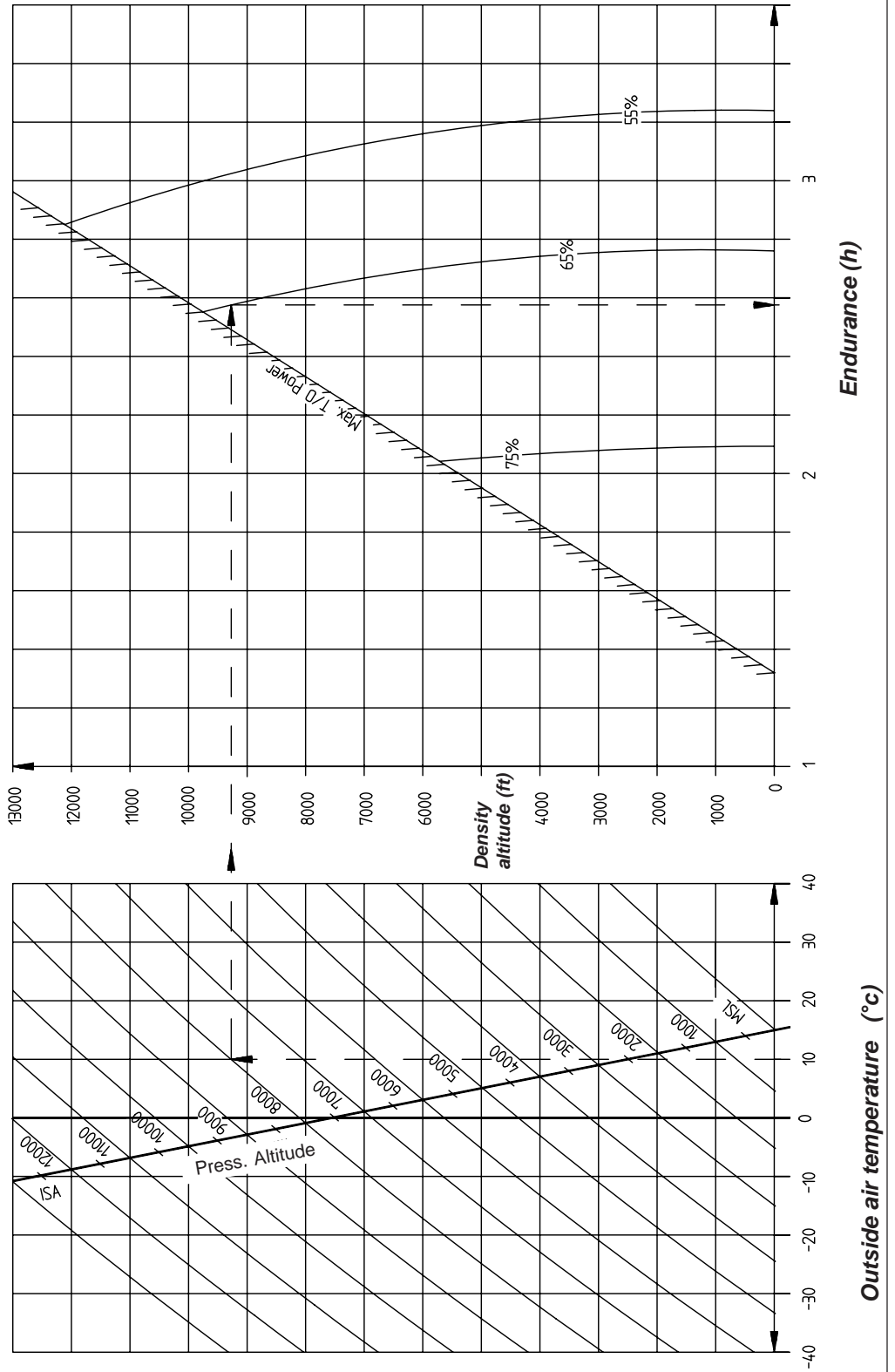

**5.11 RANGE**

**Example**  
Cruise pres. altitude: 8000 ft  
Outside air temperature +10°C  
Power: 65%, 2350 RPM, 21.5 in Hg  
→ Range: 386 NM

**Conditions:**  
Weight: 840 Kg (1852 lbs), total fuel: 117 liter (30.8 US Gal.), less 4 liter (1.05 US Gal.) for warm up and taxi, less 19 liter (5 US Gal.) for a flight reserve of 45 min at 45% power.

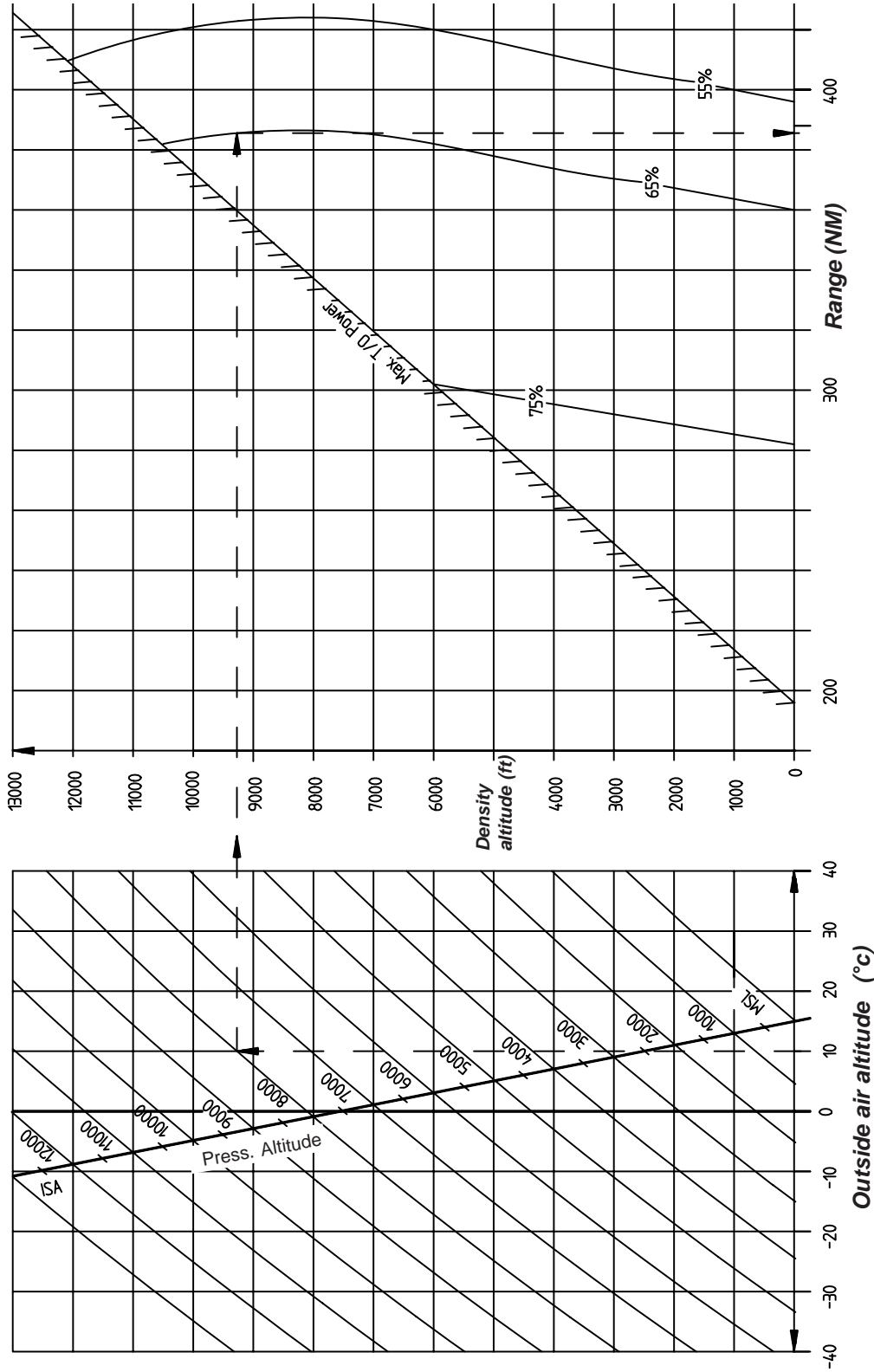

**5.12 CRUISE PERFORMANCE**

Range and Endurance values for a T/O weight of 840 kg (1852 lbs) including fuel for warm-up and takeoff from SL, max. cont. Power climb to cruising altitude, and a reserve of 19 liters (5 US Gal.) for 45 minutes with 45% power. 5 liters (1.3 US Gal.) unusable fuel is taken into account. (At ISA - Conditions.)

PA [ft]	Eng. [RPM]	Manif. Press. [IN HG]	Power Setting		Fuel Consumption		TAS		IAS		Endur. ① [h]	Range ① [NM]	Mixture ② Best ...
			[%]	[Hp]	[l/h]	(gal/h)	[Kts]	(km/h)	[Kts]	(km/h)			
2000	2400	25,0	75	150	46	(12,2)	141	(261)	135	(250)	2,05	288	Power
	2300	23,5	65	130	34	(9,0)	134	(248)	128	(237)	2.75	368	Economy
	2000	23,5	55	110	29	(7,7)	126	(233)	122	(226)	3.21	405	Economy
4000	2400	24,5	75	150	46	(12,2)	145	(269)	135	(250)	2,05	294	Power
	2200	23,8	65	130	34	(9,0)	138	(256)	128	(237)	2.73	374	Economy
	2000	23,1	55	110	29	(7,7)	130	(241)	123	(228)	3.18	412	Economy
6000	2500	23,1	75	150	46	(12,2)	150	(278)	135	(250)	2.05	303	Economy
	2200	23,0	65	130	34	(9,0)	142	(263)	128	(237)	2,71	382	Economy
	2000	22,8	55	110	29	(7,7)	134	(248)	123	(228)	3.15	421	Economy
8000	2350	21,5	65	130	34	(9,0)	146	(270)	128	(237)	2.70	389	Economy
	2050	21,5	55	110	29	(7,7)	138	(256)	122	(226)	3,12	428	Economy
10000	2500	19,9	65	130	35	(9,2)	150	(278)	128	(237)	2.60	380	Economy
	2200	20,0	55	110	30	(7,9)	142	(263)	121	(224)	2.98	416	Economy
12000	2300	18,3	55	110	31	(8,2)	146	(270)	122	(226)	2.85	408	Economy

**NOTE**

① For temperatures above/ below Standard (ISA), increase/decrease Range 1,7% and Endurance 1,1% for each 10°C above/below Standard Day Temperature for particular altitude.

② **Leaning with exhaust gas temperature (EGT) gage**

For the adjustment "**Best Power**", first lean the mixture to achieve the top exhaust temperature (peak EGT) and then enrich again until the exhaust temperature is 100°F lower than peak EGT.

For the adjustment "**Best Economy**", simply lean the mixture to achieve the top exhaust temperature (peak EGT).

**Leaning without exhaust gas temperature (EGT) gage and flowmeter**

Slowly move mixture control from "Full rich" position towards lean position. Continue leaning until slight loss of power is noted (Loss of power may or may not be accompanied by rough engine run). Then enrich until engine runs smoothly and power is regained.

**CAUTION**

Always return the mixture to full rich before increasing power settings.

**5.13 LANDING DISTANCE**

Power: Idle and propeller of full fine

Landing runway: Paved level dry runway

For every 5 kts (9 km/h) headwind, the landing distance (L/D) can be decreased by 10%.

For every 2 kts (4 km/h) Tailwind [up to 10 kts (19 km/h)], the landing distance (L/D) is increased by 10%. On a solid, dry and plain Grass Runway, the landing distance (L/D) is increased by 15%.

**Weight: 700 kg (1543 lbs)** Landing speed at 15m (50ft) : 70 KIAS (130 km/h)  
Landing distance in meter Side slip from 15m (50 ft) down to ca.5 m (15ft)

PA	-20°C OAT		-10°C		0°C		10°C		20°C		30°C		40°C	
	L/D	50 ft	L/D	50 ft	L/D	50 ft	L/D	50 ft	L/D	50 ft	L/D	50 ft	L/D	50 ft
Sea level	150	341	164	371	178	403	192	436	208	471	223	507	240	544
2000	166	377	181	411	197	446	213	483	230	521	247	561	266	603
4000	185	418	201	456	218	495	236	535	255	578	274	622	295	668
6000	205	465	223	506	242	549	262	595	283	642	305	691	327	742
8000	228	517	248	563	269	611	292	661	315	714	339	768	364	825

Landing distance in ft

PA	-20°C OAT		-10°C		0°C		10°C		20°C		30°C		40°C	
	L/D	50 ft	L/D	50 ft	L/D	50 ft	L/D	50 ft	L/D	50 ft	L/D	50 ft	L/D	50 ft
Sea level	492	1119	538	1217	584	1322	630	1430	682	1545	732	1663	787	1785
2000	545	1237	594	1348	646	1463	699	1585	755	1709	810	1841	873	1978
4000	607	1371	659	1496	715	1624	774	1755	837	1896	899	2041	968	2192
6000	673	1526	732	1660	794	1801	860	1952	928	2106	1001	2267	1073	2434
8000	748	1696	814	1847	883	2005	958	2169	1033	2343	1112	2520	1194	2707

**Weight: 840 kg (1852 lbs)** Landing speed at 15m (50ft) : 73 KIAS (135 km/h)  
Landing distance in meter Side slip from 15m (50 ft) down to ca.5 m (15ft)

PA	-20°C OAT		-10°C		0°C		10°C		20°C		30°C		40°C	
	L/D	50 ft	L/D	50 ft	L/D	50 ft	L/D	50 ft	L/D	50 ft	L/D	50 ft	L/D	50 ft
Sea level	194	440	211	479	229	520	248	563	268	608	288	654	310	703
2000	215	487	234	531	254	576	275	623	297	673	319	724	343	778
4000	238	540	259	588	282	639	305	691	329	746	354	803	380	863
6000	265	600	288	653	313	709	338	767	365	828	393	892	422	958
8000	294	667	320	727	348	789	376	854	406	921	437	992	470	1065

Landing distance in ft

PA	-20°C OAT		-10°C		0°C		10°C		20°C		30°C		40°C	
	L/D	50 ft	L/D	50 ft	L/D	50 ft	L/D	50 ft	L/D	50 ft	L/D	50 ft	L/D	50 ft
Sea level	636	1444	692	1572	751	1706	814	1847	879	1995	945	2146	1017	2306
2000	705	1598	768	1742	833	1890	902	2044	974	2208	1047	2375	1125	2552
4000	781	1772	850	1929	925	2096	1001	2267	1079	2448	1161	2635	1247	2831
6000	869	1969	945	2142	1027	2326	1109	2516	1198	2717	1289	2927	1385	3143
8000	965	2188	1050	2385	1142	2589	1234	2802	1332	3022	1434	3255	1542	3494

---

---

SECTION 6

WEIGHT AND BALANCE AND EQUIPMENT LIST

**Table of Contents**

<i>Paragraph</i>		<i>Page</i>
<b>6.1</b>	<b>GENERAL .....</b>	<b>6-3</b>
<b>6.2</b>	<b>AIRCRAFT WEIGHING PROCEDURE .....</b>	<b>6-3</b>
6.2.1	Owners Weight And Balance Record .....	6-4
<b>6.3</b>	<b>CENTER OF GRAVITY CALCULATION (SAMPLE PROBLEM) .....</b>	<b>6-5</b>
6.3.1	Sample .....	6-7
6.3.2	Weight And Balance Record Sheet .....	6-7
<b>6.4</b>	<b>LOADING WEIGHTS AND MOMENTS .....</b>	<b>6-8</b>
<b>6.5</b>	<b>WEIGHTS AND MOMENTS LIMITS .....</b>	<b>6-9</b>
<b>6.6</b>	<b>EQUIPMENT LIST .....</b>	<b>6-10</b>

**Left blank intentionally**

## 6.1 GENERAL

This section describes the procedure for establishing the basic weight and moment of the aircraft. Sample forms are provided for reference. Procedures for calculating the weight and movement for various operations are also provided. A comprehensive list of all equipment available for this aircraft is included. It is the responsibility of the pilot to ensure that the aircraft is loaded properly.

## 6.2 AIRCRAFT WEIGHING PROCEDURE

The aircraft weight is determined by weighing all three wheel loads simultaneously by three scales with the aircraft levelled.

(Upper fuselage reference line horizontal)

Datum line for weight arms  $x$  is the fire wall.

$X_1$  = distance: fire wall - main wheel

$X_2$  = distance: fire wall - tail wheel

$X_N$  = distance: fire wall - item N

$X_G$  = distance: fire wall - Center of Gravity

$W_1$  = Sum of weights indicated by the two scales below the main wheels

$W_2$  = Weight indicated by the scale below the tail wheel

$W$  = Total weight =  $W_1 + W_2$

$X_G = \frac{(W_1 \times X_1) + (W_2 \times X_2)}{W}$  = C.G. position

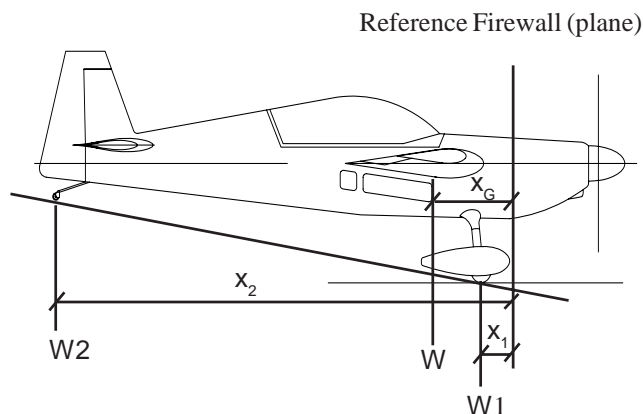

$$W = W_1 + W_2, \quad X_G = \frac{(W_1 \times X_1) + (W_2 \times X_2)}{W}$$



**6.3 CENTER OF GRAVITY CALCULATION (SAMPLE PROBLEM)**

Position	PILOT Rear Seat		ACRO-TANK Fuel 36 Liter (9.5 US GAL)		COPILOT Front Seat		WING-TANK Fuel 86 Liter (22.6 US GAL)	
	(kg)	(lbs)	(kg)	(lbs)	(kg)	(lbs)	(kg)	(lbs)
①	90	198.5	-	-	-	-	-	-
②	90	198.5	25.9	57.1	-	-	-	-
③	90	198.5	25.9	57.1	-	-	62	136.7
④	90	198.5	-	-	65	143.3	-	-
⑤	90	198.5	25.9	57.1	65	143.3	-	-
⑥	90	198.5	25.9	57.1	65	143.3	62	136.7
⑦	90	198.5	-	-	90	198.5	-	-
⑧	90	198.5	25.9	57.1	90	198.5	-	-
⑨	90	198.5	25.9	57.1	90	198.5	62	136.7

**6.3 CENTER OF GRAVITY CALCULATION (SAMPLE PROBLEM)**

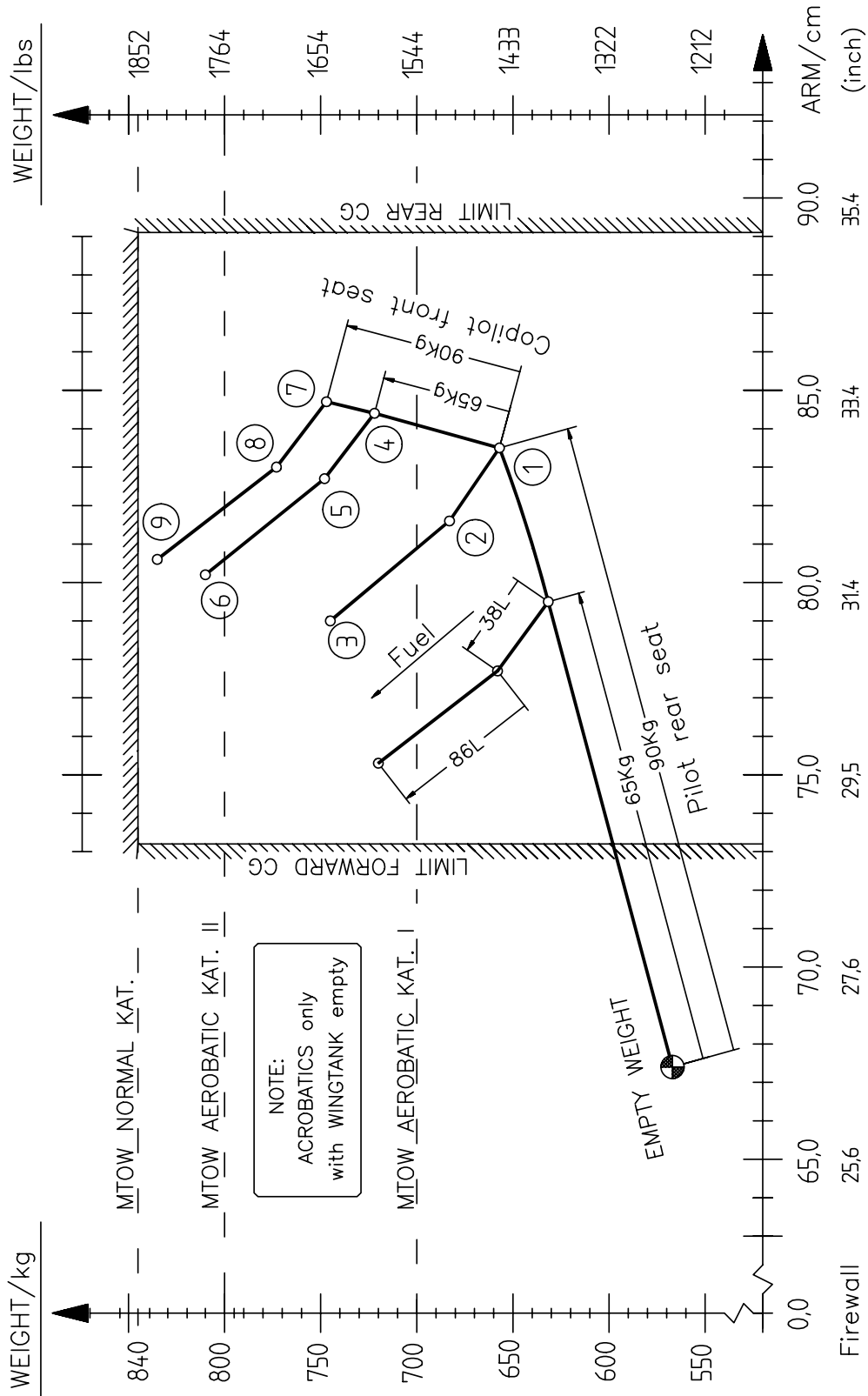

**6.3.1 SAMPLE**

Takeoff Condition:

Pilot On Rear Seat	90.0 kg	( 198.5 lbs)
Copilot On Front Seat	65.0 kg	( 143.3 lbs)
"Acro & Center" Fuel	25.9 kg	( 57.1 lbs)
86 l Fuel In Wing Tanks	62.0 kg	( 136.7 lbs)
Aircraft Empty Weight	567.0 kg	(1250 lbs)
	=====	=====
	809.9 kg	(1785.6 lbs)

To find C.G., follow line "Pilot Rear Seat" from Empty Weight to "90 kg" [198.5 lbs] (Point "1"). Continue on line "Copilot Front Seat" to 65 kg (Point "4"). Now follow line "Fuel" via Point "5" to Point "6":

FIND:      Weight ~ 810 kg      (1785.7 lbs)  
              C.G.    ~ 80.2 cm      (31.5 inch)

**6.3.2 WEIGHT AND BALANCE RECORD SHEET**

	WEIGHT (Kg)	ARM (cm)	MOMENT (Kg cm)
EMPTY WEIGHT:			
PILOT:			
COPILOT:			
"ACRO & CENTER" - FUEL:			
"WING TANK" - FUEL:			
	<b>Σ W =</b>		<b>Σ ( W x X ) =</b>

$$XG = \frac{\Sigma (W \times X)}{\Sigma W} = \text{---} \text{ cm}$$

### 6.4 LOADING WEIGHTS AND MOMENTS

OCCUPANTS : max. 2

WEIGHT Pilot + Parachute		PILOT <u>REAR SEAT</u> Arm = 185cm (73 inch)		COPILOT <u>FRONT SEAT</u> Arm = 93.7 cm (37 inch)	
KG	LBS	KG x CM	(IN x LBS) MOMENT	KG x CM	(IN x LBS)
65	143	12012	(10404)	6091	(5275)
70	154	12936	(11204)	6559	(5681)
75	165	13860	(12005)	7028	(6087)
80	176	14784	(12805)	7496	(6493)
85	187	15708	(13605)	7965	(6898)
90	198	16632	(14406)	8433	(7304)

Fuel in the System: Max. 122 LITERS (32.1 US GAL.)

Fuel					
<u>"ACRO &amp; CENTER" TANK</u>			<u>WINGTANK</u>		
LITER (US GAL)	KG (LBS)	KG x CM (LBS x IN)	LITER (US GAL)	KG (LBS)	KG x CM (IN x LBS)
5 (1.3)	3.6 (8)	126 (109)	10 (2.6)	7.2 (16)	361 (312)
10 (2.6)	7.2 (16)	252 (218)	20 (5.3)	14.4 (32)	721 (625)
15 (4.0)	10.8 (24)	378 (327)	30 (7.9)	21.6 (48)	1082 (937)
20 (5.3)	14.4 (32)	504 (437)	40 (10.6)	28.8 (63)	1443 (1250)
25 (6.6)	18.0 (40)	630 (546)	50 (13.2)	36.0 (79)	1804 (1562)
30 (7.9)	21.6 (48)	756 (655)	60 (15.8)	43.2 (95)	2164 (1875)
36 (9.5)	25.9 (58)	932 (799)	70 (18.5)	50.4 (111)	2525 (2187)
			80 (21.1)	57.6 (127)	2886 (2499)
			86 (22.7)	61.9 (136)	3102 (2687)

**6.5 WEIGHTS AND MOMENTS LIMITS**

**Example:**

At 655 kg and 58000 kgcm the C.G. location is  
87.0 cm aft of ref. datum

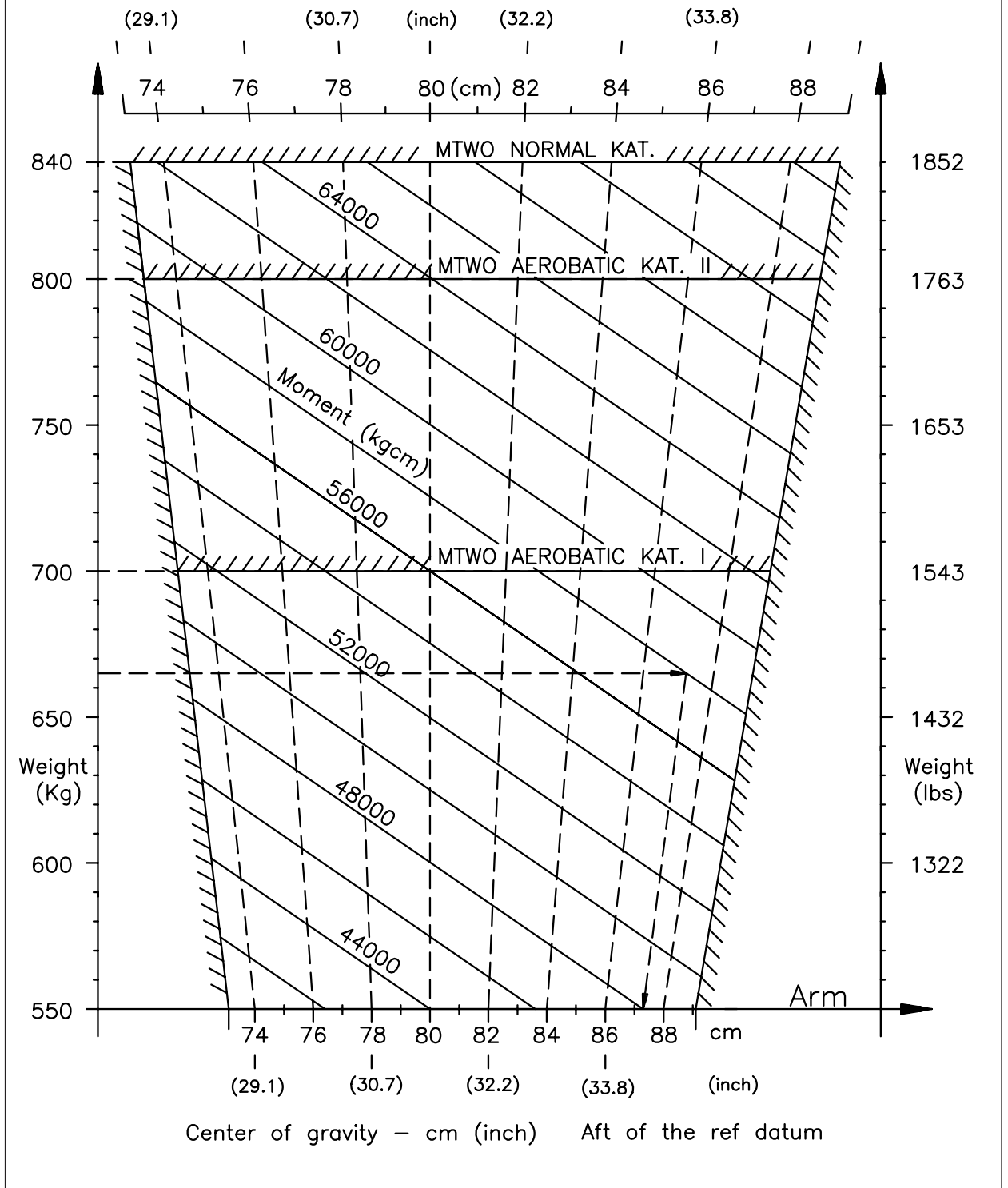

**6.6 EQUIPMENT LIST EXTRA-200 S/N:**

QTY	ITEM	MANUFACT	PART NUMBER	WEIGHT (KG)	ARM (m)	Mark if installed	Required (R) Optional (O) Alternate (A)
1	Engine	Lycoming	AEIO-360-A1E	128.40	-0.51		R
1	Magneto, LH	Slick	4372	2.30	-0.22		R
1	Magneto, RH	Slick	4370	2.00	-0.22		R
4	Shock Mounts	Lord	J-7402-37	1.70	-0.29		R
4	Shock Mounts	Barry Controls	94150-02	1.70	-0.29		A
1	Exhaust System 4 in 1	Gomolzig	EA200-606000	7.35	-0.29		R
1	Exhaust System 4 in 1 with Silencer	Gomolzig	EA200-606000/1	7.90	-0.27		O
1	Starter	Lycoming	MZ 4221	8.15	-0.67		R
1	Starter, lightweight	SKY-TEC (Lycoming)	149-12 LS (31A22 104)	3.65	-0.75		A
1	Fuel Injector	Bendix	RSA-5 AD 1	3.46	-0.57		R
1	Elec. Fuel Pump	Weldon Tool	8120-M	1.10	-0.04		R
1	Elec. Fuel Pump	Weldon Tool	B8120-M	1.10	-0.04		A
1	Fuel Selector	Allen	6 S 122	0.19	0.26		R
1	Oil Cooler	Stewart Warner	8406 R	1.40	-0.77		R
1	Propeller	MT-Propeller	MTV-12-B-C / C183 - 17e	22.90	-1.02		R
1	Spinner	Mühlbauer	P-440				R
1	Governor	Woodward	D 210 982	1.10	-0.79		R
1	Governor	MT-Propeller	P-880-3	1.10	-0.79		A
1	Set Fuel, Oil & Sense Hoses in Eng. Comp.	Aeroquip	Type 303 with Firesleeve AE 102	6.15	-0.21		R
1	Set Fuel Hoses in Cabin Comp.	Aeroquip	Type 303	1.38	0.21		R
1	Sense Hoses (Cabin) (Oil, Fuel & MA Press)	Knapp/Hoerbiger	HS3AM and H3MM	0.30	0.77		R
1	RPM Vernier Control	ACS Products Co.	A-750-30-1200	0.71	0.55		R
1	RPM Vernier Control	ACS Products Co.	A-750-30-960	0.60	0.49		A
1	Mixture Vernier Control	ACS Products Co.	A-750-20-1080	0.65	0.68		R
1	Mixture Vernier Control	ACS Products Co.	A-750-20-960	0.60	0.60		A
1	Throttle Control	Teleflex Marine	F303 02750	0.50	0.60		R
1	Altimeter, front	United Instr.	UI5934PD-3 A.134	0.60	0.52		O
1	Altimeter, front (metric)	Winter	4110	0.33	0.55		O
1	Altimeter, rear	United Instr.	UI5934PD-3 A.134	0.60	1.50		R
1	Altimeter, rear (metric)	Winter	4110	0.33	1.50		A
1	Altitude Blind Encoder	ACK	A-30	0.15	1.26		O
1	Airspeed Indicator, front	Winter	6533 422	0.21	0.52		O
1	Airspeed Indicator, front	United Instr.	UI8030 B.871	0.22	0.52		O
1	Airsp. Ind, front (metric)	Winter	6531 422	0.21	0.52		O
1	Airspeed Indicator, rear	Winter	6533 422	0.21	1.50		R
1	Airspeed Indicator, rear	United Instr.	UI8030 B.871	0.22	1.50		A
1	Airsp. Ind., rear (metric)	Winter	6531 422	0.21	1.50		A

QTY	ITEM	MANUFACT	PART NUMBER	WEIGHT (KG)	ARM (m)	Mark if installed	Required (R) Optional (O) Alternate (A)
1	RPM Indicator	VDO	333 230 115 002 or 333 035 001G	0.31	1.49		R
1	RPM Indicator digital	Horizon	P100-230-464-00	0.68	1.49		A
1	Magnetic Compass	Airpath	C 2300	0.25	1.50		R
1	Accelerometer	Kollsman or Pioneer or Bendix	AN 5745	0.37	1.50		O
1	Accelerometer	EXTRA	DSA 12	0.37	1.49		O
1	Accelerometer	EZE Technologies	DA-55	0.16	1.49		O
1	Turn & Bank Indicator	United Instr.	9501-2 / TSO C3b	0.55	1.50		O
1	Turn & Bank Indicator	Castleberry	C101 / TSO C101T	0.55	1.50		
1	VHF RADIO	Becker	AR 3201	0.90	1.46		R
1	VHF RADIO	Becker	AR 4201	0.90	1.46		A
1	GPS / NAV / COM	Garmin	GNS 430	2.95	1.40		O
1	Transponder	King	KT 76A	0.89	1.40		O
1	Transponder	Garmin	GTX 327	0.95	1.40		O
1	Transponder	Filser	TRT-600 (LAST)	0.70	1.45		O
1	Transponder	Filser	TRT-800	0.70	1.45		O
1	Transponder	Garmin	GTX 330	1.50	1.40		O
1	Transponder	Bendix/King	KT 73	1.64	1.40		O
1	Transponder	Becker	BXP6401-1	0.80	1.45		O
1	Transponder	Becker	BXP6401-2	0.80	1.45		O
1	Transponder	Becker	ATC-2000	1.20	1.40		O
1	Transponder	Becker	ATC-4401	0.73	1.45		O
1	Transponder Antenna	Comant Industries	CI 105	0.11	0.08		O
1	Transponder Antenna	Bendix/King	KA 60	0.11	0.08		O
1	COM Antenna	Moba	210FA	0.10	4.02		R
1	COM Antenna	EXTRA	83205A	0.10	4.02		A
1	COM Antenna	Pointer	P1 3001-10	0.05	4.02		A
1	ELT	Pointer	3000-10	1.00	2.60		O
1	Oil-Press. Indicator	UMA	3-311-32 or 10-12400	0.05	1.52		R
1	Oil Press./Oil Temp Ind.	Amitek or Christen	61943	0.51	1.52		A
1	Oil Temp. Indicator	Westach	2A9-2	0.05	1.52		R
1	Oil Temp Sensor	Westach	W399-S9	0.08	-0.20		R
1	Oil Press./ Oil Temp. Ind. (3 1/8")	Westach	3DA3-3MM or 3DA3-3KV	0.14	1.50		A
1	Oil Temp. Sender	Westach	W399-S9	0.08	-0.20		A
1	Oil Press Sensor	Westach	387-100MM or 387-100KV or 387-11MM	0.12	0.04		A
		or Mediamate	9308704	0.12	0.04		A
1	Oil Press / Oil Temp Ind. (2 1/4")	Westach	2DA3-3MM or 2DA3-3KV	0.09	1.50		A
1	Oil Temp. Sender	Westach	W399-S9	0.08	-0.20		A
1	Oil Press Sensor	Westach	387-100MM or 387-100KV or 387-11MM	0.12	0.04		A
		or Mediamate	9308704				

QTY	ITEM	MANUFACT	PART NUMBER	WEIGHT (KG)	ARM (m)	Mark if installed	Required (R) Optional (O) Alternate (A)
1	EGT/CHT Indicator	Westach	2 DA 1	0.07	1.52		O
1	EGT Probe	Westach	712-2 DWK	0.06	-0.46		O
1	CHT Probe	Westach	712-7 DK	0.05	-0.50		O
1	Manifold press. Indicator	UMA	7-100-20	0.13	1.52		R
1	Fuel Pressure Ind.	UMA	3-313-10	0.05	1.52		R
1	Man Press / Fuel Press	United Instr.	UI6331 H.52	0.54	1.50		A
1	Man Press / Fuel Flow	United Instr.	UI6331 H.212	0.54	1.50		A
1	Fuel Cont. Probe Wing (Wing Tank)	VDO	226 801 015 001 G	0.12	0.51		R
1	Fuel Cont. Ind. Wing (Wing Tank)	VDO	301 271 036 001 K or 301 030 001 G	0.08	1.50		R
1	Fuel Cont. Probe Acro & Center Tank	VDO	224 082 006 097 R	0.20	0.36		R
1	Fuel Cont. Ind. Acro & Center Tank	VDO	301 272 052 001 K or 301 030 002 G	0.14	1.50		R
1	Ammeter	VDO	190 004 039 002 or 190 037 002 G	0.08	1.50		R
1	Volt/Ammeter	Electronics Intern.	VA-1A	0.26	1.51		A
1	Volt/Ammeter	Electronics Intern.	VA-1A-50	0.22	1.50		A
1	Shunt	Electronics Intern.	S-50	0.09	1.40		A
1	Alternator 60Amp	Electrosystems	ALX 8421 LS	5.90	-0.69		R
1	Voltage Regulator	Lamar	B-00371-25	0.15	0.02		R
1	Low Vol. Monitor	Lamar	B-00378-4	0.03	0.02		R
1	Alternator 65 Amps	Bosch	0 120 489 935	4.60	-0.72		A
1	Alternator 55 Amps	Bosch	0 120 489 917	4.20	-0.72		A
1	Alternator 55 Amps	Bosch	0 120 489 469	4.20	-0.72		A
1	Battery	Sonnenschein	DRYFIT A212/24G	8.60	-0.11		R
1	Battery	Hagen	HDSM-12250	9.70	-0.11		A
1	Battery	Exide/Sonnenschein	Dryfit A512/25G5	9.65	-0.11		A
1	Battery	B&C	BC100-MJ	11.29	-0.11		A
1	Batt. Charger Plug	EXTRA	146 19 20	0.02	0.26		O
1	External Power Recept.	Diverse	AN 2552-3A	1.46	1.77		O
1	Ext. Power Solenoid	Switches Kidde	22735	0.40	-0.03		O
1	Ext. Power Solenoid (cont. operation)	White-Rodgers	70-111-225-5	0.40	-0.03		O
1	Main Bus Solenoid	White-Rodgers	70-111-226-5	0.40	-0.03		R
1	Starter Solenoid	Switches Kidde	22735	0.40	-0.03		R
1	Ignition switch	TCM	10-357200-1	0.15	1.50		R
1	Main Bus Fuseholder	MTA	PN 03.00360	0.03	-0.01		O
1	Main Bus Strip Fuse (40 Amps)	MTA	PN 02.00300		-0.01		O
1	PCB Auto Fuse	EXTRA	83290.1	0.01	-0.03		O
1	Low Voltage Light	OAK	MS 25041-2	0.02	1.53		R
1	Switches	Cutler Hammer	div.	0.04	1.52		R
3	Circuit Breakers	Potter&Brumfield	div.	0.14	1.51		R
5	Switch/Circuit Breakers	Potter&Brumfield	div.	0.25	1.51		R

QTY	ITEM	MANUFACT	PART NUMBER	WEIGHT (KG)	ARM (m)	Mark if installed	Required (R) Optional (O) Alternate (A)
1	Strobe Light (single)	Whelen	A 470-W	0.13	0.85		R
1	Strobe Power Supply	Whelen	A490 T	0.27	0.85		R
2	Strobe/Nav LTS (RH/LH)	Whelen	A 600-PG/PR-14	0.23	0.80		A
2	Strobe Power Supply	Whelen	A 490 T	0.54	0.80		A
1	Stall Sensor	EXTRA	73106.1	0.07	0.42		R
1	Stall Warn Horn	EMAG	EM-S 110P	0.13	1.37		R
2	Main Wheel Tires	Diverse	5.00-5 / 6PR	3.90	0.35		R
2	Main Wheel Rim	Cleveland	40 - 151	4.00	0.35		R
2	Brake Assy	Cleveland	30 - 164	1.40	0.35		R
2	Brake Cylinder front	Cleveland	10 - 20 E	0.55	0.15		R
2	Brake Cylinder rear	Cleveland	10 - 20 E	0.55	0.95		R
2	Brake Cylinder front	Matco	MC4E	0.55	0.15		A
2	Brake Cylinders rear	Matco	MC4E	0.55	0.95		A
1	Tail Wheel 5"	EXTRA	steerable	5.50	4.70		A
1	Tail Wheel 6" Assy (Soft)	Special Products Aviation Inc.		5.90	4.70		A
1	Brake Fluid Reservoir	ACS	A-315	0.20	-0.04		R
1	Safety Belt Assy. Front	Hooker	1 013 030	2.90	1.10		R
1	Safety Belt Assy. Front	Hooker	1 011 230 With Ratchet	3.30	1.80		A
1	Safety Belt Assy. Rear	Hooker	1 011 230 With Ratchet	3.30	1.80		R
1	Standard Canopy	EXTRA	27301.000-LV	11.00	1.45		R
1	Single Seat Canopy	EXTRA	87410.000-LV	9.20	1.45		O
1	Long Range Tank	EXTRA	87901	1.80	0.62		O
1	Leather Interior	EXTRA	Assy	1.50	1.55		O
1	Aresticard Holder	EXTRA	Assy	0.09	1.51		O
1	Airtow Hook	EXTRA/TOST	83607A0	0.50	5.05		O
1/2	Sighting Device LH/RH	EXTRA	84801.10	each 0.44	1.53		O
2	Wing Tie Down Rings	EXTRA	83801.2-01	0.04	1.18		O
1	Rear Seat Pan Stand.	EXTRA	77201.4	1.40	1.94		R
1	Rear Seat Pan Adjust.	EXTRA	87403.1	1.40	1.94		A
1	Horizontal Tail Standard	EXTRA	37201.1	20.00	4.24		R
1	Horizontal Tail (CRP)	EXTRA	87932	19.00	4.25		A
1	Vertical Tail Standard	EXTRA	37101.1	9.80	4.54		R
1	Vertical Tail (CRP)	EXTRA	87931	9.00	4.54		A

**Left blank intentionally**

---

---

SECTION 7

DESCRIPTION AND OPERATION  
OF AIRCRAFT AND SYSTEMS

Table of Contents

<i>Paragraph</i>		<i>Page</i>
<b>7.1</b>	<b>THE AIRCRAFT .....</b>	<b>7-3</b>
<b>7.2</b>	<b>FUSELAGE .....</b>	<b>7-3</b>
<b>7.3</b>	<b>WINGS .....</b>	<b>7-4</b>
<b>7.4</b>	<b>EMPENNAGE .....</b>	<b>7-4</b>
<b>7.5</b>	<b>FLIGHT CONTROL SYSTEM .....</b>	<b>7-5</b>
7.5.1	Primary Control System .....	7-5
7.5.2	Longitudinal Flight Control System .....	7-5
7.5.3	Lateral Flight Control System .....	7-5
7.5.4	Directional Flight Control System .....	7-5
7.5.5	Secondary Control .....	7-5
<b>7.6</b>	<b>INSTRUMENTATION .....</b>	<b>7-6</b>
7.6.1	Instrument Panel (Rear Cockpit) .....	7-6
7.6.2	Instrument Panel (Front Cockpit) .....	7-8
<b>7.7</b>	<b>LANDING GEAR .....</b>	<b>7-8</b>
<b>7.8</b>	<b>SEATS, SEAT BELTS .....</b>	<b>7-9</b>
<b>7.9</b>	<b>CANOPY .....</b>	<b>7-9</b>
<b>7.10</b>	<b>POWER PLANT .....</b>	<b>7-10</b>
7.10.1	Engine .....	7-10
7.10.2	Oil System .....	7-11
7.10.3	Engine Installation .....	7-11
7.10.4	Propeller .....	7-11
7.10.5	Throttle .....	7-11
7.10.6	Mixture .....	7-11
7.10.7	RPM-Control .....	7-11
7.10.8	Fuel Selector Valve .....	7-12
7.10.9	Exhaust System (optional) .....	7-12
<b>7.11</b>	<b>FUEL SYSTEM .....</b>	<b>7-12</b>
<b>7.12</b>	<b>ELECTRICAL SYSTEM .....</b>	<b>7-13</b>
<b>7.13</b>	<b>CABIN ENVIRONMENT CONTROL .....</b>	<b>7-15</b>

**Left blank intentionally**

## SECTION 7

### DESCRIPTION AND OPERATION OF AIRCRAFT AND SYSTEMS

#### 7.1 THE AIRCRAFT

The aircraft EXTRA 200 is designed and developed by EXTRA Flugzeugproduktions- und Vertriebs- GmbH, Dinslaken 46569 Hünxe, Federal Republic of Germany, in accordance with the U.S. Federal Aviation Regulations, part 23, categories normal and acrobatic to fulfil the primary flight training, normal operation rules and acrobatic training up to the unlimited acrobatic level.

EXTRA 200 is a light weight, robust, single piston-engined, two-seat aircraft with a fuselage structure in tig-welded steel-tube construction.

The landing gear, wing, and tail are made of epoxy, reinforced with glass- and carbonfiber. The items are qualified up to 72°C (161,6°F). Not to exceed this temperature limit an appropriate colour specification for composite structure is given by the manufacturer document EA-03205.19.

To check the temperature inside the cockpit (potential "green house" effect) a reversible temperature indicator (*STRUCTURAL OVERHEAT INDICATOR*) is applied on the upper side of the wing main spar in the carry-through section. After reaching the temperature limit of 72°C (161,6°F) the word "*RISK*" appears on the red spot of this structural overheat indicator immediately and flying is prohibited. When the structure cools down below this temperature limit the word "*RISK*" disappears and you may go on with the preflight checklist.

a) Below 72°C (161,6°F)



b) At 72°C (161,6°F) or above



The standard aircraft is designed to operate within a range of ambient air temperature from -20°C to +44°C (-4°F to 111°F) at sea level. It is possible to start the engine using the aircraft battery at -20°C (-4°F) without preheating. Below -10°C (+14°F) OAT a special oil breather line must be adapted (available as kit).

#### 7.2 FUSELAGE

The fuselage structure consists of a steel tube construction integrating the wing and empennage connections as well as the seats. The fuselage except the rear lower part, is faired with an aramid/carbon laminate shell. Within the exhaust area stainless steel sheet metal is used. The upper fuselage body surface is one part from firewall to vertical stabilizer including the correlated canopy frame. Only the lower rear part of the fuselage is covered with Ceconite® 102.

The canopy frame itself is constructed by carbon laminate. The canopy is one part, opens to the right and is held in the open position by a belt. Emergency jettisoning is achieved by simply unlatching the canopy. For additional pilots protection a roll bar is installed behind the rear pilots seat.

### **7.3 WINGS**

The wing is of CRP construction. The dual chamber main spar - fulfilling the requirement for fail safe design - consists of carbon roving caps combined with CRP webs. Core foam is a PVC foam (Divinycell HT 50). The wing shell is built by a Honeycomb sandwich with CRP Laminates. On the surface there is a protective layer of GRP. To prevent buckling of the shell plywood ribs are used. In the area of the wingtanks is a layer of CRP laminate with an incorporated aluminium thread bonded to the metal fuselage structure as means of lightning protection.

The connection to the fuselage is arranged by two bolts piercing through the spar parallel to the centerline of the fuselage and two brackets at the rear spars. Integral fuel cells are provided in the leading edge of the wing extending from the root ribs to half the span of each R/L and L/H wing. The ailerons are supported at three points in spherical bearings pressed into aluminium brackets. To reduce pilot's hand forces the hinge line of the ailerons is positioned 25% of the aileron depth at the root and 21,5% at the tip. Furthermore the ailerons are equipped with "spades" to decrease pilot forces. Ailerons are controlled via the center bracket. To prevent flutter the ailerons are weight balanced in the overhanging leading edge.

### **7.4 EMPENNAGE**

The EXTRA 200 possesses a cruziform empennage with stabilizers and moveable control surfaces. The rudder is balanced aerodynamically at the tip. Spars consist of PVC foam cores, CRP caps and GRP laminates. The shell is built by honeycomb sandwich with GRP laminates. Buckling is prevented by plywood ribs.

Deviating from the other control surfaces the spar webs of the surfaces of the elevator is built by CRP. On the R/H elevator half a trim tab is fitted with two hinges. The control surfaces are mounted in spherical bearings (exception: Trim tab). To prevent flutter rudder and elevator are mass balanced. The balance weight for the rudder is installed in the rudder tip while the balance weight for the elevator is mounted on the elongated center bracket of the elevator extending into the fuselage.

## **7.5 FLIGHT CONTROL SYSTEM**

### **7.5.1 PRIMARY CONTROL SYSTEM**

The EXTRA 200 is standard equipped with full dual primary flight controls including conventional stick-type control columns and adjustable rudder pedals. The primary control surfaces are operated through a direct mechanical linkage.

### **7.5.2 LONGITUDINAL FLIGHT CONTROL SYSTEM**

The two control columns are interconnected by a torque tube. The control movements are from there transferred to the elevator by a push rod.

### **7.5.3 LATERAL FLIGHT CONTROL SYSTEM**

Push and pull rods are connected by sealed ball bearings from the torque tube to the ailerons.

The ailerons are statically as well as dynamically balanced. (Dynamically with spades).

The ailerons are supported by lubricated, sealed bearings.

### **7.5.4 DIRECTIONAL FLIGHT CONTROL SYSTEM**

The dual rudder pedals with brake pedals are adjustable and operate the rudder through a cable system. Springs keep the cables under tension when they are not operated.

### **7.5.5 SECONDARY CONTROL**

The elevator trim control is located on the right side in the rear cockpit.

The canopy lock is operated from the outside by a handle on left side of the canopy by reaching into the cockpit through the window. Inside a handle is located in both cockpits, used for locking as well as for normal operation and for emergency release.

The starter/magneto switch is located on the left side of the instrument panel in front of the rear seat.

## 7.6 INSTRUMENTATION

The EXTRA 200 is equipped with flight instruments in both cockpits.

Instruments and placards can be provided with markings in either metric or English units. The colour markings in instruments follow US-FAR, part 23 recommendation ( see section 2 ).

### 7.6.1 INSTRUMENT PANEL (REAR COCKPIT)

For instrument panel arrangement of the rear cockpit refer to Fig. 7.6.1, which includes standard and optional equipment marked as such.

Fig. 7.6.1:

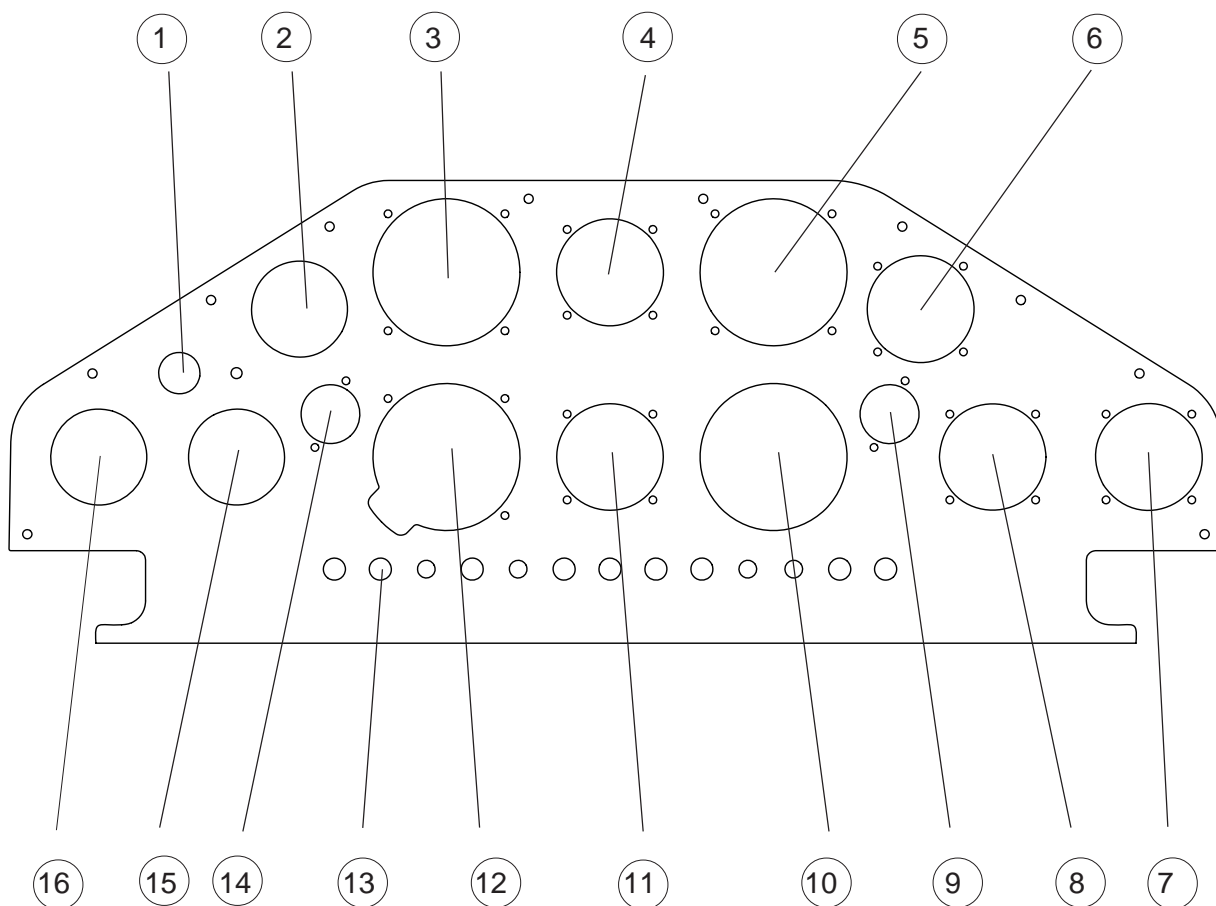

Standard	Optional	Position	Item
x		1	Magneto Selector switch & starter
x		2	Amperemeter
x		3	Airspeed indicator
x		4	Magn. Direction indicator
	x	5	g-meter
	x	6	EGT / CHT
	x	7	COM
x		8	Oil temperature
x		9	Oil pressure
x		10	RPM indicator
x		11	Manifold pressure
x		12	Altimeter
x		13	Switches / Circuit breaker
x		14	Fuel pressure
x		15	Fuel Quantity "Acro & Center" Tank
x		16	Fuel Quantity "Wing Tank"
	x	17	Vertical speed indicator
	x	18	Turn and bank indicator
	x	19	Artificial horizon
	x	20	Intercom button
	x	21	Directional gyro
x		22	RPM control, Prop governor
x		23	Mixture control
x		24	Throttle lever
x		25	Stick
x		26	Radio button
x		27	Fuel shutoff valve
x		28	Trim lever and indicator
x		29	Boost pump

**NOTE**

This list may be modified by the minimum equipment requirements of individual certifying authorities!

### 7.6.2 INSTRUMENT PANEL (FRONT COCKPIT)

The front instrument panel respectively the front cockpit is equipped with the following positions.

24	Throttle
25	Stick
27	Fuel shutoff valve

The following equipment is optional:

3	Airspeed indicator
4	Magn. Direction indicator
5	g-meter
10	RPM indicator
12	Altimeter
17	Vertical speed indicator
18	Turn and bank indicator
19	Artificial horizon
20	Intercom button
21	Directional gyro
26	Radio button

### 7.7 LANDING GEAR

The landing gear is a composite construction with a multichamber fibreglass spring in a tail-wheel design.

The main wheels have a size of 5-5.50 and they are equipped with hydraulic disc brakes.

The tail wheel has a solid rubber tire with full-swivel capability.

## **7.8 SEATS, SEAT BELTS**

The seats are ergonomically shaped composite designs. The back rest is adjustable on the ground with 2 quickpins in different positions and angle. The rear pedal-to-seat distance can be varied in different positions. In the front cockpit there is no possibility to adjust either the pedals nor the seat. The seat belt assembly consists of a left and a right shoulder strap, two left and two right lap belts and a negative-g-strap. All belts are adjustable. As each lap belt features a single point release, they are redundant for safety during aerobatics maneuvers. If one release is opened unintentionally, the second one guarantees full safety. For safe operation the releases are arranged in a way that one has to be closed to the right side, the other one to the left. During acrobatic maneuvers the seat belt system should be tightened firmly.

## **7.9 CANOPY**

The canopy of front and rear cockpit is manufactured in one section. The canopy can be manually operated and opened by lifting to the right. In the open position there is a rod mounted to the fuselage rear of the canopy which must be connected to the canopy preventing slam down unintentionally. Interior canopy locking handles, located on the left side on the canopy of each cockpit must be pulled together to unlock the canopy from the inside. To open the canopy from the outside there are no separate handles, this means it must be opened by reaching through the small window (bad weather window) and proceed as mentioned above (interior opening).

---

## 7.10 POWER PLANT

### 7.10.1 ENGINE

The power plant consists of one Textron-Lycoming six-cylinder, horizontally opposed, air-cooled, direct drive, fuel injection engine type with inverted oil system.

The rated maximum T/O Power is 200 HP at 2700 RPM.

Engine specification:

*Textron-Lycoming AEIO-360-A1E*

For the present TBO refer to latest issue of Textron - Lycoming SERVICE LETTER No. L 201.

The following accessories are included in the power plant installation:

Fuel Injector:	Bendix
Magnetos:	Slick
Alternator:	Electrosystems
Starter:	Lycoming
Fuel pump:	Gates Lear
Shielded ignition system	
Propeller governor drive	
Transistor voltage regulator	
Overvoltage relay	

The engine is operated with the following manual controls:

Throttle control, dual  
RPM control  
Fuel mixture control

The propeller governor monitors the RPM automatically and prevents overspeeding. In the event that oil pressure is lost the propeller is automatically adjusted to coarse pitch in order to avoid overspeeding.

The use of 100/100LL aviation grade fuel (AVGAS 100) is the minimum grade recommended by the manufacturer of the AEIO-360-A-1E engine.

For continuous operation 115/145 aviation fuel is the maximum grade.

### **7.10.2 OIL SYSTEM**

The oil is cooled by an oilcooler mounted on the left hand side in the engine compartment. The oil level is determined by a dip-stick.

A thermostatic valve is fitted upstream of the oil cooler. This valve ensures a quick warm-up of the oil after engine start.

Oil capacity and grades:

Oil:

Max sump capacity		8 qts.
Min sump capacity	Acrobatic	6 qts.
	Normal	4 qts.

For temperatures and oil grades refer to Section 1.7.

### **7.10.3 ENGINE INSTALLATION**

The engine is supported by four shock mounts (type LORD or BARRY CONTROLS), to the tig-welded steel tube engine mount which is attached to the fuselage with four bolts on the firewall axis.

The engine cowling is divided into two parts, a lower and an upper part both made of glass-fibre/carbonfibre reinforced epoxy. The parts are fixed by a number of screws and the upper cowling has a separate hatch for easy access to the oil dip-stick.

### **7.10.4 PROPELLER**

The standard propeller is a 3-blade wood composite, constant speed propeller type MTV-12-B-C/C183-17e. The propeller has a diameter of 1,83 m.

### **7.10.5 THROTTLE**

Dual control (cub-type) mounted on the left side in cockpit.

### **7.10.6 MIXTURE**

Vernier-control located at left side of rear cockpit (red knob).

### **7.10.7 RPM-CONTROL**

Vernier-control on the left side of the rear cockpit.

Preselection of RPM possible due to constant speed governor (blue knob).

### 7.10.8 FUEL SELECTOR VALVE

Dual control. A rotary fuel selector valve is mounted behind the firewall on the right side of the fuselage. A torque tube connects the valve to both cockpit handles. Pull and turn the handle 90° to open the valve to the Acro & Center tank. A further 90° turn switches to the Wing tank fuel supply.

Position down: "OFF"  
Position left: "ACRO & CENTER"  
Position up: "WING TANK"

### 7.10.9 EXHAUST SYSTEM (OPTIONAL)

The EXTRA 200 can be equipped with a complete 4 in 1 System including silencer.

### 7.11 FUEL SYSTEM

The fuel system consists of two separate, independent tanks:

- "Acro & Center tank" in the fuselage
- "Wing tank" in the wing

#### **Wing tank:**

The root section of each wing in front of the main spars forms an integral fuel tank providing two interconnected tanks with 86 liters (22.7 US Gal.) total capacity. Each side of the wing has a 2" diameter filler cap for gravity refuelling. Due to the interconnection the fuel level of the left and right integral tank will equalize during refuelling within reasonable time. For max. fuel capacity, the first filled side have to be filled once again! Furthermore the wing tank is connected directly to the engine by the fuel selector valve. Unusable fuel is approximately 1 liter (0.3 Us Gal.).

#### **Acro & center tank:**

The Acro tank of 9 liters (2,3 US Gal.) is mounted under the Center tank. This Center tank of 27 liters (7.1 US Gal.) is mounted in front of the main spar of the wing. The Acro tank is connected with the Center tank in a gravity feed system. The Center tank has a 2" diameter filler cap for gravity refuelling. Unusable fuel is approximately 4 liters (1.1 US Gal.)

Adequate venting is provided in each tank by a main ventilation-tube, ending outside the fuselage at the right side.

#### **Fuel pump**

In addition to the engine driven fuel pump an electrically driven auxiliary fuel pump (boost pump) with by-pass, having sufficient capacity to feed the engine at takeoff power, is fitted as a safety device against failure of the engine-driven pump. The boost pump switch is located on the instrument panel.

A fuel filter with drain is installed between the fuel selector valve and the boost pump. Separate drains are located at the lowest point of each tank system.

Normal float type transducers and electrically operated fuel indicators are used.

## 7.12 ELECTRICAL SYSTEM

The electrical system is supplied by a 12 V alternator with rectifier, transistor voltage regulator. The alternator is mounted on and driven by the engine.

The field current is controlled by the voltage regulator to nominal 13.8 V under all load conditions. The masterswitch is located on the rear instrument panel.

Circuit protection against overvoltage is provided by the voltage regulator.

The maximum load taken from the alternator is 40 amp.

A 12 V leak proof battery is connected across the alternator output to stabilize the supply and to maintain all essential services in the event of an alternator failure and when the engine is not operating. The battery is mounted behind the firewall.

All electrical circuits are protected by circuit breakers located on the rear instrument panel and they are easily accessible to the pilot during flight.

The electrical system is adequately noise suppressed to ensure satisfactory operation of the radio equipment.

All wires, switches, circuit breakers etc. are manufactured to related aeronautical specifications.

Standard Equipment shown only

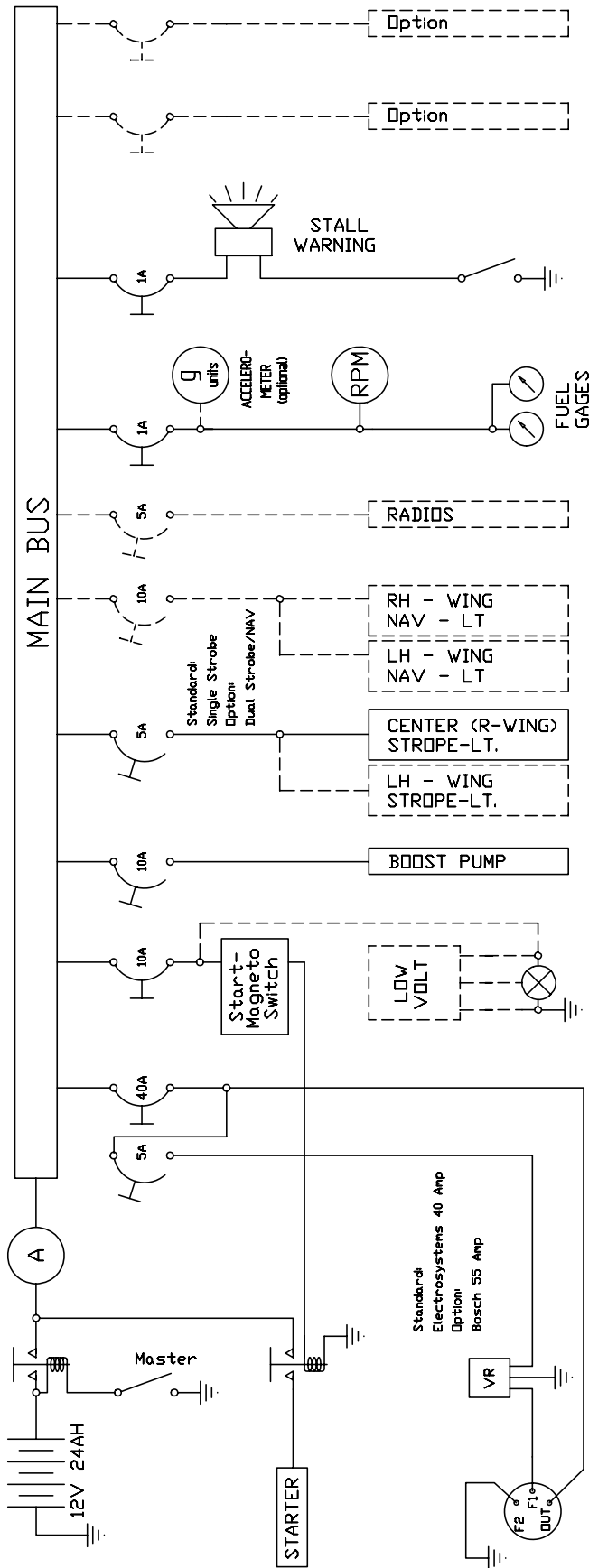

### **7.13 CABIN ENVIRONMENT CONTROL**

A ventilation system in the canopy on the left side is provided for the supply of fresh air to the cabin. Left and right at the rear seat are eyeball-type adjustable vents.

**Left blank intentionally**

**SECTION 8**

**HANDLING, SERVICING AND MAINTENANCE**

**Table of Contents**

<i>Paragraph</i>		<i>Page</i>
<b>8.1</b>	<b>INTRODUCTION .....</b>	<b>8-3</b>
<b>8.2</b>	<b>AIRPLANE INSPECTION PERIODS .....</b>	<b>8-3</b>
<b>8.3</b>	<b>PILOT CONDUCTED PREVENTIVE MAINTENANCE .....</b>	<b>8-3</b>
<b>8.4</b>	<b>ALTERATIONS OR REPAIR .....</b>	<b>8-3</b>
<b>8.5</b>	<b>SERVICING .....</b>	<b>8-4</b>
<b>8.6</b>	<b>GROUND HANDLING .....</b>	<b>8-4</b>

**Left blank intentionally**

## **SECTION 8**

### **HANDLING, SERVICING AND MAINTENANCE**

#### **8.1 INTRODUCTION**

- a) The airplane owner should establish contact with the dealer or certified service station for service and information.
- b) All correspondence regarding the airplane must include its serial number which is stamped on a plate on the L/H rear part of the fuselage.
- c) A service manual with revision service may be procured from the manufacturer.

#### **8.2 AIRPLANE INSPECTION PERIODS**

As required by national operating rules all airplanes must pass a complete annual inspection every twelve calendar months. In addition to the annual inspection airplanes must pass a complete inspection after every 100 flights hours with a minor check after 50 hours.

The Airworthiness Authority may require other inspections by the issuance of airworthiness directives applicable to the aircraft, engine, propeller and components. The owner is responsible for compliance with all applicable airworthiness directives and periodical inspections.

#### **8.3 PILOT CONDUCTED PREVENTIVE MAINTENANCE**

Pilots operating the airplane should refer to the regulations of the country of certification for information of preventive maintenance that may be performed by pilots. All other maintenance required on the airplane is to be accomplished by appropriately licensed personnel. Airplane dealer should be contacted for further information

Preventive maintenance should be accomplished with the appropriate service manual.

#### **8.4 ALTERATIONS OR REPAIR**

Alterations or repairs of the airplane must be accomplished by licensed personnel.

## **8.5      SERVICING**

In addition to the airplane inspection periods (8.2) information for servicing the aircraft with proper oil and fuel is covered in Section 2 (Limitations) and Section 7 (Descriptions and Operation).

## **8.6      GROUND HANDLING**

a) Due to its low weight and the free swivelling tail wheel two persons can easily move the airplane by hand.

b) To tie down the airplane M6 nut plates are provided in the wing tips where ring bolts can be screwed in. The tail wheel leg can be used as third point to tie down the airplane. If the aircraft is parked in the open, it must be protected against the effects of weather, the degree of protection depending on severity of the weather conditions and the expected duration of the parking period. When the airplane is parked in good weather conditions for less than a half day park the aircraft headed into the wind and place wheel chocks at the main wheels.

c) To level the aircraft, the tail wheel is rested on a balance and jacked to a position that the fuselage reference line (upper fuselage stringer tube) is horizontal. There are two engine hoists provided on the top of the engine which can be used to lift the airplane with a crane. (Tail wheel resting on ground)

---

---

**SECTION 9**

**SUPPLEMENTS**

Doc-No. EA-07701.1

**Table of Contents**

Section		Pages
<b>9</b>	<b>Supplements .....</b>	<b>4 p.</b>
<b>9.2</b>	<input type="checkbox"/> <b>(Valid for SN 01 - 02 only) .....</b>	<b>10 p.</b>
<b>901</b>	<input type="checkbox"/> <b>Steerable Tail Wheel .....</b>	<b>4 p.</b>
<b>902</b>	<input type="checkbox"/> <b>Reserved .....</b>	<b>0 p.</b>
<b>903</b>	<input type="checkbox"/> <b>Electronic Accelerometer .....</b>	<b>8 p.</b>
<b>904</b>	<input type="checkbox"/> <b>Emergency Locator Transmitter .....</b>	<b>10 p.</b>
<b>905</b>	<input type="checkbox"/> <b>External Power .....</b>	<b>6 p.</b>
<b>906</b>	<input type="checkbox"/> <b>Digital RPM Indicator .....</b>	<b>6 p.</b>
<b>907</b>	<input type="checkbox"/> <b>Long Range Wing Tank Capacity .....</b>	<b>6 p.</b>
<b>908</b>	<input type="checkbox"/> <b>Airtow Hook .....</b>	<b>8 p.</b>
<b>909</b>	<input type="checkbox"/> <b>Reserved .....</b>	<b>0 p.</b>
<b>910</b>	<input type="checkbox"/> <b>Reserved .....</b>	<b>0 p.</b>
<b>911</b>	<input type="checkbox"/> <b>Single Seat Canopy .....</b>	<b>4 p.</b>
<b>912</b>	<input type="checkbox"/> <b>FILSER TRT 600 Transponder .....</b>	<b>8 p.</b>
<b>913</b>	<input type="checkbox"/> <b>FILSER TRT 800 Transponder .....</b>	<b>8 p.</b>
<b>914</b>	<input type="checkbox"/> <b>GARMIN GTX 327 Transponder .....</b>	<b>6 p.</b>
<b>915</b>	<input type="checkbox"/> <b>GARMIN GTX 330 Transponder .....</b>	<b>8 p.</b>
<b>916</b>	<input type="checkbox"/> <b>BENDIX/KING KT 76A Transponder .....</b>	<b>6 p.</b>
<b>917</b>	<input type="checkbox"/> <b>BENDIX/KING KT 73 Transponder .....</b>	<b>8 p.</b>
<b>918</b>	<input type="checkbox"/> <b>BECKER ATC 2000 Transponder .....</b>	<b>6 p.</b>
<b>919</b>	<input type="checkbox"/> <b>BECKER ATC 4401 Transponder .....</b>	<b>8 p.</b>
<b>920</b>	<input type="checkbox"/> <b>BECKER BXP 6401 Transponder .....</b>	<b>10 p.</b>

**Left blank intentionally**

---

## 9 SUPPLEMENTS

### 9.1 INTRODUCTION

Section 9 "Supplements" of the Pilot's Operating Handbook contains all information, necessary for a safe and efficient operation of the airplane when equipped with one or more of the various optional systems and equipment not provided with the standard airplane.

### 9.2 NOTES

The described systems and equipment are certified by the LBA for the *EXTRA 200*. Pages and contents of this section may not be exchanged and alterations of or additions to the approved contents may be made without the EXTRA Flugzeugproduktions- und Vertriebs-GmbH/LBA approval. The editor has the copyright of this Supplements and is responsible for edition of revisions. The log of effective pages is found under section 0.4 of this Pilot's Operating Handbook.

Each Supplement section (e.g. steerable tailwheel) covers only a single system, device, or piece of equipment and is a self-contained, miniature Pilot's Operating Handbook. The owner is responsible for incorporating prescribed amendments and should make notes about these on the records of amendments. It is responsibility of the pilot to be familiar with the contents of relevant supplements.

POH Supplements must be in the airplane for flight operations when the subject equipment is installed or special operations are to be performed.

The Table of Contents shows all EXTRA Supplements available for the EXTRA 200. A check mark in the *Section* column indicates that the corresponding supplement must be included in this POH.

**Left blank intentionally**

**SECTION 901**

**STEERABLE TAIL WHEEL**

**Table of Contents**

<i>Paragraph</i>		<i>Page</i>
<b>901.1</b>	<b>GENERAL .....</b>	<b>901-3</b>
<b>901.2</b>	<b>LIMITATIONS .....</b>	<b>901-3</b>
<b>901.3</b>	<b>EMERGENCY PROCEDURES .....</b>	<b>901-3</b>
<b>901.4</b>	<b>NORMAL PROCEDURES .....</b>	<b>901-3</b>
<b>901.5</b>	<b>PERFORMANCE .....</b>	<b>901-3</b>
<b>901.6</b>	<b>WEIGHT AND BALANCE .....</b>	<b>901-3</b>
<b>901.7</b>	<b>DESCRIPTION OF THE SYSTEM .....</b>	<b>901-3</b>
<b>901.8</b>	<b>HANDLING, SERVICING AND MAINTENANCE .....</b>	<b>901-4</b>

**Left blank intentionally**

## **901 STEERABLE TAIL WHEEL**

### **901.1 GENERAL**

To improve taxi and handling quality, the EXTRA 200 can be equipped with an optional steerable tailwheel. The deflection angle of this tailwheel is arranged by the rudder control up to plus/minus 30°. Exceeding this deflection the tailwheel has a full-swivel capability by a release mechanism.

### **901.2 LIMITATIONS**

The operation limitations are not affected due to the use of the steerable tailwheel.

### **901.3 EMERGENCY PROCEDURES**

There is no change of basic emergency procedures with the installation of the steerable tailwheel.

### **901.4 NORMAL PROCEDURES**

They are no changes for the described normal procedures after installation of the steerable tailwheel. In addition to the existing normal procedures the light precompression of connector springs and movement of the rudder have to be checked during the preflight check.

### **901.5 PERFORMANCE**

Changes in flight performance due to installation of the steerable tailwheel are not noticeable. The given basic performance data under section 5 are still valid.

### **901.6 WEIGHT AND BALANCE**

A change of the running empty weight and resulting C.G. position after installation of the steerable tailwheel is neglectable, because of minor differences in weight and C/G between standard and optional steerable tailwheel.

### **901.7 DESCRIPTION OF THE SYSTEM**

The 5 inch tailwheel has a solid rubber tire and is rotatable by means of a wheelfork, which is connected to a bearing steelsleeve. This steelsleeve itself contains also the release mechanic, which gives the wheelfork a full-swivel capability exceeding plus/minus 30° deflection. The steelsleeve is glued into the glasfiberspring, which is bolted to the tail hardpoint of the aircraft. The steering of the tailwheel is accomplished by a direct mechanic link (rudder control cable) from the rudder pedals. The steering deflection of the tailwheel is controlled by the rudder movement and damped by anti shimmy connector springs.

### **901.8 HANDLING, SERVICING AND MAINTENANCE**

During 50 hour inspection, the bearing steelsleeve has to be lubricated on the point of lubricating. Additionally all parts of the tailwheel have to be inspected visually for deformations, cracks and corrosion.

**SECTION 903**

**ELECTRONIC ACCELEROMETER**

**Table of Contents**

<i>Paragraph</i>		<i>Page</i>
<b>903.1</b>	<b>GENERAL .....</b>	<b>903-3</b>
<b>903.2</b>	<b>LIMITATIONS .....</b>	<b>903-3</b>
<b>903.3</b>	<b>EMERGENCY PROCEDURES .....</b>	<b>903-3</b>
<b>903.4</b>	<b>NORMAL PROCEDURES .....</b>	<b>903-3</b>
<b>903.5</b>	<b>PERFORMANCE .....</b>	<b>903-3</b>
<b>903.6</b>	<b>WEIGHT AND BALANCE .....</b>	<b>903-3</b>
<b>903.7</b>	<b>DESCRIPTION AND OPERATION OF THE SYSTEM .....</b>	<b>903-3</b>
<b>903.8</b>	<b>HANDLING, SERVICING AND MAINTENANCE .....</b>	<b>903-9</b>

**Left blank intentionally**

---

---

**903 ELECTRONIC ACCELEROMETER**

**903.1 GENERAL**

The standard equipped accelerometer typ AN 5745 can be replaced by an optional "Digital Solid State Accelerometer DSA 12".

**903.2 LIMITATIONS**

The instrument markings and placards are provided for the acrobatic category (1 seat) only; for the acrobatic category (2 seat) and for the normal category refer to corresponding limitations.

Any exceedance of given limitations have to be reported by the pilot and considered by corresponding maintenance or inspection procedure according to the *SERVICE MANUAL EXTRA 200*.

Instrument markings

Electronic Accelerometer DSA 12

red range	-12 g	-	-10 g
yellow range	> -10 g	-	-8 g
green range	> -8 g	-	< +8 g
yellow range	+ 8 g	-	< +10 g
red range	+10 g	-	+12 g

**903.3 EMERGENCY PROCEDURES**

Not affected.

**903.4 NORMAL PROCEDURES**

Not affected.

**903.5 PERFORMANCE**

Not affected.

**903.6 WEIGHT AND BALANCE**

Not affected.

**903.7 DESCRIPTION AND OPERATION OF THE SYSTEM**

The DSA 12 accelerometer measures acceleration in one certain direction. The measuring range is between +20g and -20g. A clock inside the instrument measures time and date. One of the output-displays is an LCD with two lines and eight positions per line. Positive values of accelerations are always shown in the upper line of the LCD, and negative values of acceleration always in the bottom line.

The other output display are twentyfive LEDs which are arranged in a semicircle. The upper twelve LEDs show positive acceleration, the lower twelve LEDs show negative acceleration. The middle LED is on line all time long.

### INSTANTANEOUS ACCELERATION

The current value of acceleration is called **Instantaneous Acceleration**. It is shown by the LED-display if the value is between +12g and -12g. If the "Instantaneous Acceleration" is zero g, only the middle LED lights up. Every single g illuminates one more LED in positive (up) or negative (down) direction. For example:

The "Instantaneous Acceleration" is +5g, the middle LED and five LEDs in positive direction are illuminated. If the "Instantaneous Acceleration" is -7g, the middle LED and seven LEDs in negative direction are illuminated. In case the absolute value of the "Instantaneous Acceleration" is greater then 12g all twelve LEDs of this range are turned on.

### CURRENT EXTREME VALUES "A"

A permanent illumination of two LEDs, one for positive acceleration and another one for negative acceleration, shows the **Current Extreme Values**. They are signed by two illuminated LEDs, one in the positive and one in the negative range. These two "Current Extreme Values" are shown furthermore on the LC-Display in case of normal operation (the positive "Current Extreme Value" is shown in the upper line, and the negative "Current Extreme Value" is shown in the lower line).

They are both signed by an "A" as first character of every line. The "Current Extreme Values" change, if the "Instantaneous Acceleration" is greater than the last positive or lower than the last negative "Current Extreme Value" (the positive or the negative). The "Current Extreme Values" can be reset to 0g by pushing the buttons.

### TOTAL EXTREME VALUE "B"

Eventhough the two "Current Extreme Values" are reset to 0g, there will remain a positive and a negative **Total Extreme Value** in the memory. As soon as a "Current Extreme Value" occurs that is greater than the positive or lower than the negative "Total Extreme Value", the corresponding "Total Extreme Value" is exchanged with the "Current Extreme Value". This is a possibility to store the positive and the negative "Total Extreme Value" during different actions, while the "Current Extreme Values" are reset to 0g after every single action.

The "Total Extreme Values" can be shown or reset to 0g by pushing the buttons. They are signed with a "B" as the first character on every LC-Display line.

The "Total Extreme Values" only change if one of them is lower than the corresponding "Current Extreme Value" or if they are reset to 0g.

Here is an example: Since the last reset of the "Current Extreme Values" and the "Total Extreme Values" the maximum of the positive acceleration was +9g and the maximum of the negative acceleration was -5g. The "Instantaneous Acceleration" is +3g. Therefore the middle LED and the first three positive LEDs are illuminated for the "Instantaneous Acceleration". Furthermore the ninth LED in positive direction is illuminated for the positive "Current Extreme Value", and the fifth LED in negative direction for the negative "Current Extreme Value".

The LC-Display shows:

A	+ 9.0 g
A	- 5.0 g

After resetting the "Current Extreme Values", the LC-Display shows

A + 3.0 g  
A - 0.0 g

and only the middle LED and three LEDs in the positive range of the LED-Display are shining. If the display presents the "Total Extreme Value" you will see

A + 9.0 g  
A - 5.0 g

on the LC-Display, because the "Total Extreme Values" has not changed.

The "Total Extreme Values" only change if one of them is lower than the corresponding "Current Extreme Value" or if they are reset to 0g.

#### ABSOLUTE EXTREME VALUES "C"

Two further extreme acceleration values are the positive and the negative **Absolute Extreme Value**. These values are the greatest acceleration values that ever occurred. They can not be reset and they are stored in the long-term memory inside the instrument. Additionally, time and date these "Absolute Extreme Values" occurred are stored. These dates can be shown by the LC-Display by pushing the buttons.

The output of the "Absolute Extreme Values" is signed by a "C" as first character of the two LC-Display lines. The "Absolute Extreme Values" only change, if an "Instantaneous Value" occurs that is greater than the positive "Absolute Extreme Value" or lower than the negative "Absolute Extreme Value".

#### TIME AND DATE

You can recall the current **time** and **date** by pushing the buttons. If you want to change the current time and date of the clock, you have to enter the security code by the buttons. In case the code is wrong or you wait too long, the instrument will return into the "Normal Operating Mode". The clock module has its own battery power supply backup, preventing the clock from stopping even in case of turning off the master switch or disconnecting the DSA 12 from the electrical system of the aircraft.

**OPERATING INSTRUCTIONS**

The left button of the instrument will be called S1 and the right button will be called S2 during the following text. If the LC-Display shows acceleration values, then the upper line exhibits the positive acceleration, and the lower line shows the negative acceleration. If the LC-Display presents time and date, you will see the time in the upper line, and in the lower line you will see the date.

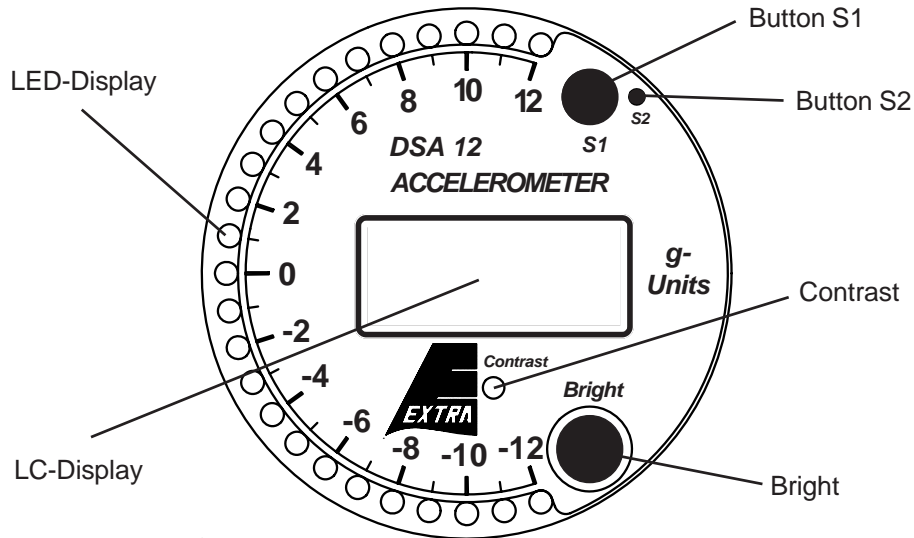

**1) THE FIRST SECONDS AFTER THE POWER ON**

All LEDs are lighted up during the first two seconds after the power on of the instrument. Both the "Current Extreme Value" and the "Total Extreme Value" are reset to 0g. The LCD shows:

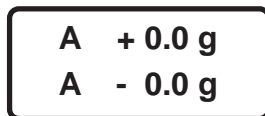

After two seconds the Instrument changes automatically into the "Normal Operating Mode".

**2) THE "NORMAL OPERATING MODE"**

In the "Normal Operating Mode" the instrument outputs the "Instantaneous Acceleration" and the "Current Extreme Values". The "Instantaneous Acceleration" is shown as a bar on the LED-Display. Furthermore one LED indicates the positive and another one indicates the negative "Current Extreme Value". The "Current Extreme Values" are also shown on the LC-Display and signed with an "A", for example:

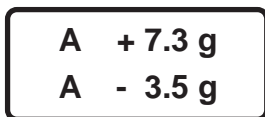

### 3) RESET OF THE "CURRENT EXTREME VALUES"

Push button: once S1

If you want to reset the "Current Extreme Value" to 0g (for example you want to measure the extreme values of the next flight figure), you have to push S1 once. In this case, all LEDs are lighting up for two seconds, the LC-Display is showing:

<b>A</b>	<b>+ 0.0 g</b>
<b>A</b>	<b>- 0.0 g</b>

and the "Current Extreme Value" is reset to 0g.  
On condition you push S1 for another time during this two seconds, you get to other submenus, else the instrument returns into the "Normal Operating Mode".  
All LEDs are illuminated during the submenus.

### 4) DISPLAY OF THE "TOTAL EXTREME VALUES"

Push button: twice S1

Reset of the "Total Extreme Values"

Push button: twice S1 and once S2 you push S1 twice, the LC-Display shows the "Total extreme values". These values are the maximums of positive and negative acceleration that occurred since the last reset of these values. They are signed with a "B" as first character of a line, like the following example:

<b>B</b>	<b>+ 8.4 g</b>
<b>B</b>	<b>- 4.2 g</b>

In case you want to reset these two values, you have to press S2 and the instrument sets the "Total extreme values" to 0g and returns into the "Normal Operating Mode". Provided you pushed S1 instead of S2, the LC-Display will show the "Absolute Extreme Values".  
If there is no button pushed, the instrument will return into the "Normal Operating Mode".

### 5) DISPLAY OF THE "ABSOLUTE EXTREME VALUES"

push button: three times S1  
Display of time and date of the "Absolute Extreme Values"

push button: three times S1 and once S2

After pushing S1 for three times, the LC-Display shows the greatest positive and the greatest negative acceleration the instrument ever measured. These two values are stored in the long-term memory of the instrument and signed with a "C" as first character of the LC-Display:

<b>C</b>	<b>+ 9.6 g</b>
<b>C</b>	<b>- 8.3 g</b>

Additionally the long-term memory stores the times and dates when new "Absolute Extreme Values" occur. They are shown if you push S2 next. In this case during the next twelve seconds the LC-Display shows under the title "MAX-DATE" the time and date of the positive "Absolute Extreme Value" and under the title "MIN-DATE" the time and date of the negative "Absolute Extreme Value". Afterwards the instrument returns into the "Normal Operating Mode".

If you push S1 instead of S2, the LC-Display will show the current time and date.

If there is no button pushed for about five seconds, the instrument will return into the "Normal Operating Mode".

## 6) OUTPUT OF TIME AND DATE

push button: four times S1

The LC-Display will exhibit time and date after you have pushed S1 for four times. For example:

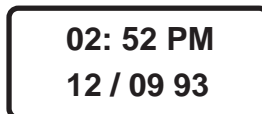

02: 52 PM  
12 / 09 93

is the ninth December 1993 at 2 o'clock and 52 minutes in the afternoon. If you want to set the clock, you have to push S1 for another time, otherwise the instrument returns into the "Normal Operating Mode".

## 7) SETTING OF THE CLOCK

push button: five times S1

You can only set the clock, if you know the right four digit code.

If you push S1 for five times, the LC-Display shows a request to enter the code. You can change the code-digit by pushing S2. To confirm your input of a digit you have to push S1. If the entered code-digits are wrong, or you wait longer than six seconds, the instrument will return into the "Normal Operating Mode".

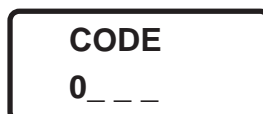

CODE  
0 \_ \_ \_

Provided it was the right code, the LC-Display shows the current time and Date with a cursor under the first digit. By pushing S2 you can change the digit. The change can be confirmed by pushing S1. In this case the cursor moves to the next digit. The instrument changes into the "Normal Operating Mode", if you have stepped through all digits with the cursor, or you waited more than six seconds without pushing a button. In this case the time and date on the display are transferred into the clock. If you try to enter an impossible number ( like 18 as months or 35 as days), the instrument turns

back into the "Normal Operating Mode" and the clock will be programmed with the correct changed numbers. The wrongly changed number is exchanged by its old value.

### **903.8 HANDLING, SERVICING AND MAINTENANCE**

If the absolute extreme value "C" indicates that the operating limits have been exceeded, the manufacturer must be informed. The battery inside, which is used for the clock power supply backup, is expected to have a lifetime of 5 to 10 years. A weak battery can be exchanged by the manufacturer only.

**Left blank intentionally**

---

---

**SECTION 904**

**EMERGENCY LOCATOR TRANSMITTER**

**Table of Contents**

<i>Paragraph</i>		<i>Page</i>
<b>904.1</b>	<b>GENERAL .....</b>	<b>904-3</b>
<b>904.2</b>	<b>LIMITATIONS .....</b>	<b>904-3</b>
<b>904.3</b>	<b>EMERGENCY PROCEDURES .....</b>	<b>904-4</b>
<b>904.4</b>	<b>NORMAL PROCEDURES .....</b>	<b>904-6</b>
<b>904.5</b>	<b>PERFORMANCE .....</b>	<b>904-6</b>
<b>904.6</b>	<b>WEIGHT AND BALANCE .....</b>	<b>904-6</b>
<b>904.7</b>	<b>DESCRIPTION OF THE SYSTEM .....</b>	<b>904-6</b>
<b>904.8</b>	<b>HANDLING, SERVICING AND MAINTENANCE .....</b>	<b>904-7</b>

**Left blank intentionally**

## 904 EMERGENCY LOCATOR TRANSMITTER

### 904.1 GENERAL

To improve the passive security, the EXTRA 200 can be equipped with an optional Emergency Locator Transmitter POINTER 3000 ELT. This POINTER 3000 ELT transmits automatically after a crash or manual activity on the emergency frequencies of 121.5 MHz (civilian) and 243.0 MHz (military).

### 904.2 LIMITATIONS

The operation limitations are not effected due to the installation of the POINTER 3000 ELT. For the location and operation of the transmitter the following placards have to be attached in the aircraft:

**ELT located here** - placard outside on the left fuselage board in high of the ELT-unit,

**ELT** - placard over the ELT- circuit breaker (see Fig.1) ,

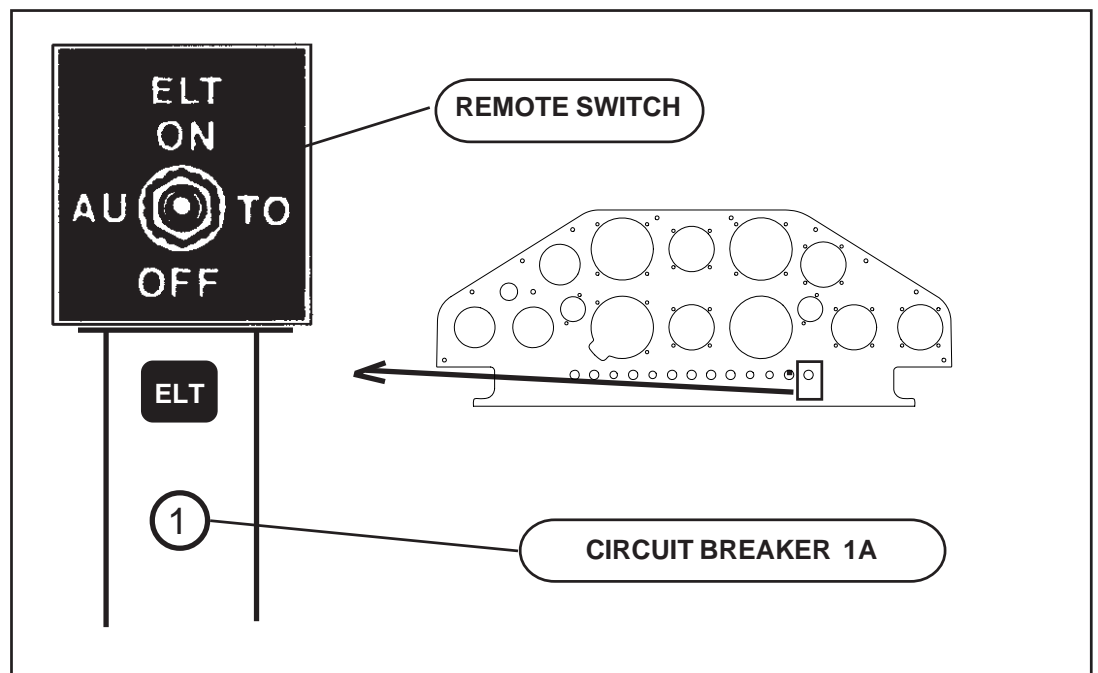
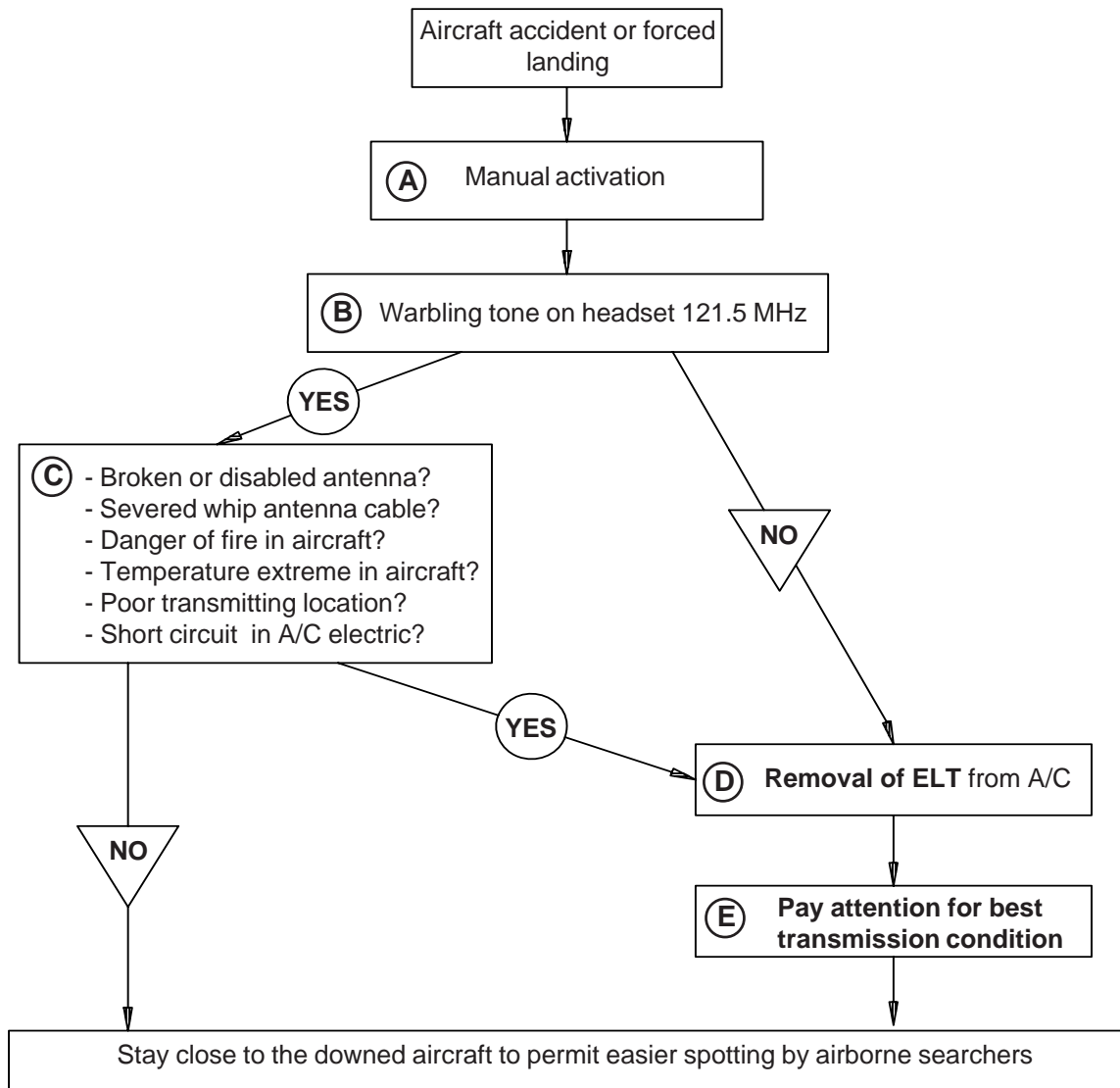

Figure 1

904.3 EMERGENCY PROCEDURES



**A ) Automatic and manual activation**

Although the ELT will be activated automatically by a *ROLAMITE* Type INTERTIA switch after an aircraft accident or forced landing with high G-force, turn additionally the remote switch (optional) in the rear panel or the unit master switch at the ELT unit to "ON" position. The ELT will send a signal on the emergency frequencies of 121.5 MHz and 243.0 MHz.

**B ) Control of the ELT**

If the aircraft receiver is operable listen on 121.5 MHz for ELT transmission. Ensure that whip antenna is clear of obstruction.

### C ) Operating of the ELT in the portable mode

After forced landing or aircraft accident it may be desirable to use the transmitter in the portable mode. Various reasons may necessitate this, such as:

- |  |   |                       |
|--|---|-----------------------|
| - Broken or disabled whip antenna:         | ⇒ | Ⓓ REMOVE ELT FROM A/C |
| - Severed whip antenna cable:              |   | "                     |
| - Danger of fire or explosion in aircraft: |   | "                     |
| - Temperature extremes in aircraft:        |   | "                     |
| - Poor transmitting location:              |   | "                     |

### D ) Removal of ELT from aircraft:

**NOTE**

Accomplish as quickly as possible to resume or start emergency signal.

1. Turn the unit master switch to "**OFF**"-position.
2. Disconnect whip antenna cable and remote switch cable.
3. Turn winged nut on rear bracket clip to release transmitter (remove ELT).
4. Remove the telescope antenna from the stowage clips and insert into the ANT receptacle. Extend antenna fully.

**CAUTION**

5. Turn unit master switch to "**ON**" position. Do not use the "AUTO"position!

### E ) Best transmission may be obtained by:

- Keeping antenna vertical.
- Standing transmitter upright on a metallic surface, such as an aircraft wing or stabilizer.
- If terrain prohibits good transmission (such as a deep valley or canyon) place the transmitter on the high ground or hold in hand on high place.
- Stay close to the downed aircraft.
- In freezing weather, place transmitter inside jacket or coat to keep the battery warm. Let the antenna extend outside jacket.
- Keep all moisture and ice away from the antenna connection and the remote connector pins.

**CAUTION**

Do not turn POINTER portable "**OFF**" - even by night as search aircraft may be enroute around the clock. Even when you have been sighted or think you have, the spotting aircraft may not be able to relay an accurate or timely "fix" on your position without a continued signal.

Only when the rescue team appears discontinue signalling by using the "OFF" position.

**904.4 NORMAL PROCEDURES**

There is no change of basic normal procedures with the installation of the POINTER 3000 ELT. In addition to the existing normal procedures the "AUTO" position of the unit master switch or the remote switch has to be checked during the preflight check.

**904.5 PERFORMANCE**

Not affected.

**904.6 WEIGHT AND BALANCE**

Not affected.

**904.7 DESCRIPTION OF THE SYSTEM**

The used Emergency Locator Transmitter is a POINTER 3000 ELT from the POINTER INC., Tempe, Arizona. After an activation the necessity signal is transmitted on the 121,5 MHz and the 243.0 MHz for a period of 48 hours at -20° respectively 2 hours at +50°. The Inertia-switch releases the necessity signal after a G-force of  $5 \pm 2/0$  g in aircraft-longitudinal axis and a duration of  $11 \pm 5/0$  milliseconds. When properly installed, parallel to the line of flight, the ELT will not activate due to turbulence, normal operation, or aerobatics.

**POINTER PORTABLE ELT MAYOR SYSTEM COMPONENTS**

The POINTER PORTABLE ELT System consists of the following components:

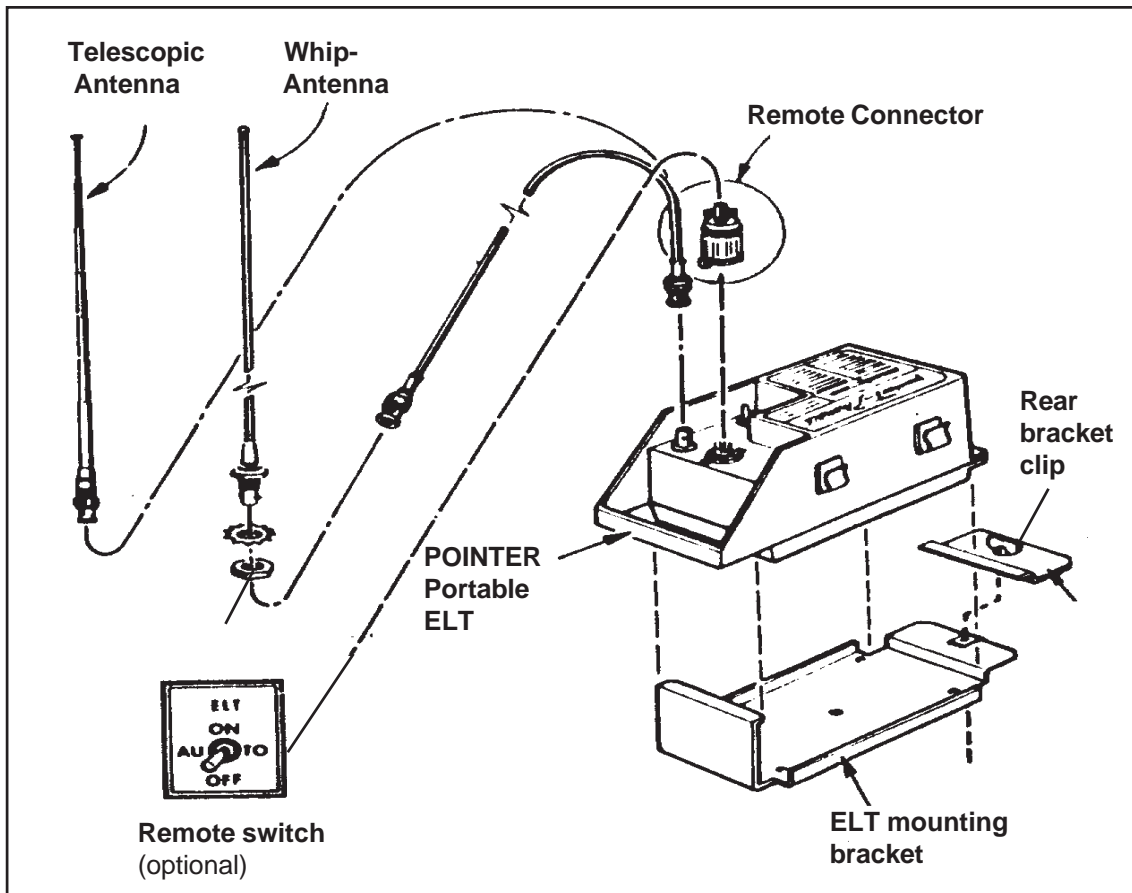

## OPERATING INSTRUCTION OF THE TRANSMITTER

The operation of the ELT is possible over the master unit switch or over the remote switch (optional) in the panel.

### UNIT MASTER SWITCH

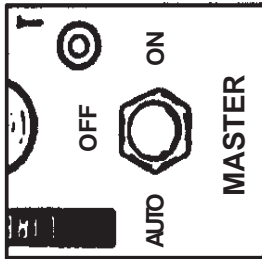

**ON:** used to activate the transmitter for test or emergency situations

**OFF:** used to de-activate transmitter or to insure non-activation by handling

**AUTO:** used to arm the Pointer Portable for automatic activation by the "G" switch only.

### REMOTE SWITCH (optional)

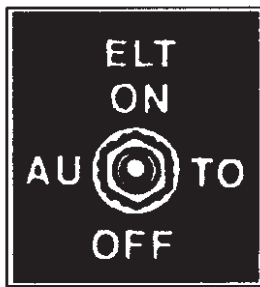

**ON:** used to remotely activate the transmitter for test or emergency situation. An example of such an emergency situation would be forced landing with an impact insufficient to activate the Rolamite "G"-switch.

**AUTO:** used to arm the Pointer Portable for automatic activation by the "G" switch only.

**OFF:** used to de-activate transmitter after automatic activation by the "G"-switch

## 904.8 HANDLING, SERVICING AND MAINTENANCE

Visually inspect the unit at regular intervals for cleanliness and secureness.

Check whip antenna mounting and cable connections for tightness.

In accordance with FAA regulations, batteries must be replaced after 2 years shelf or service life or for any of the following reasons:

- after the transmitter has been used in emergency situation (including any inadvertent activation of unknown duration),
- after the transmitter has been operated for more than one cumulative hour,
- on or before battery replacement date.

**Left blank intentionally**

**SECTION 905**

**EXTERNAL POWER**

**Table of Contents**

<i>Paragraph</i>		<i>Page</i>
<b>905.1</b>	<b>GENERAL .....</b>	<b>905-3</b>
<b>905.2</b>	<b>LIMITATIONS .....</b>	<b>905-3</b>
<b>905.3</b>	<b>EMERGENCY PROCEDURES .....</b>	<b>905-3</b>
<b>905.4</b>	<b>NORMAL PROCEDURES .....</b>	<b>905-3</b>
<b>905.5</b>	<b>PERFORMANCE .....</b>	<b>905-4</b>
<b>905.6</b>	<b>WEIGHT AND BALANCE .....</b>	<b>905-4</b>
<b>905.7</b>	<b>DESCRIPTION OF THE SYSTEM .....</b>	<b>905-4</b>
<b>905.8</b>	<b>HANDLING, SERVICING AND MAINTENANCE .....</b>	<b>905-5</b>

**Left blank intentionally**

## 905 External Power

### 905.1 GENERAL

The EXTRA 200 can be equipped with two versions of an optional external power receptacle system. The "normal" system (PN 93102.16-01) provides the capability to start the engine independent of the board battery and is limited to this use. The "continuous operation" system (PN 93102.16-02) further allows feeding the electrical system for longer periods.

### 905.2 LIMITATIONS

The operation limitations are not affected due to the installation of the external power receptacle system. For the location of the external power receptacle and protection of the electrical connection cable against overheating the following placard has to be attached on the rear instrument panel with an indicator arrow to the receptacle:

**EXTERNAL POWER 12V**  
**DO NOT CRANK FOR MORE THAN 10 SECONDS!**  
Allow 20 seconds to cool-down between attempts. Repeat up to 6 times.  
Then let starter cool for 30 minutes.

### 905.3 EMERGENCY PROCEDURES

Not affected.

### 905.4 NORMAL PROCEDURES

The following starting procedures are recommended, however, the starting conditions may necessitate some variation from these procedures.

1. Perform Pre-flight inspection.
2. Set propeller governor control to "High RPM" position.
3. Open throttle approximately 1/4 travel.
4. **Master switch "OFF"**
5. Put the external power plug into the board receptacle
6. Turn boost pump "ON".
7. Move mixture control to "FULL RICH" until a slight but steady fuel flow is noted (approximately 3 to 5 seconds) and return mixture control to "IDLE CUT-OFF".  
Turn boost pump "OFF".

**CAUTION**

**Pay attention to objects and persons in the propeller operating area!  
Hold the canopy tight!**

8. Apply the brakes.
9. Engage starter.
10. When engine fires release the ignition switch back to "BOTH".
11. Pull the external power plug from the board receptacle.
12. Move mixture control slowly and smoothly to "FULL RICH".

13. Check the oil pressure gauge. If minimum oil pressure is not indicated within 30 seconds, shut off the engine and determine trouble.

**14. Master switch "ON".**

**905.5 PERFORMANCE**

Not affected.

**905.6 WEIGHT AND BALANCE**

Not affected.

**905.7 DESCRIPTION OF THE SYSTEM**

The external power receptacle is attached left under the rear seat. The main-relais is located at the left side of the firewall, above the starter-relais. For the avoidance of sparks, this relais does not switch before a safe contact from plug to receptacle is ensured. During the engine start, the master switch has to be switch in "OFF"-position for the disconnection of the battery from the aircraft electric circuit.

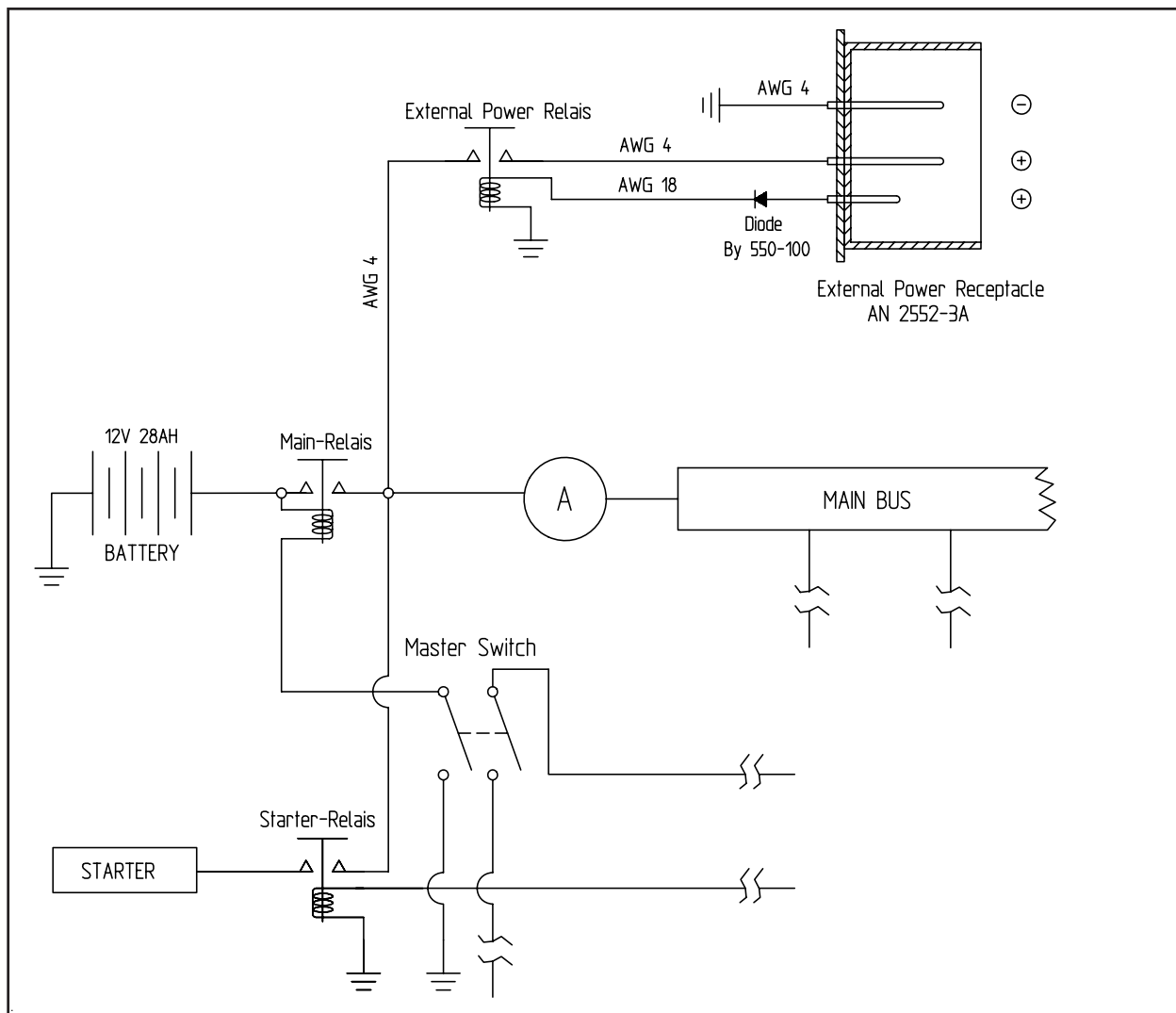

**905.8 HANDLING, SERVICING AND MAINTENANCE**

Not affected.

**Left blank intentionally**

---

---

**SECTION 907**

**LONG RANGE WING TANK CAPACITY**

**Table of Contents**

<i>Paragraph</i>		<i>Page</i>
<b>907.1</b>	<b>GENERAL .....</b>	<b>907-3</b>
<b>907.2</b>	<b>LIMITATIONS .....</b>	<b>907-3</b>
<b>907.3</b>	<b>EMERGENCY PROCEDURES .....</b>	<b>907-3</b>
<b>907.4</b>	<b>NORMAL PROCEDURES .....</b>	<b>907-3</b>
<b>907.5</b>	<b>PERFORMANCE .....</b>	<b>907-4</b>
<b>907.6</b>	<b>WEIGHT AND BALANCE .....</b>	<b>907-5</b>
<b>907.7</b>	<b>DESCRIPTION OF THE SYSTEM .....</b>	<b>907-5</b>
<b>907.8</b>	<b>HANDLING, SERVICING AND MAINTENANCE .....</b>	<b>907-6</b>

**Left blank intentionally**

**907 LONG RANGE WING TANK CAPACITY**

**907.1 GENERAL**

The leading edge wing tank on the EXTRA 200 equipped with the long range tank capacity features two tank compartments on either wing side. The compartments are separated by a slosh rib.

**907.2 LIMITATIONS**

**FUEL**

Minimum grade aviation gasoline: 100/100LL;  
for alternate fuelgrades see latest revision of Lyc. S.I. No. 1070

Total fuel capacity	<b>190 L</b>	<b>(50.2 US Gallons).</b>
- Wingtanks:	<b>154 L (2 x 77 L)</b>	<b>(40.7 US Gallons)</b>
- Acro & Center Tank:	<b>36 L</b>	<b>( 9.5 US Gallons)</b>

Usable fuel capacity in the system: **185 L (48.0 US Gallons).**

For acrobatic flight wing tanks must be empty.

Usable fuel capacity for acrobatic: **32 L (8.5 US Gallons).**

**WEIGHT LIMITS**

Max. allowed **empty** weight - Normal category: 621 kg (1368lbs)

**PLACARD**

The existing "FUEL SELECTOR VALVE"- placard has to be replaced by the following placard:

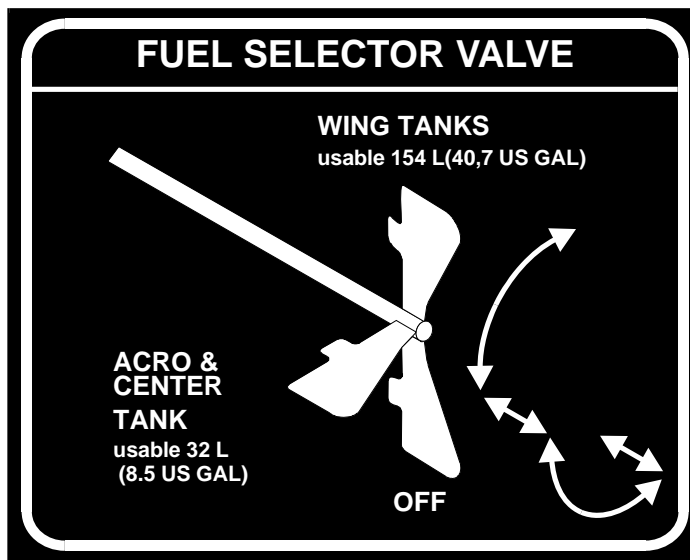

(in both cockpits  
near selector valve handle)

**907.3 EMERGENCY PROCEDURES**

Not affected.

**907.4 NORMAL PROCEDURES**

Not affected.

**907.5 PERFORMANCE**

**RANGE AND ENDURANCE**

Range and endurance values for a T/O Weight of 840 kg (1852 lbs) including fuel for warm up and take-off from sea level, max. continuous power climb to cruising altitude, and a reserve of 19 litre (5 US Gal.) for 45 minutes with 45% power. 5 litres (1,3 US Gal.) unusable fuel is taken into account. (At ISA-Conditions).

PA [ft]	Eng. [RPM]	Manif. Press. [IN HG]	Power Setting		Fuel Consumption		TAS		IAS		Endur. ① [h]	Range ① [NM]	Mixture ② Best ...
			[%]	[Hp]	[l/h]	(gal/h)	[Kts]	(km/h)	[Kts]	(km/h)			
2000	2400	25,0	75	150	46	(12,2)	141	(261)	135	(250)	3,15	494	Power
	2300	23,5	65	130	34	(9,0)	134	(248)	128	(237)	4,73	633	Economy
	2000	23,5	55	110	29	(7,7)	126	(233)	122	(226)	5,54	698	Economy
4000	2400	24,5	75	150	46	(12,2)	145	(269)	135	(250)	3,52	508	Power
	2200	23,8	65	130	34	(9,0)	138	(256)	128	(237)	4,73	651	Economy
	2000	23,1	55	110	29	(7,7)	130	(241)	123	(228)	5,52	717	Economy
6000	2500	23,1	75	150	46	(12,2)	150	(278)	135	(250)	3,53	524	Economy
	2200	23,0	65	130	34	(9,0)	142	(263)	128	(237)	4,71	665	Economy
	2000	22,8	55	110	29	(7,7)	134	(248)	123	(228)	5,49	734	Economy
8000	2350	21,5	65	130	34	(9,0)	146	(270)	128	(237)	4,69	679	Economy
	2050	21,5	55	110	29	(7,7)	138	(256)	122	(226)	5,46	750	Economy
10000	2500	19,9	65	130	35	(9,2)	150	(278)	128	(237)	4,54	671	Economy
	2200	20,0	55	110	30	(7,9)	142	(263)	121	(224)	5,25	738	Economy
12000	2300	18,3	55	110	31	(8,2)	146	(270)	122	(226)	5,1	727	Economy

**NOTE**

- ① For temperatures above/ below Standard (ISA), increase/decrease range 1,7% and endurance 1,1% for each 10°C above/below Standard Day Temperature for particular altitude.
- ② **Leaning with exhaust gas temperature (EGT) gage**  
For the adjustment "**Best Power**", first lean the mixture to achieve the top exhaust temperature (peak EGT) and then enrich again until the exhaust temperature is 100°F lower than peak EGT.

For the adjustment "**Best Economy**", simply lean the mixture to achieve the top exhaust temperature (peak EGT).

**Leaning without exhaust gas temperature (EGT) gage and flowmeter**

Slowly move mixture control from "Full rich" position towards lean position. Continue leaning until slight loss of power is noted (Loss of power may or may not be accompanied by rough engine run). Then enrich until engine runs smoothly and power is regained.

**CAUTION**

Always return the mixture to full rich before increasing power settings.

**907.6 WEIGHT AND BALANCE**

**LOADING WEIGHTS AND MOMENTS**

TOTAL FUEL CAPACITY: 190 LITER (52,2 US GAL.)

FUEL					
ACRO & CENTER TANK			WING TANK		
LITER (US GAL)	KG (LBS)	KG x CM (LBS x IN)	LITER (US GAL)	KG (LBS)	KG x CM (IN x LBS)
5 (1,3)	3,6 (8)	126 (109)	10 (2,6)	7,2 (16)	361 (312)
10 (2,6)	7,2 (16)	252 (218)	20 (5,3)	14,4 (32)	721 (625)
15 (4,0)	10,8 (24)	378 (327)	30 (7,9)	21,6 (48)	1082 (937)
20 (5,3)	14,4 (32)	504 (437)	40 (10,6)	28,8 (63)	1443 (1250)
25 (6,6)	18,0 (40)	630 (546)	50 (13,2)	36,0 (79)	1804 (1562)
30 (7,9)	21,6 (48)	756 (655)	60 (15,8)	43,2 (95)	2164 (1875)
36 (9,5)	25,9 (58)	932 (799)	70 (18,5)	50,4 (111)	2525 (2187)
			80 (21,1)	57,6 (127)	2886 (2499)
			90 (23,7)	64,8 (143)	3246 (2812)
			100 (26,4)	72,0 (158)	3607 (3124)
			110 (29,0)	79,2 (174)	3968 (3437)
			120 (31,7)	86,4 (190)	4329 (3749)
			130 (34,3)	93,6 (206)	4689 (4062)
			140 (36,9)	100,8 (222)	5050 (4374)
			150 (39,6)	108,0 (238)	5411 (4687)
			154 (40,6)	110,9 (244)	5555 (4811)

**907.7 DESCRIPTION OF THE SYSTEM**

Wing tank:

The leading edge section of each wing in front of main spars forms an integral fuel tank providing two interconnected tanks with 154 litres (40,7 US GAL.) total capacity. Each side of the wing has a 2" diameter filler cap for gravity refuelling. The long range tank has two compartments in either wing which are separated by a slosh rib. Due to the interconnection the fuel level of the left and right integral tank will equalize during refuelling within reasonable time. For max. fuel capacity, the first filled side have to be filled once again! Furthermore the wing tank is connected directly to the engine by the fuel selector valve. Unusable fuel is approximately 1 liter (0.3 US Gal.).

**907.8 HANDLING, SERVICING AND MAINTENANCE**

Not affected.

**SECTION 908**

**AIRTOW HOOK**

**Table of Contents**

<i>Paragraph</i>		<i>Page</i>
<b>908.1</b>	<b>GENERAL .....</b>	<b>908-3</b>
<b>908.2</b>	<b>LIMITATIONS .....</b>	<b>908-3</b>
<b>908.3</b>	<b>EMERGENCY PROCEDURES .....</b>	<b>908-4</b>
<b>908.4</b>	<b>NORMAL PROCEDURES .....</b>	<b>908-4</b>
<b>908.5</b>	<b>PERFORMANCE .....</b>	<b>908-5</b>
<b>908.6</b>	<b>WEIGHT AND BALANCE .....</b>	<b>908-7</b>
<b>908.7</b>	<b>DESCRIPTION OF THE SYSTEM .....</b>	<b>908-7</b>
<b>908.8</b>	<b>HANDLING, SERVICING AND MAINTENANCE .....</b>	<b>908-7</b>

**Left blank intentionally**

**908 AIRTOW HOOK**

**908.1 GENERAL**

The EXTRA 200 can optionally be equipped with a "TOST" glider air-tow release Typ E 85. The release mechanism is mounted at the tail spring end and actuated from the cockpit by a yellow knob.

The following combinations are certified:

**Aircraft**

Engine: AEIO 360-A1E  
Propeller: MTV-12-B-C/C183-17e  
Exhaust system: Typ Gomolzig EA 200-606000

Air-tow release system according to replacement instruction: UA-300-4-95  
Air-tow release: "TOST, E 85"

**Glider**

MTOW of the glider: 765Kg  
Max. air towing speed of the glider: min. 140 Km/h

**Air tow cable and breaking piece (weak links)**

Length of the synthetic tow between 40 m and 60 m  
Ultimate load of the air-tow max. 850 kp (1875 lbs)  
If tows with higher ultimate load are used a breaking piece (weak links) of max. 850 kp (1875 lbs) needs to be interconnected.

**908.2 LIMITATIONS**

For a safe air towing the following points must be observed:

	1 seat	2-seats *
Max. Takeoff Weight	700 kg (1548 lbs)	800 kg (1769 lbs)
Max. Empty Weight	591 kg (1307 lbs)	606 kg (1340 lbs)
Min. Air-Towing Speed	63 KIAS (117 km/h)	67 KIAS (124 km/h)
Best Air-Towing Speed	71-75 KIAS (131-139 km/h)	73-77 KIAS (135-143 km/h)

**NOTE \***

2-seats only in case of an instruction flight!

- 1.) Maximum air-towing speed = maximum permissible air-towing speed of the glider.
- 2.) The maximum permissible cylinder head temperature is 500° F (red line).
- 3.) Interior mirror mounted.

For the location of the yellow release knob the following placard has to be attached in the near of the knob:

**AIR TOW**

**908.3 EMERGENCY PROCEDURES**

**A) START STOP DURING TAKE-OFF**

- |                        |                      |
|------------------------|----------------------|
| 1. Pilot of the glider | INFORM               |
| 2. Throttle            | IDLE                 |
| 3. Mixture             | IDLE CUT OF          |
| 4. Aircraft            | ROLLOUT AND BREAKING |

**B) ENGINE FAILURE IMMEDIATELY AFTER TAKE-OFF**

Stall speed: 59 KIAS

- |                        |                        |
|------------------------|------------------------|
| 1. Pilot of the glider | INFORM                 |
| 2. Air tow             | RELEASE                |
| 3. Airspeed            | 80 KIAS (148 km/h)     |
| 4. Mixture             | IDLE CUT OFF           |
| 5. Fuel shutoff valve  | OFF (Pull & Turn)      |
| 6. Ignition switch     | OFF                    |
| 7. Master switch       | OFF                    |
| 8. Forced landing      | PERFORM AS PRACTICABLE |

**C) EXCESSIVE "CLIMB OVER" OF THE AIRCRAFT BY THE TOWING GLIDER**

- |                        |                        |
|------------------------|------------------------|
| 1. Pilot of the glider | INFORM                 |
| 2. Air tow             | RELEASE                |
| 3. Landing             | PERFORM AS PRACTICABLE |

**D) TOW BREAK**

- |                        |                        |
|------------------------|------------------------|
| 1. Pilot of the glider | INFORM                 |
| 2. Landing             | PERFORM AS PRACTICABLE |

**908.4 NORMAL PROCEDURES**

Preflight inspection, starting procedures, take-off procedure and the following climbing flight have to be carry out in accordance with Chapter 4 "Normal Procedures". In addition to this procedures the following points have to be observed:

**A) PRIOR TO THE TAKE OFF**

A release test needs to be conducted to determine safe release operation. The test shall be made on both, aircraft and glider.

**B) TAKE OFF**

After air-tow hook up the tow shall be tighened gently. During the following take-off and climb the maximum air-tow speed of the glider must be observed.

**C) CLIMB**

While climbing the max C.H.T. must be observed. Towing light gliders, the intial climb angle may be very steep. Information of the glider pilot is recomended.

**D) RELEASE**

After the release of the glider a gently left handed descent shall be flow to avoid collision of glider and air-tow.

**E) DESCENT AND LANDING**

While descending the engine temperatures shall be observed (Danger of overcooling). Final approach should account for the air-tow hanging below the aircraft flight path.

**908.5 PERFORMANCE**

The existing POH-Data remain valid with the exception of:

**TAKE-OFF DISTANCE** (in Meter)

Conditions:

Power: over 2600 Rpm and full throttle, mixture rich,  
short grass, dry and paved level runway, no wind,  
Max. takeoff weight of the towing aircraft: 700Kg (1543lbs)

Liftoff speed (T/O): 65 KIAS = 120 Km/h indicated

Obstacle clearance speed over 15m (50ft) : 70 KIAS = 130 Km/h indicated

For every 5 kts (9 km/h) headwind, the takeoff (T/O) distance can be decreased by 5%.

For every 2 kts (4 km/h) tailwind [up to 10 kts (19 km/h)], the (T/O) distance is increased by 10%.

**CAUTION**

All values are valid for **single-pilot** air-towing operation (700kg MTOW). In case of an instruction flight with copilot, the higher takeoff weight has to be considered!  
The maximum permissible air-towing speed of the glider needs to be observed!

**Takeoff weight glider: 350 Kg**

Press.- altitude	-10°C OAT		0°C		10°C		20°C		30°C		40°C	
	T/O	50 ft	T/O	50 ft	T/O	50 ft	T/O	50 ft	T/O	50 ft	T/O	50 ft
0 ft	201	311	223	346	248	385	274	425	302	469	332	515
2000 ft	234	362	260	404	289	448	320	496	353	547	388	601
4000 ft	273	423	304	472	338	524	374	580	413	640	454	704
6000 ft	320	496	357	553	396	615	439	681	484	751	533	827
8000 ft	376	583	419	651	466	723	571	801	570	885	628	974

**Takeoff weight glider: 600 Kg**

Press.- altitude	-10°C OAT		0°C		10°C		20°C		30°C		40°C	
	T/O	50 ft	T/O	50 ft	T/O	50 ft	T/O	50 ft	T/O	50 ft	T/O	50 ft
0 ft	270	419	301	467	334	518	370	574	408	632	448	695
2000 ft	315	488	351	544	390	604	431	669	476	738	523	811
4000 ft	368	571	410	636	456	707	504	782	557	863	612	949
6000 ft	431	669	481	746	534	829	592	918	653	1013	719	1115
8000 ft	507	786	566	877	629	975	697	1080	769	1193	847	1314

**Takeoff weight glider: 765 Kg**

Press.- altitude	-10°C OAT		0°C		10°C		20°C		30°C		40°C	
	T/O	50 ft	T/O	50 ft	T/O	50 ft	T/O	50 ft	T/O	50 ft	T/O	50 ft
0 ft	346	536	385	597	428	663	473	734	522	809	573	889
2000 ft	403	625	449	696	499	773	552	856	608	944	669	1038
4000 ft	471	730	525	814	583	904	645	1001	712	1104	783	1214
6000 ft	552	856	615	954	684	1060	757	1174	836	1296	920	1426
8000 ft	648	1006	724	1122	804	1247	891	1382	984	1526	1083	1680

**CLIMBRATE**

Conditions:

Power: 2500 Rpm and full throttle, mixture rich,

Speed of the aircraft tow: 76 KIAS = 140 Km/h,

Weight of the towing aircraft: m = 700 Kg (1543lb), (1 Pilot = 86 Kg, Arco & Center Tank full 36 L, Wingtank 20 L)

**Tow force: glider with m = 350 Kg**

Pressure altitude	0°C OAT		10°C		20°C		30°C	
	ft/min	m/s	ft/min	m/s	ft/min	m/s	ft/min	m/s
0 ft	1210	6,1	1130	5,7	1050	5,3	970	4,9
1000 ft	1130	5,7	1050	5,3	970	4,9	890	4,5
2000 ft	1050	5,3	970	4,9	890	4,5	810	4,1
3000 ft	970	4,9	890	4,5	810	4,1	730	3,7
4000 ft	890	4,5	810	4,1	730	3,7	650	3,3
5000 ft	810	4,1	730	3,7	650	3,3	570	2,9
6000 ft	730	3,7	650	3,3	570	2,9	500	2,5
7000 ft	650	3,3	570	2,9	500	2,5	430	2,2
8000 ft	570	2,9	500	2,5	430	2,2	360	1,8

**Tow force: glider with m = 600 Kg**

Pressure altitude	0°C OAT		10°C		20°C		30°C	
	ft/min	m/s	ft/min	m/s	ft/min	m/s	ft/min	m/s
0 ft	1060	5,4	980	5,0	900	4,6	820	4,2
1000 ft	970	4,9	890	4,5	810	4,1	730	3,7
2000 ft	900	4,6	810	4,1	730	3,7	650	3,3
3000 ft	810	4,1	720	3,7	650	3,3	570	2,9
4000 ft	700	3,6	640	3,2	570	2,9	490	2,5
5000 ft	640	3,2	560	2,8	490	2,5	400	2,0
6000 ft	560	2,8	480	2,4	400	2,0	320	1,6
7000 ft	480	2,4	400	2,0	320	1,6	240	1,2
8000 ft	390	2,0	310	1,6	240	1,2	160	0,8

**Tow force: glider with m = 765 Kg**

Pressure altitude	0°C OAT		10°C		20°C		30°C	
	ft/min	m/s	ft/min	m/s	ft/min	m/s	ft/min	m/s
0 ft	810	4,1	725	3,7	650	3,3	570	2,9
1000 ft	720	3,7	640	3,2	565	2,9	495	2,5
2000 ft	640	3,2	570	2,9	490	2,5	415	2,1
3000 ft	560	2,8	480	2,4	410	2,1	340	1,7
4000 ft	400	2,4	400	2,0	330	1,7	260	1,3
5000 ft	400	2,0	320	1,6	250	1,3	175	0,9
6000 ft	320	1,6	240	1,2	165	0,8	90	0,5
7000 ft	240	1,2	160	0,8	90	0,5	0	0,0
8000 ft	160	0,8	80	0,4	0	0,0	0	0,0

#### **908.6 WEIGHT AND BALANCE**

Not affected.

#### **908.7 DESCRIPTION OF THE SYSTEM**

The release mechanism is a typ "E 85" of the "TOST" company, Munich. It is mounted at the tail spring rear end aft the tail wheel and activated with a yellow handle located at the rear seat cockpit via a bowden cable.

#### **908.8 HANDLING, SERVICING AND MAINTENANCE**

Service and maintenance needs to be conducted in accordance with the latest operation handbook (Typ E 85) of the manufacturer TOST GmbH, Germany. Additionally during the 100 h inspection the bowden cable and the release handle have to be checked.

**Left blank intentionally**

**SECTION 911**

**SINGLE SEAT CANOPY**

**Table of Contents**

<i>Paragraph</i>		<i>Page</i>
<b>911.1</b>	<b>GENERAL .....</b>	<b>911-3</b>
<b>911.2</b>	<b>LIMITATIONS .....</b>	<b>911-3</b>
<b>911.3</b>	<b>EMERGENCY PROCEDURES .....</b>	<b>911-3</b>
<b>911.4</b>	<b>NORMAL PROCEDURES .....</b>	<b>911-3</b>
<b>911.5</b>	<b>PERFORMANCE .....</b>	<b>911-3</b>
<b>911.6</b>	<b>WEIGHT AND BALANCE AND EQUIPMENT LIST .....</b>	<b>911-3</b>
<b>911.7</b>	<b>DESCRIPTION OF THE SYSTEM .....</b>	<b>911-3</b>
<b>911.8</b>	<b>HANDLING, SERVICE AND MAINTENANCE .....</b>	<b>911-3</b>

**Left blank intentionally**

## **911 SINGLE SEAT CANOPY**

### **911.1 GENERAL**

To change the appearance of the EA-200 the standard canopy can be replaced by a single seat canopy.

### **911.2 LIMITATIONS**

With the single seat canopy installed the aircraft is limited to the categories NORMAL and ACRO I.

In the NORMAL category the aircraft can be flown only with the pilot in the rear seat.

### **911.3 EMERGENCY PROCEDURES**

Not affected.

### **911.4 NORMAL PROCEDURES**

Before starting engine, check front seat area and ensure seat belts and shoulder harness of front seat are completely removed or fastened and secured, so that nothing can obstruct the free movement of controls.

### **911.5 PERFORMANCE**

Not affected.

### **911.6 WEIGHT AND BALANCE AND EQUIPMENT LIST**

Refer to the equipment list in section 6.

### **911.7 DESCRIPTION OF THE SYSTEM**

The single seat canopy has been designed to easily replace the standard canopy. This can be achieved by using the same canopy frame, hinges and latches included. The front seat is covered by the flat portion of the frame in front of the canopy. Operation of the locking mechanism is feasible only from the rear seat.

### **911.8 HANDLING, SERVICE AND MAINTENANCE**

Not affected.

**Left blank intentionally**

---

---

**SECTION 912**

**FILSER TRT 600 TRANSPONDER**

**Table of Contents**

<i>Paragraph</i>		<i>Page</i>
<b>912.1</b>	<b>GENERAL .....</b>	<b>912-3</b>
912.1.1	Front Panel Operation .....	912-3
912.1.2	System Operation .....	912-5
912.1.3	Error Reporting / Fault Codes .....	912-7
<b>912.2</b>	<b>LIMITATIONS .....</b>	<b>912-8</b>
<b>912.3</b>	<b>EMERGENCY PROCEDURES .....</b>	<b>912-8</b>
<b>912.4</b>	<b>NORMAL PROCEDURES .....</b>	<b>912-8</b>
<b>912.5</b>	<b>PERFORMANCE .....</b>	<b>912-8</b>

**Left blank intentionally**

912.1 GENERAL

The TRT 600 is Level 2es Class2 (SSR Mode S Elementary Surveillance) Transponder. It has Mode A, Mode A/C and Mode S capability. In Mode S the transponder provides acquisition capability. Furthermore, the TRT 600 has a built-in barometric pressure altitude coder in 100 ft increments.

**NOTE**

Refer to latest edition of Filser TRT 600 Pilot's Operation Manual (Doc. No. 03.200.010.11) to get familiar with the TRT 600 Transponder.

The following illustration of the front panel of the TRT 600 will assist the operator to understand this Mode S Transponder.

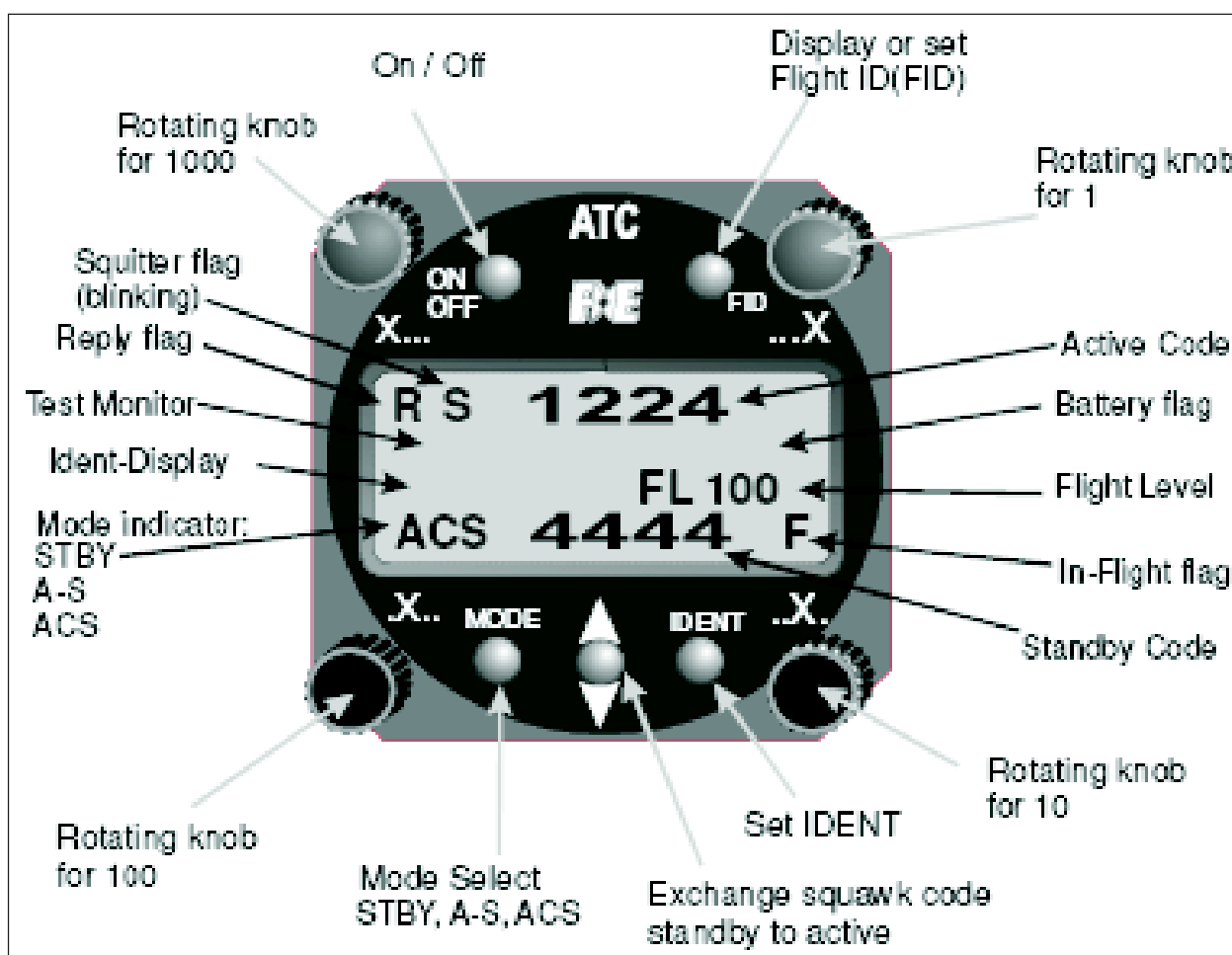

912.1.1 FRONT PANEL OPERATION

The input elements consist of four rotating knobs and five push buttons.

## ROTATING KNOBS

Four rotating knobs are used to select the IDENT CODE.

The assignments **X... , .X.. , ..X. , ...X** indicate the position of the code number set by each knob.

## PUSH BUTTONS

### ON OFF

The unit can be turned on by pressing the **ON OFF** button for less than 1 second.  
The unit can be turned off by pressing the **ON OFF** button for more than 2 seconds.  
(also refer to the System Operation Paragraph 912.1.2).

### MODE

The following modes can be selected in sequence by pressing the **MODE** button:

STBY Standby Mode used for aircraft on ground with reduced squitter rate, only Mode S with altitude reporting all ZERO only

A-S Mode A active with Mode C frames only and Mode S with altitude reporting all ZERO only

ACS Mode A ,C and S full active

### ARROWS UP AND DOWN

To activate the inserted SQUAWK CODE from the lower standby line to the upper active position the button with the **UP AND DOWN ARROWS** shall be pressed.

### IDENT

The **IDENT** push button causes the special position identification pulse (SPI) to be transmitted for a period of 18 seconds.

### FID

In the Standby Mode, the Aircraft Identification (Flight Identification) and Aircraft Address can be checked by pressing the push button **FID**. The Flight Identification is displayed on the right side of the lower line. By pressing the button **FID** for more than 3 seconds the input mode can be set or the Flight Identification can be changed.

## FLAGS

### Squitter Flag

When the extended squitter is active the letter **'S'** is displayed on the left top side of the display. As the squitter is a periodic signal, the displayed **'S'** is blinking.

### Reply Flag

In case of the transponder replying to interrogations the letter **'R'** is displayed on the left top side of the display.

### **In-Flight Flag**

When there is an undercarriage switch installed, the display can toggle between the letters '**F**' whether the aircraft is in flight condition or the letter '**G**' whether the aircraft is in „on-ground“ condition. The flag is displayed on the right bottom side of the display.

### **Battery Flag**

If the power supply to the transponder drops below 10 Volts, the flag '**BAT**' appears and starts flashing.

## **912.1.2 SYSTEM OPERATION**

The transponder should be turned off before starting and shutting down aircraft engines.

### **ON /OFF**

After having switched on the **AVIONIC MASTER** switch the TRT 800 has to be turned on by hand by pressing the **ON OFF** button for less than 1 second. The display will first show the transponder type and the software and firmware version. To turn off the unit the button **ON/OFF** must be pressed for more than two seconds or the **AVIONIC MASTER** switch must be placed to the **OFF**-position. ACS is the default operation mode and the transponder replies to Mode A,C and S interrogations. The pressure altitude will be displayed as Flight Level.

## **SQUAWK SELECTION**

Squawk selection is done with the four rotating knobs to provide 4096 identification codes. The assignments of the knobs, starting at top left, are:

- X...** selection of thousands (0-7)
- .X...** selection of hundreds (0-7)
- ..X.** selection of ten (0-7)
- ...X** selection of one (0-7)

The code is entered in the lower line and remains inactive. By pushing the **UP AND DOWN ARROWS** button the squawk code is transferred to the upper line and becomes active. The code in the upper line is always the active one.

## **IMPORTANT CODES:**

- 1200 The VFR code for any altitude in the US (Refer to ICAO standards elsewhere)
- 7000 The VFR code commonly used in Europe (Refer to ICAO standards)
- 0021 The VFR code commonly used in Germany (default is set to 0021 at time of installation)
- 7500 Hijack code (Aircraft is subject to unlawful interference)
- 7600 Loss of communications
- 7700 Emergency

7777 Military interceptor operations (Never squawk this code)

0000 Military use (Not enterable)

Care should be taken not to select the code 7500 and all codes in the 7600-7777 range, which trigger special indicators in automated facilities. Only the code 7500 will be decoded as the hijack code. An aircraft's transponder code (if available) is utilized to enhance the tracking capabilities of the ATC facility, therefore care should be taken when making routine code changes.

## STANDBY MODE

The standby mode is activated by pressing the **MODE** button once. This sets '**STBY**' in the mode indicator field. The transponder will now only reply to direct addressed Mode S interrogations. The squitter stays active at a lower rate.

## ALTITUDE OFF

Switching off altitude reporting will be necessary if the ATC controller requests it. For switching off altitude reporting the **MODE** button has to be pressed until '**A-S**' is displayed. The altitude display shows '**FL —**' to indicate that the altitude reporting is not active. Now the transponder will reply on Mode C interrogations with Mode C frames only and Mode S interrogations with FL000 (= 0000ft) instead of the actual altitude.

## IDENT

Pressing the **IDT** push button causes the special position identification pulse (SPI) to be appended to the Mode A replies for a period of 18 seconds and sets '**IDT**' in the display.

## LOW POWER SUPPLY

If the power supply to the transponder drops below 10 Volts, the flag '**BAT**' appears and starts flashing.

## DISPLAYING AIRCRAFT ADDRESS AND FLIGHT IDENTIFICATION

By pressing, the **FID** button for less than 3 seconds, while the unit is in Standby-mode, the left side of the bottom line will show the aircraft address.

### NOTE

**Only an authorized service station is allowed to enter or change the ICAO aircraft address. If you do not have the ICAO aircraft address. Please refer to your national aviation authority to apply for your aircraft address.**

The Aircraft Identification (FID) code is displayed on the right bottom line and consists of seven alphanumerical characters.

### CAUTION

**The ICAO Flight Plan specifies only 7 characters as Flight Identification. Filser reserves 8 characters as stated in ED- 73B for further expansion of the flight plan. The user shall only program 7 characters for FID.**

## SELECTING FLIGHT IDENTIFICATION

By pressing the button **FID** for more than 3 seconds, the unit will change into the Flight Identification input menu. This FID code is a changeable alphanumerical flight number. The right lower knob is used to set the cursor position (flashing ^) and with the left lower knob the figures A..Z, blank, and 0..9 can be selected. To enter the code, press the **MODE** button or the **FID** button again. The FID code is stored in the external aircraft connector.

- a. Factory setting for the FID is '**ZZZZZZZ**'
- b. The authorized service station should program a default FID that can be the tail-number of the aircraft.
- c. The pilot has to change the FID manually if necessary.

### 912.1.3 ERROR REPORTING / FAULT CODES

The transponder's reception, transmission, altitude and power supply are monitored periodically. This self-testing routine is permanently active in the background. If any error occurs due to an internal malfunction or from an external disturbance at the antenna, the transponder changes to the Standby mode and '**Error**' is displayed on the lowest line. Additionally the result of the internal analysis are displayed in the second line.

## LIST OF POSSIBLE ERRORS

1. '**ANT**' will appear if the antenna is defective (e.g. broken cable).
2. '**FLerr**' instead of the altitude appears on the display, if there is an error with the altimeter or if the aircraft is outside the altitude range(FL-010 to FL350). If the mode ACS was active before, it will change to mode A-S automatically.
3. '**DC**' for a faulty transmitter power supply
4. '**FPG**' for internal communication errors,
5. '**TRX**' will appear for transmitter error. In this case, the unit will change to '**STBY**' and will stop all transmission.

To meet ICAO specifications the TRT 600 uses an external memory inside the aircraft connector housing of the cable set, which is a part of the aircraft. Because this cable is installed permanent into the aircraft, a change of the transponder will not affect the aircraft address and the Flight ID. In the event there is a Cradle error, (empty memory or data error) **'OUT OF ORDER'** will be displayed. The first line shows which kind of error is present:

**'Cradle OFF'** displayed means no or defective data.

**'Cradle Data'** displayed means digital checksum error.

After a few seconds the display shows normal operating condition but with inhibited Mode S. The transponder will work with Mode A/C only. You will need to consult an authorized service station to enter the ICAO aircraft address (see TRT 600 Installation Manual). Please consult your airworthiness authority for national procedures.

**NOTE**

**If no valid ICAO 24 bit aircraft address is programmed to the unit or if the memory is inoperative the transponder will inhibit the Mode S functions. In this case only Mode A/C function will be available.**

**912.2 LIMITATIONS**

Not applicable

**912.3 EMERGENCY PROCEDURES**

The following emergency codes should be noted:

**7500** Hijacking

**7600** Loss of communication

**7700** Emergency

**912.4 NORMAL PROCEDURES**

Not applicable

**912.5 PERFORMANCE**

Not applicable

---

---

**SECTION 913**

**FILSER TRT 800 TRANSPONDER**

**Table of Contents**

<i>Paragraph</i>		<i>Page</i>
<b>913.1</b>	<b>GENERAL .....</b>	<b>913-3</b>
913.1.1	Front Panel Operation .....	913-3
913.1.2	System Operation .....	913-5
913.1.3	Error Reporting / Fault Codes .....	913-7
<b>913.2</b>	<b>LIMITATIONS .....</b>	<b>913-8</b>
<b>913.3</b>	<b>EMERGENCY PROCEDURES .....</b>	<b>913-8</b>
<b>913.4</b>	<b>NORMAL PROCEDURES .....</b>	<b>913-8</b>
<b>913.5</b>	<b>PERFORMANCE .....</b>	<b>913-8</b>

**Left blank intentionally**

### 913.1 GENERAL

The TRT 800 is Level 2es Class2 (SSR Mode S Elementary and Enhanced Surveillance) Transponder. It has Mode A, Mode A/C and Mode S capability. In Mode S the transponder provides acquisition and extended squitter capability. Furthermore, the TRT 800 has a built-in barometric pressure altitude coder in 100 ft increments.

**NOTE**

Refer to latest edition of Filser TRT 800 Pilot's Operation Manual (Doc. No. 03.210.010.11) to get familiar with the TRT 800 Transponder.

The following illustration of the front panel of the TRT 800 will assist the operator to understand this Mode S Transponder.

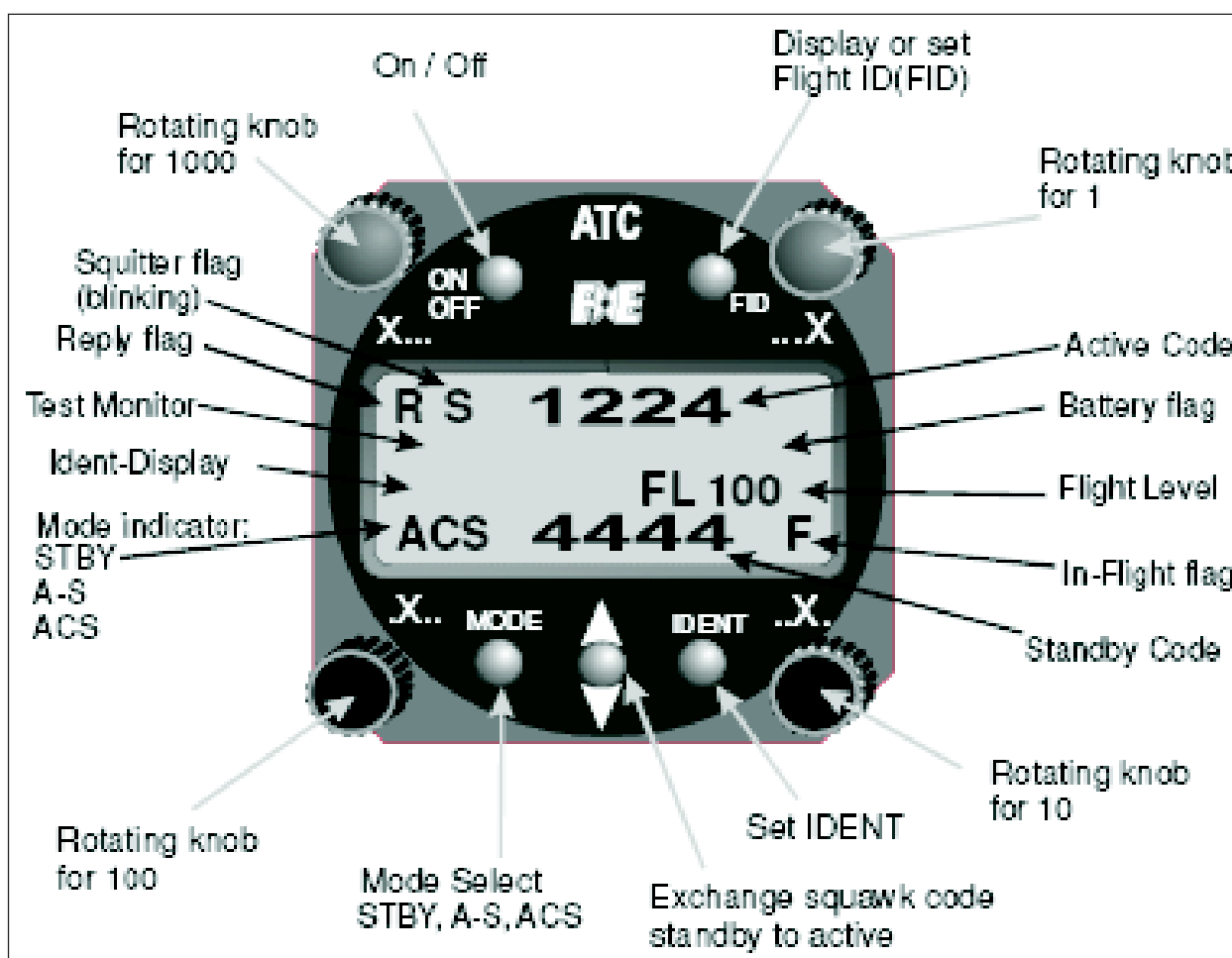

#### 913.1.1 FRONT PANEL OPERATION

The input elements consist of four rotating knobs and five push buttons.

## ROTATING KNOBS

Four rotating knobs are used to select the IDENT CODE.

The assignments **X... , .X.. , ..X. , ...X** indicate the position of the code number set by each knob.

## PUSH BUTTONS

### ON OFF

The unit can be turned on by pressing the **ON OFF** button for less than 1 second. The unit can be turned off by pressing the **ON OFF** button for more than 2 seconds. (also refer to the System Operation Paragraph 913.1.2)

### MODE

The following modes can be selected in sequence by pressing the **MODE** button:

STBY Standby Mode used for aircraft on ground with reduced squitter rate, only Mode S with altitude reporting all ZERO only

A-S Mode A active with Mode C frames only and Mode S with altitude reporting all ZERO only

ACS Mode A ,C and S full active

### ARROWS UP AND DOWN

To activate the inserted SQUAWK CODE from the lower standby line to the upper active position the button with the **UP AND DOWN ARROWS** shall be pressed.

### IDENT

The **IDENT** push button causes the special position identification pulse (SPI) to be transmitted for a period of 18 seconds.

### FID

In the Standby Mode, the Aircraft Identification (Flight Identification) and Aircraft Address can be checked by pressing the push button **FID**. The Flight Identification is displayed on the right side of the lower line. By pressing the button **FID** for more than 3 seconds the input mode can be set or the Flight Identification can be changed.

## FLAGS

### SQUITTER FLAG

When the extended squitter is active the letter **'S'** is displayed on the left top side of the display. As the squitter is a periodic signal, the displayed **'S'** is blinking.

### REPLY FLAG

In case of the transponder replying to interrogations the letter **'R'** is displayed on the left top side of the display.

### IN-FLIGHT FLAG

When there is an undercarriage switch installed, the display can toggle between the letters '**F**' whether the aircraft is in flight condition or the letter '**G**' whether the aircraft is in „on-ground“ condition. The flag is displayed on the right bottom side of the display.

### BATTERY FLAG

If the power supply to the transponder drops below 10 Volts, the flag '**BAT**' appears and starts flashing.

## 913.1.2 SYSTEM OPERATION

The transponder should be turned off before starting and shutting down aircraft engines.

### ON /OFF

After having switched on the **AVIONIC MASTER** switch the TRT 800 has to be turned on by hand by pressing the **ON OFF** button for less than 1 second. The display will first show the transponder type and the software and firmware version. To turn off the unit the button **ON/OFF** must be pressed for more than two seconds or the **AVIONIC MASTER** switch must be placed to the **OFF** position. ACS is the default operation mode and the transponder replies to Mode A,C and S interrogations. The pressure altitude will be displayed as Flight Level.

## SQUAWK SELECTION

Squawk selection is done with the four rotating knobs to provide 4096 identification codes. The assignments of the knobs, starting at top left, are:

- X...** selection of thousands (0-7)
- .X...** selection of hundreds (0-7)
- ..X.** selection of ten (0-7)
- ...X** selection of one (0-7)

The code is entered in the lower line and remains inactive. By pushing the **UP AND DOWN ARROWS** button the squawk code is transferred to the upper line and becomes active. The code in the upper line is always the active one.

## IMPORTANT CODES:

- 1200 The VFR code for any altitude in the US (Refer to ICAO standards elsewhere)
- 7000 The VFR code commonly used in Europe (Refer to ICAO standards)
- 0021 The VFR code commonly used in Germany (default is set to 0021 at time of installation)
- 7500 Hijack code (Aircraft is subject to unlawful interference)
- 7600 Loss of communications

7700 Emergency

7777 Military interceptor operations (Never squawk this code)

0000 Military use (Not enterable)

Care should be taken not to select the code 7500 and all codes in the 7600-7777 range, which trigger special indicators in automated facilities. Only the code 7500 will be decoded as the hijack code. An aircraft's transponder code (if available) is utilized to enhance the tracking capabilities of the ATC facility, therefore care should be taken when making routine code changes.

### **STANDBY MODE**

The standby mode is activated by pressing the MODE button once. This sets **'STBY'** in the mode indicator field. The transponder will now only reply to direct addressed Mode S interrogations. The squitter stays active at a lower rate.

### **ALTITUDE OFF**

Switching off altitude reporting will be necessary if the ATC controller requests it. For switching off altitude reporting the **MODE** button has to be pressed until **'A-S'** is displayed. The altitude display shows **'FL —'** to indicate that the altitude reporting is not active. Now the transponder will reply on Mode C interrogations with Mode C frames only and Mode S interrogations with FL000 (= 0000ft) instead of the actual altitude.

### **IDENT**

Pressing the **IDT** push button causes the special position identification pulse (SPI) to be appended to the Mode A replies for a period of 18 seconds and sets **'IDT'** in the display.

### **LOW POWER SUPPLY**

If the power supply to the transponder drops below 10 Volts, the flag **'BAT'** appears and starts flashing.

### **DISPLAYING AIRCRAFT ADDRESS AND FLIGHT IDENTIFICATION**

By pressing, the **FID** button for less than 3 seconds, while the unit is in Standby-Mode, the left side of the bottom line will show the aircraft address.

#### **NOTE**

**Only an authorized service station is allowed to enter or change the ICAO aircraft address. If you do not have the ICAO aircraft address. Please refer to your national aviation authority to apply for your aircraft address.**

The Aircraft Identification (FID) code is displayed on the right bottom line and consists of seven alphanumerical characters.

### CAUTION

**The ICAO Flight Plan specifies only 7 characters as Flight Identification. Filser reserves 8 characters as stated in ED- 73B for further expansion of the flight plan. The user shall only program 7 characters for FID.**

### SELECTING FLIGHT IDENTIFICATION

By pressing the button **FID** for more than 3 seconds, the unit will change into the Flight Identification input menu. This FID code is a changeable alphanumerical flight number. The right lower knob is used to set the cursor position (flashing ^) and with the left lower knob the figures A..Z, blank, and 0..9 can be selected. To enter the code, press the **MODE** button or the **FID** button again. The FID code is stored in the external aircraft connector.

- a. Factory setting for the FID is '**ZZZZZZZ**'
- b. The authorized service station should program a default FID that can be the tail-number of the aircraft.
- c. The pilot has to change the FID manually if necessary.

### 913.1.3 ERROR REPORTING / FAULT CODES

The transponder's reception, transmission, altitude and power supply are monitored periodically. This self-testing routine is permanently active in the background. If any error occurs due to an internal malfunction or from an external disturbance at the antenna, the transponder changes to the Standby Mode and „**Error**“ is displayed on the lowest line. Additionally the result of the internal analysis are displayed in the second line.

#### LIST OF POSSIBLE ERRORS:

1. '**ANT**' will appear if the antenna is defective (e.g. broken cable).
2. '**FLerr**' instead of the altitude appears on the display, if there is an error with the altimeter or if the aircraft is outside the altitude range(FL-010 to FL350). If the mode ACS was active before, it will change to mode A-S automatically.
3. '**DC**' for a faulty transmitter power supply
4. '**FPG**' for internal communication errors,
5. '**TRX**' will appear for transmitter error. In this case, the unit will change to '**STBY**' and will stop all transmission.

To meet ICAO specifications the TRT 800 uses an external memory inside the aircraft connector housing of the cable set, which is a part of the aircraft. Because this cable is installed permanent into the aircraft, a change of the transponder will not affect the aircraft address and the Flight ID. In the event there is a Cradle error, (empty memory or data error) „OUT OF ORDER“ will be displayed. The first line shows which kind of error is present:

**'Cradle OFF'** displayed means no or defective data.

**'Cradle Data'** displayed means digital checksum error.

After a few seconds the display shows normal operating condition but with inhibited Mode S. The transponder will work with Mode A/C only. You will need to consult an authorized service station to enter the ICAO aircraft address (see TRT800 Installation Manual). Please consult your airworthiness authority for national procedures.

**NOTE**

**If no valid ICAO 24 bit aircraft address is programmed to the unit or if the memory is inoperative the transponder will inhibit the Mode S functions. In this case only Mode A/C function will be available.**

**913.2 LIMITATIONS**

Not applicable.

**913.3 EMERGENCY PROCEDURES**

The following emergency codes should be noted:

7500 Hijacking

7600 Loss of communication

7700 Emergency

**913.4 NORMAL PROCEDURES**

Not applicable.

**913.5 PERFORMANCE**

Not applicable.

---

---

**SECTION 914**

**GARMIN GTX 327 TRANSPONDER**

**Table of Contents**

<i>Paragraph</i>		<i>Page</i>
<b>914.1</b>	<b>GENERAL .....</b>	<b>914-3</b>
914.1.1	Mode Selection Keys .....	914-3
914.1.2	Code Selection .....	914-4
914.1.3	Keys for other GTX 327 Functions .....	914-4
<b>914.2</b>	<b>LIMITATIONS .....</b>	<b>914-5</b>
<b>914.3</b>	<b>EMERGENCY PROCEDURES .....</b>	<b>914-6</b>
914.3.1	Important Codes .....	914-6
<b>914.4</b>	<b>NORMAL PROCEDURES .....</b>	<b>914-6</b>
<b>914.5</b>	<b>PERFORMANCE .....</b>	<b>914-6</b>

**Left blank intentionally**

## 914.1 GENERAL

The GARMIN GTX 327 is a panel-mounted TSO.d transponder with the addition of timing functions. The transponder is a radio transmitter and receiver that operates on radar frequencies, receiving ground radar interrogations at 1030 MHz and transmitting a coded response of pulses to ground-based radar on a frequency of 1090 MHz.



### NOTE

The GTX 327 owner accepts all responsibility for obtaining the proper license before using the transponder.

The coverage you can expect from the GTX 327 is limited to „line of sight“. Low altitude or aircraft antenna shielding by the aircraft itself may result in reduced range. Range can be improved by climbing to a higher altitude. It may be possible to minimize antenna shielding by locating the antenna where dead spots are only noticed during abnormal flight attitudes.

### CAUTION

The GTX 327 should be turned off before starting or shutting down aircraft engine.

The GTX 327 Transponder is powered on by pressing the **STBY**, **ALT** or **ON** keys, or by the **AVIONIC MASTER** switch. After power on a start-up page will be displayed while the unit performs a self test.

### 914.1.1 MODE SELECTION KEYS

#### OFF

Powers off the GTX 327.

#### STBY

Powers on the transponder in standby mode. At power on the last active identification code will be selected. When in standby mode, the transponder will not reply to any interrogations.

#### ON

Powers on the transponder in Mode A. At power on the last active identification code will be selected. In this mode the transponder replies to interrogations, as indicated by the Reply Symbol. Replies do not include altitude information.

#### ALT

Powers on the transponder in Mode A and Mode C. At power on the last active identification code will be selected. In ALT mode, the transponder replies to identification and altitude interrogations, as indicated by the Reply Symbol. Replies to altitude interrogations include standard pressure altitude received from a separate encoder.

### 914.1.2 CODE SELECTION

Code selection is done with eight keys (**0 - 7**) that provide 4,096 active identification codes. Pushing one of these keys begins the code selection sequence. The new code will not be activated until the fourth digit is entered. Pressing the **CLR** key will move the cursor back to the previous digit. Pressing the **CLR** key when the cursor is on the first key of the code, or pressing the **CRSR** key during code entry, will remove the cursor and cancel data entry, restoring the previous code. The numbers **8** and **9** are not used for code entry, only for entering a Count Down time, and in Configuration Mode.

#### IMPORTANT CODES:

1200 The VFR code for any altitude in the US (Refer to ICAO standards elsewhere)

7000 The VFR code commonly used in Europe (Refer to ICAO standards)

0021 The VFR code commonly used in Germany (default is set to 0021 at time of installation)

7500 Hijack code (Aircraft is subject to unlawful interference)

7600 Loss of communications

7700 Emergency

7777 Military interceptor operations (Never squawk this code)

0000 Military use (Not enterable)

Care should be taken not to select the code 7500 and all codes in the 7600-7777 range, which trigger special indicators in automated facilities. Only the code 7500 will be decoded as the hijack code. An aircraft's transponder code (if available) is utilized to enhance the tracking capabilities of the ATC facility, therefore care should be taken when making routine code changes.

### 914.1.3 KEYS FOR OTHER GTX 327 FUNCTIONS

#### IDENT

Pressing the **IDENT** key activates the Special Position Identification (SPI) Pulse for 18 seconds, identifying your transponder return from others on the air traffic controller's screen. The word '**IDENT**' will appear in the upper left corner of the display while the IDENT mode is active.

#### VFR

Sets the transponder code to the pre-programmed VFR code selected in the Configuration Mode. Pressing the **VFR** key again will restore the previous identification code.

#### START/STOP

Starts and stops the Count Up and Count Down timers.

#### CRSR

Initiates entry of starting time for the Count Down timer and cancels transponder code entry.

**CLR**

Resets the Count Up and Count Down timers and cancels the previous keypress during code selection.

**8**

Reduces Contrast and Display Brightness when the respective pages are displayed. Also enters the number eight into the Count Down timer.

**9**

Increases Contrast and Display Brightness when the respective pages are displayed. Also enters the number nine into the Count Down timer.

**FUNC**

Changes the page shown on the right side of the display. Displayed data includes Pressure Altitude, Flight Time, Count Up timer, Count Down timer, and may include Contrast and Display Brightness, depending on configuration (refer to the screen description below):

**SCREEN DESCRIPTION:**

**'PRESSURE ALT'**

Displays the altitude data supplied to GTX 327 in feet, hundreds of feet (i.e., flight level), or meters, depending on configuration.

**'FLIGHT TIME'**

Displays the Flight Time, which is controlled by the **START/STOP** key.

**'COUNT UP TIMER'**

Controlled by the **START/STOP** and **CLR** keys.

**'COUNT DOWN TIMER'**

Controlled by **START/STOP**, **CLR**, and **CRSR** keys. The initial Count Down time is entered with the **0 - 9** keys.

**'CONTRAST'**

This page is only displayed if manual contrast mode is selected in Configuration Mode. Contrast is controlled by the **8** and **9** keys.

**'DISPLAY'**

This page is only displayed if manual backlighting mode is selected on Configuration Mode. Backlighting is controlled by the **8** and **9** keys.

**914.2 LIMITATIONS**

Not applicable.

### **914.3 EMERGENCY PROCEDURES**

#### **914.3.1 IMPORTANT CODES**

7600 Loss of communications.

7500 Hijacking.

7700 Emergency (All secondary surveillance radar sites are ready to receive this code at all times).

See the Airman's Information Manual (AIM) for a detailed explanation of identification codes.

#### **914.4 NORMAL PROCEDURES**

Not applicable.

#### **914.5 PERFORMANCE**

Not applicable.

---

---

**SECTION 915**

**GARMIN GTX 330 TRANSPONDER**

**Table of Contents**

<i>Paragraph</i>		<i>Page</i>
<b>915.1</b>	<b>GENERAL .....</b>	<b>915-3</b>
915.1.1	Mode Selection Keys .....	915-4
915.1.2	Code Selection .....	915-4
915.1.3	Keys for other GTX 330 Functions .....	915-5
915.1.4	Function Display .....	915-5
915.1.5	Configuration Mode .....	915-6
915.1.6	Altitude trend indicator .....	915-6
915.1.7	Failure Annunciation .....	915-6
<b>915.2</b>	<b>LIMITATIONS .....</b>	<b>915-7</b>
<b>915.3</b>	<b>EMERGENCY PROCEDURES .....</b>	<b>915-7</b>
915.3.1	Important Codes .....	915-7
<b>915.4</b>	<b>NORMAL PROCEDURES .....</b>	<b>915-7</b>
<b>915.5</b>	<b>PERFORMANCE .....</b>	<b>915-7</b>

**Left blank intentionally**

## 915.1 GENERAL

The Garmin GTX 330 panel mounted Mode S Transponder is a radio transmitter and receiver that fulfills the role of the airborne beacon equipment according to the requirements of the Air Traffic Radar Beacon System (ATCRBS). Its functionality includes replying to ATCRBS Mode A and C and Mode S interrogations. The Mode S function will allow the ground station to individually select the aircraft by its Aircraft Address assigned to the aircraft by the aviation agency.



It operates on radar frequencies, receiving ground radar interrogations at 1030 MHz and transmitting a coded response of pulses to ground-based radar on a frequency of 1090 MHz. The GTX 330 is equipped with IDENT capability that activates the Special Position Identification (SPI) pulse for 18 seconds. Mode S transmit/receive capability also requires 1090 MHz transmitting and 1030 MHz receiving for Mode S functions.

In addition to displaying the code, reply symbol and mode of operation, the GTX 330 screen will display pressure altitude and timer functions. The displayed pressure altitude may not agree with the aircraft's baro-corrected altitude under non standard conditions. The unit also features flight timers.

The Traffic Information Service (TIS) is not available in this installation.

### NOTE

**The GTX 330 owner accepts all responsibility for obtaining the proper license before using the transponder.**

The coverage you can expect from the GTX 330 is limited to „line of sight“. Low altitude or aircraft antenna shielding by the aircraft itself may result in reduced range. Range can be improved by climbing to a higher altitude. It may be possible to minimize antenna shielding by locating the antenna where dead spots are only noticed during abnormal flight attitudes.

### CAUTION

**The GTX 330 should be turned off before starting or shutting down aircraft engine.**

The GTX 330 Transponder is automatically powered on by the respective **AVIONIC MASTER** switch or when previously manually powered off while **AVIONIC MASTER** switch is on by pressing the **STBY**, **ALT** or **ON** keys. After power on, a start-up page will be displayed while the unit performs a self test.

### 915.1.1 MODE SELECTION KEYS

#### **OFF**

Powers off the GTX 330.

#### **STBY**

Selects the standby mode displaying the last active identification code. When in standby mode, the transponder will not reply to any interrogations.

#### **ON**

Selects Mode A. At power on the last active identification code will be selected. In this mode the transponder replies to interrogations, as indicated by the Reply Symbol. Replies do not include altitude information.

#### **ALT**

Powers on the transponder in Mode A and Mode C. At power on the last active identification code will be selected. In ALT mode, the transponder replies to identification and altitude interrogations, as indicated by the Reply Symbol. Replies to altitude interrogations include standard pressure altitude received from a separate encoder.

### 915.1.2 CODE SELECTION

Code selection is done with eight keys (**0 - 7**) that provide 4,096 active identification codes. Pushing one of these keys begins the code selection sequence. The new code will not be activated until the fourth digit is entered. Pressing the **CLR** key will move the cursor back to the previous digit. Pressing the **CLR** key when the cursor is on the first key of the code, or pressing the **CRSR** key during code entry, will remove the cursor and cancel data entry, restoring the previous code. You may press the **CLR** key up to five seconds after code entry is complete to return the cursor to the fourth digit. The numbers **8** and **9** are not used for code entry, only for entering a Count Down time, contrast and display brightness, and in the Configuration Mode.

#### **IMPORTANT CODES:**

- 1200 The VFR code for any altitude in the US (Refer to ICAO standards elsewhere)
  - 7000 The VFR code commonly used in Europe (Refer to ICAO standards)
  - 0021 The VFR code commonly used in Germany (default is set to 0021 at time of installation)
  - 7500 Hijack code (Aircraft is subject to unlawful interference)
  - 7600 Loss of communications
  - 7700 Emergency
  - 7777 Military interceptor operations (Never squawk this code)
  - 0000 Military use (Not enterable)
-

Avoid selecting code 7500 and all codes in the 7600-7777 range. These trigger special indicators in automated facilities. Only the code 7500 will be decoded as the hijack code. An aircraft's transponder code (if available) is utilized to enhance the tracking capabilities of the ATC facility, therefore care should be taken when making routine code changes.

### 915.1.3 KEYS FOR OTHER GTX 330 FUNCTIONS

#### **IDENT**

Pressing the IDENT key activates the Special Position Identification (SPI) Pulse for 18 seconds, identifying your transponder return from others on the air traffic controller's screen. The word 'IDENT' will appear in the upper left corner of the display while the IDENT mode is active.

#### **VFR**

Pressing the VFR key sets the transponder code to the pre-programmed VFR code selected in the Configuration Mode. Pressing the VFR key again will restore the previous identification code.

#### **FUNC**

Pressing the FUNC key changes the page shown on the right side of the display. Displayed data includes Pressure Altitude, Flight Time, Count Up timer, Count Down timers. In the Configuration Mode, steps through function pages.

#### **START/STOP**

Starts and stops the Count Up, Count Down and flight timers. In the Configuration Mode, steps through functions in reverse.

#### **CRSR**

Initiates starting time entry for the Count Down timer and cancels transponder code entry. Returns cursor to last code digit within five seconds after entry. Selects changeable fields in Configuration Mode.

#### **CLR**

Resets the Count Up and Count Down timers. Cancels the previous keypress during code selection and Count Down entry. Returns cursor to last code digit within five seconds after entry. Used in Configuration Mode.

#### **8**

Reduces Contrast and Display Brightness when the respective pages are displayed and enters the number eight into the Count Down timer. Used in Configuration Mode.

#### **9**

Increases Contrast and Display Brightness when the respective pages are displayed. Also enters the number nine into the Count Down timer. Used in Configuration Mode.

### 915.1.4 FUNCTION DISPLAY

#### **'PRESSURE ALT'**

Displays the altitude data supplied to GTX 330 in feet, hundreds of feet (i.e., flight level), or meters, depending on configuration. An arrow to the right of the altitude indicates that the airplane is climbing or descending.

**'FLIGHT TIME'**

Displays the Flight Time controlled by the **START/STOP** and **CLR** keys when Automated Airborne Determination is configured as normal.

**'ALTITUDE MONITOR'**

The ALTITUDE MONITOR function is not available in this installation.

**'OAT/DALT'**

The OAT/DALT function is not available in this installation (no temperature input).

**'COUNT UP TIMER'**

The count up timer is controlled by the **START/STOP** and **CLR** keys. Pressing the **CLR** key zeros the display.

**'COUNT DOWN TIMER'**

The count down timer is controlled by **START/STOP**, **CLR**, and **CRSR** keys. The initial Count Down time is entered with the **0 - 9** keys. Pressing the **CLR** key resets the timer to the initial value.

**'STBY'**

The transponder will not reply to any interrogations.

**'GND'**

This page is not active.

**'CONTRAST'**

This page is only displayed if manual contrast mode is selected in Configuration Mode. Contrast is controlled by the **8** and **9** keys.

**'DISPLAY'**

This page is only displayed if manual backlighting mode is selected on Configuration Mode. Backlighting is controlled by the **8** and **9** keys.

### 915.1.5 CONFIGURATION MODE

The configuration is normally set at time of installation, including the unique Mode S aircraft address. The configuration Mode should not be used during flight. Refer to the GTX 330 Pilot's Guide PN 190-00207-00 latest revision.

### 915.1.6 ALTITUDE TREND INDICATOR

When the **'PRESSURE ALT'** page is displayed, an arrow is displayed to the right of the altitude, indicating that the altitude is increasing or decreasing. One of two sizes of arrows is displayed depending on the rate of climb/&descent. The sensitivity of these arrows is set using the Configuration Mode vertical speed rate.

### 915.1.7 FAILURE ANNUNCIATION

If the unit detects an internal failure, the screen displays **'FAIL'**.

**915.2 LIMITATIONS**

Not applicable.

**915.3 EMERGENCY PROCEDURES**

**915.3.1 IMPORTANT CODES**

7600 Loss of communications.

7500 Hijacking.

7700 Emergency (All secondary surveillance radar sites are ready to receive this code at all times).

See the Airman's Information Manual (AIM) for a detailed explanation of identification codes.

**915.4 NORMAL PROCEDURES**

Not applicable.

**915.5 PERFORMANCE**

Not applicable.

**Left blank intentionally**

---

---

**SECTION 916**

**BENDIX/KING KT 76A TRANSPONDER**

**Table of Contents**

<i>Paragraph</i>		<i>Page</i>
<b>916.1</b>	<b>GENERAL .....</b>	<b>916-3</b>
916.1.1	Code Selection .....	916-3
916.1.2	Reply Light .....	916-4
916.1.3	Testing the KT 76A .....	916-4
<b>916.2</b>	<b>LIMITATIONS .....</b>	<b>916-4</b>
<b>916.3</b>	<b>EMERGENCY PROCEDURE .....</b>	<b>916-4</b>
<b>916.4</b>	<b>NORMAL PROCEDURE: .....</b>	<b>916-5</b>
916.4.1	Squawk Ident .....	916-5
<b>916.5</b>	<b>PERFORMANCE .....</b>	<b>916-5</b>

**Left blank intentionally**

## 916.1 GENERAL

The BENDIX/KING KT 76A panel mounted transponder receives interrogations at 1030 MHz, and these trigger a coded response of radar pulses, which are transmitted back to ATC at 1090 MHz. The return reinforces your aircraft's image or „blip“ on the controller's radar screen.

The KT 76A can reply to radar in any of 4096 preselected codes. Each code is identified by a unique group of pulses. With either an separate encoder, the KT 76A also provides ground radar with a continuous report of your altitude, which are automatically updated in 100-foot increments.

### NOTE

**The KT 76A owner accepts all responsibility for obtaining the proper license before using the transponder.**

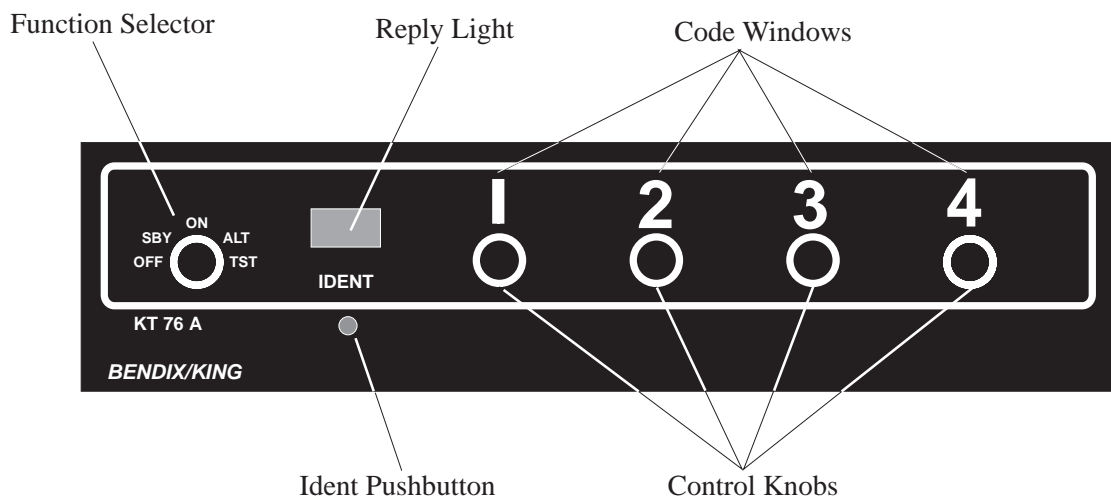

### 916.1.1 CODE SELECTION

The Identification Code selection is done with 4 ATRBS Code Selector Knobs that provide 4,096 active identification codes. Each of the 4 Code Selector Knobs selects a separate digit of the identification code. There is no need to move the „caret“ back to the first digit; it will automatically return after about five seconds. The KT 76A will retain the reply code through power shutdowns if the code has not been changed during the 5 seconds prior to removing power.

#### IMPORTANT CODES:

- 1200 The VFR code for any altitude in the US (Refer to ICAO standards elsewhere)
- 7000 The VFR code commonly used in Europe (Refer to ICAO standards)
- 0021 The VFR code commonly used in Germany (default is set to 0021 at time of installation)
- 7500 Hijack code (Aircraft is subject to unlawful interference)

7600 Loss of communications

7700 Emergency

7777 Military interceptor operations (Never squawk this code)

0000 Military use (Not enterable)

Avoid selecting code 7500 and all codes in the 7600-7777 range. These trigger special indicators in automated facilities. Only the code 7500 will be decoded as the hijack code. An aircraft's transponder code (if available) is utilized to enhance the tracking capabilities of the ATC facility, therefore care should be taken when making routine code changes.

### 916.1.2 REPLY LIGHT

During normal operation, the flashing Reply Light indicates that the KT 76A is functioning properly and replying to interrogations from ground radar. Interrogations occur at 10-15 second intervals, corresponding to each radar sweep. Frequently, the reply light will blink almost continuously, meaning that the transponder is responding to interrogations from several radar stations.

### 916.1.3 TESTING THE KT 76A

Allow a warm-up time of about 25 sec. before testing the KT 76A. Switching the function selector to the **TST** position a series of internal tests is performed to check the KT 76A. If no faults are detected the reply-light illuminates.

### 916.2 LIMITATIONS

Not Applicable.

### 916.3 EMERGENCY PROCEDURE

#### IMPORTANT CODES

7500	Use to report a hijacking.
7600	Signifies communication failure.
7700	Reserved for emergencies.

#### **916.4 NORMAL PROCEDURE**

After engine start-up, turn the function selector to the Standby (**SBY**) position. Then select the proper reply code by rotating the code select knobs.

As soon as aircraft is airborne, switch the function selector to **ON**. Your KT 76A is now operating in „Mode A“, or normal mode. To operate in „Mode C“, or altitude reporting mode, turn the function selector to **ALT** (if aircraft is equipped with altitude encoding equipment).

##### **916.4.1 SQUAWK IDENT**

When you are asked to „ident“ by ATC, briefly press the **IDENT** push-button. Your aircraft will be positively identified to the Air Traffic Controller.

#### **916.5 PERFORMANCE**

Not Applicable

**Left blank intentionally**

---

---

**SECTION 917**

**BENDIX/KING KT 73 TRANSPONDER**

**Table of Contents**

<i>Paragraph</i>		<i>Page</i>
<b>917.1</b>	<b>GENERAL .....</b>	<b>917-3</b>
917.1a	Function Selector Knob .....	917-4
917.1b	Code Selection .....	917-4
917.1c	Buttons/selectors for other KT 73 Functions .....	917-5
917.1d	Function Display .....	917-6
917.1e	Programming Mode .....	917-6
917.1f	Air/Ground Switching .....	917-6
917.1g	Failure Annunciation .....	917-7
<b>917.2</b>	<b>LIMITATIONS .....</b>	<b>917-7</b>
<b>917.3</b>	<b>EMERGENCY PROCEDURES .....</b>	<b>917-7</b>
<b>917.4</b>	<b>NORMAL PROCEDURES .....</b>	<b>917-7</b>
<b>917.5</b>	<b>PERFORMANCE .....</b>	<b>917-7</b>

**Left blank intentionally**

917.1 GENERAL

The BENDIX/KING KT 73 panel mounted Mode S Transponder is a radio transmitter and receiver that fulfills the role of the airborne beacon equipment according to the requirements of the Air Traffic Radar Beacon System (ATCRBS). Its functionality includes replying to ATCRBS Mode A and C and Mode S interrogations. The Mode S function will allow the ground station to individually select the aircraft by its Aircraft Address assigned to the aircraft by the aviation agency.

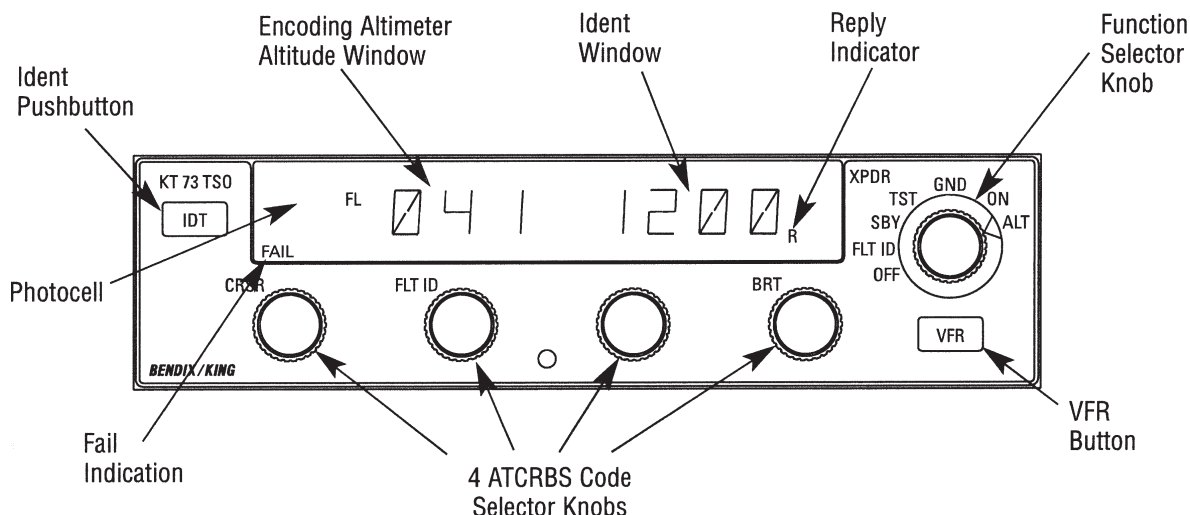

It operates on radar frequencies, receiving ground radar interrogations at 1030 MHz and transmitting a coded response of pulses to ground-based radar on a frequency of 1090 MHz.

The KT 73 is equipped with IDT (ident) capability that activates the Special Position Identification (SPI) pulse for 18 seconds.

In addition to displaying the code, reply symbol and mode of operation, the KT 73 screen will display pressure altitude. The displayed pressure altitude may not agree with the aircraft's baro-corrected altitude under non standard conditions.

The Traffic Information Service (TIS) and Automatic Dependent Surveillance-Broadcast (ADS-B) is not available in this installation.

**NOTE**

**The KT 73 owner accepts all responsibility for obtaining the proper license before using the transponder.**

The coverage you can expect from the KT 73 is limited to „line of sight“. Low altitude or aircraft antenna shielding by the aircraft itself may result in reduced range. Range can be improved by climbing to a higher altitude. It may be possible to minimize antenna shielding by locating the antenna where dead spots are only noticed during abnormal flight attitudes.

**CAUTION**

**The KT 73 should be turned off before starting or shutting down aircraft engine.**

The KT 73 Transponder is powered on by rotating the Function Selector Knob from the **OFF** position to any functional mode position.

## 917.1A FUNCTION SELECTOR KNOB

The following operating modes can be chosen by the Function Selector Knob:

### **OFF**

Powers off the KT 73. When the unit is turned to another mode, it will reply or squitter within two seconds, according to the selected mode.

### **FLT ID**

Selects the Flight ID mode displaying the 8 character Flight ID or registration marking of the airplane. When in Flight ID mode, the transponder will not reply to any interrogations.

### **SBY**

Selects the Standby mode displaying the last active identification code. When in Standby mode, the transponder is energized but will not reply to any interrogations.

### **TST**

Selects the Test mode displaying all display segments for a minimum of 4 seconds. A series of internal tests is performed to check its integrity, verify all aircraft specific configuration data and make hardware and squitter checks. When in Flight ID mode, the transponder will not reply to any interrogations. In addition the display brightness can be manually adjusted by rotating the **BRT** knob.

### **GND**

Selects the Ground mode displaying '**GND**' in the altitude window. When in Ground mode, the transponder will not reply to ATCRBS, ATCRBS/Modes S All-Call and Mode S-only All-Call interrogations. It will continue to generate Mode S squitter transmissions and reply to discretely addressed Mode S interrogations.

### **ON**

Powers on the transponder in Mode A, C and S. In this mode the transponder replies to interrogations, as indicated by the Reply Symbol. Replies do not include altitude information.

### **ALT**

Powers on the transponder in Mode A, C and Mode C. In ALT mode, the transponder replies to identification and altitude interrogations, as indicated by the Reply Symbol. Replies to altitude interrogations include standard pressure altitude received from a separate encoder.

## 917.1B CODE SELECTION

The Identification Code selection is done with 4 ATCRBS Code Selector Knobs that provide 4,096 active identification codes. Each of the 4 Code Selector Knobs selects a separate digit of the identification code.

### **IMPORTANT CODES:**

1200 The VFR code for any altitude in the US (Refer to ICAO standards elsewhere)

7000 The VFR code commonly used in Europe (Refer to ICAO standards)

0021 The VFR code commonly used in Germany (default is set to 0021 at time of installation)

7500 Hijack code (Aircraft is subject to unlawful interference)

7600 Loss of communications

7700 Emergency

7777 Military interceptor operations (Never squawk this code)

0000 Military use (Not enterable)

Changing the preset VFR code is done as follows:

Place the unit in SBY

Select the desired VFR code

While holding the **IDT** button in, momentarily press the **VFR** button.

Avoid selecting code 7500 and all codes in the 7600-7777 range. These trigger special indicators in automated facilities. Only the code 7500 will be decoded as the hijack code. An aircraft's transponder code (if available) is utilized to enhance the tracking capabilities of the ATC facility, therefore care should be taken when making routine code changes.

#### 917.1C BUTTONS/SELECTORS FOR OTHER KT 73 FUNCTIONS

##### **IDT**

Pressing the **IDT** (Ident) button while in the GND, ON or ALT mode activates the Special Position Identification (SPI) Pulse for 18 seconds, identifying your transponder return from others on the air traffic controller's screen. The word '**IDT**' will appear in the left lower corner of the altitude window while the IDT mode is active. When the Function Selector Knob in test mode (**TST**), pressing the **IDT** button will return the brightness to the default factory value.

##### **VFR**

Momentarily pressing the **VFR** Pushbutton sets the transponder code to the pre-programmed VFR code, superseding whatever code was previously entered. Pressing the **VFR** key again and holding it for two seconds will restore the previous identification code. When in TST mode pushing the **VFR** button will display the software revisions on the Altitude window and Ident window for a minimum of 4 seconds.

##### **FLT ID**

When in FLT ID mode, the flight ID can be entered or modified by rotating the **FLT ID** knob (= 2nd ATCRBS Code Selector Knob) to select desired character for each digit selected by the **CRSR** knob. Once the **CRSR** and **FLT ID** knobs have been idle for 5 seconds or the Function Selector Knob has been turned to the **SBY** position the flight ID will be saved.

##### **CRSR**

When in FLT ID mode, rotating the **CRSR** knob (= 1st ATCRBS Code Selector Knob) will position the cursor under the character of the flight ID to be changed.

### **BRT**

When in TST mode, rotating the **BRT** knob (= 4th ATRBS Code Selector Knob) will manually adjust the display brightness. Clockwise rotating will increase display brightness and counterclockwise will decrease display brightness. The brightness of the display is determined by a photocell relative to the programmed or manual adjusted brightness level.

## **917.1D FUNCTION DISPLAY**

### **'FL'**

When the ALT mode is selected, the letters **'FL'** will be illuminated. The pressure altitude data supplied to the KT 73 is displayed in hundreds of feet (i.e., Flight Level) on the left side of the display, the altitude window. In addition the ID code is displayed in the right window, the ident window. A fault in the altitude interface or an invalid altitude input to the KT 73 will cause the display to show a series of dashes when the ALT mode is selected.

### **'SBY'**

**'SBY'** is displayed in the altitude window when SBY mode is selected by the Function Selector Knob. In addition the ID code is displayed in the right window, the ident window.

### **'GND'**

**'GND'** is only displayed on the left side (altitude window) when the aircraft is on ground. The ID code is shown on the right side, the ident window.

### **'FLT IDT'**

The **'FLT IDT'** is annunciated and the flight ID is illuminated in the display area when the FLT ID mode is selected by the Function Selector Knob.

### **'TEST OK'**

**'TEST OK'** is displayed in the Test mode if no faults are detected.

### **'SBY FXYZ'**

If one or more fault is detected in the Test mode, **'SBY'** is displayed in the altitude window and the ident window will cycle through all detected faults indicated by **'FXYZ'**. The **'XYZ'** denotes the specific fault.

## **917.1E PROGRAMMING MODE**

The programming mode is normally set at time of installation, including the unique Mode S aircraft address. The programming mode should not be used during flight. Refer to the KT 73 Installation Manual 006-10563-0004 latest revision.

## **917.1F AIR/GROUND SWITCHING**

The AUTO GND (Automatic Ground Programming) function is not available.

### **917.1G FAILURE ANNUNCIATION**

If the unit detects an internal failure, FAIL annunciation light on the left side of the displays will illuminate.

### **917.2 LIMITATIONS**

Not applicable.

### **917.3 EMERGENCY PROCEDURES**

#### **IMPORTANT CODES**

7600 Loss of communications.

7500 Hijacking.

7700 Emergency (All secondary surveillance radar sites are ready to receive this code at all times).

See the Airman's Information Manual (AIM) for a detailed explanation of identification codes.

### **917.4 NORMAL PROCEDURES**

Not applicable.

### **917.5 PERFORMANCE**

Not applicable.

**Left blank intentionally**

---

---

**SECTION 918**

**BECKER ATC 2000 TRANSPONDER**

**Table of Contents**

<i>Paragraph</i>		<i>Page</i>
<b>918.1</b>	<b>GENERAL .....</b>	<b>918-3</b>
918.1.1	Built-in Test .....	918-4
918.1.2	Squawk selection .....	918-4
918.1.3	Mode A Operation .....	918-5
918.1.4	Mode A and C Operation .....	918-5
<b>918.2</b>	<b>LIMITATIONS .....</b>	<b>918-5</b>
<b>918.3</b>	<b>EMERGENCY PROCEDURES .....</b>	<b>918-5</b>
918.3.1	Important Codes .....	918-5
<b>918.4</b>	<b>NORMAL PROCEDURES .....</b>	<b>918-6</b>
<b>918.5</b>	<b>PERFORMANCE .....</b>	<b>918-6</b>

**Left blank intentionally**

918.1 GENERAL

The Becker panel mounted ATC 2000 Transponder is a radio transmitter and receiver that fulfills the role of the airborne beacon equipment according to the requirements of the Air Traffic Radar Beacon System (ATCRBS). Its functionality includes replying to ATCRBS Mode A and Mode C interrogations.

It operates on radar frequencies, receiving ground radar interrogations at 1030 MHz and transmitting a coded response of pulses to ground-based radar on a frequency of 1090 MHz. The ATC 2000 is equipped with IDENT capability that activates the Special Position Identification (SPI) pulse.

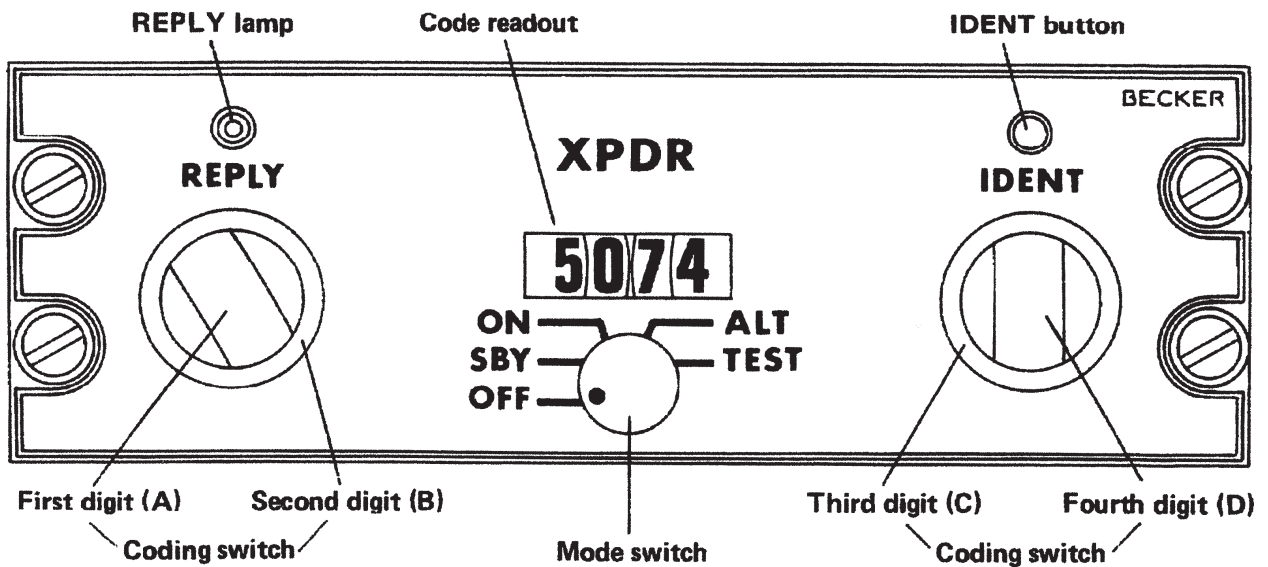

Controls	Description	Function
OFF/SBY/ON/ALT/TEST mode switch	Four-Position rotary switch and one key position	OFF Transponder is switched off (with exception of panel lighting)
		SBY Transmitter tube warm-up
		ON Transponder responds to mode A interrogation with the set code
		ALT Transponder responds to mode A and mode C interrogation
TEST Built-in test by interrogation simulation, REPLY lamp must light up		
IDENT button	Pushbutton	Pressing the IDENT button the transponder transmits an SPI pulse
REPLY lamp	Lamp, orange, with dimmer	Lights up if transponder responds; intensity set by means of a mechanical dimmer
4 coding switches	Rotary switches with eight positions	Setting the code from 0000 to 7777 permitting 4096 different digit combinations
Code readout	Digital readout, each digit from 0 to 7	Indication of coding from 0000 to 7777

**NOTE**

The ATC 2000 owner accepts all responsibility for obtaining the proper license before using the transponder.

**Caution**

Do not switch on or off the transponder until the engines have been started or stopped respectively to avoid damage to the transponder due to current surges.

**918.1.1 BUILT-IN TEST**

- 1 Position mode switch from **OFF** to **SBY**. Operate the transponder approx. 60s in the SBY position since transmitting tube must warm up and stabilize prior to operation. It is, however, possible to skip the **SBY** position without danger for the transmitter tube, since the latter is safeguarded by cavity protection circuit which also requires approx. 60s to warm up.
- 2 Turn mode switch as far as it will go to **TEST** (key position) in which the transponder simulates interrogation, prompting a reply. The reply indication is given by the reply lamp illuminating.

**918.1.2 SQUAWK SELECTION**

Squawk selection is done with the four rotating knobs to provide 4096 identification codes. Important Codes:

1200 The VFR code for any altitude in the US (Refer to ICAO standards elsewhere)

7000 The VFR code commonly used in Europe (Refer to ICAO standards)

0021 The VFR code commonly used in Germany (default is set to 0021 at time of installation)

7500 Hijack code (Aircraft is subject to unlawful interference)

7600 Loss of communications

7700 Emergency

7777 Military interceptor operations (Never squawk this code)

0000 Military use (Not enterable)

Avoid selecting code 7500 and all codes in the 7600-7777 range. These trigger special indicators in automated facilities. Only the code 7500 will be decoded as the hijack code. An aircraft's transponder code (if available) is utilized to enhance the tracking capabilities of the ATC facility, therefore care should be taken when making routine code changes.

### 918.1.3 MODE A OPERATION

- 1 Activate the transponder on ATC request only. To ensure instant readiness, position the mode switch to **SBY** (standby) during the flight.
- 2 Set the code requested by ATC using the four coding switches. Set two-digit code numbers in the first two windows of the readout.

#### **Caution**

**Only operate the coding switches in the SBY (standby) mode.**

- 3 Switch the mode switch **ON** on ATC request, the transponder then responding to mode A interrogation with dialed code, as indicated by the REPLY lamp coming on.
- 4 Only press the **IDENT** button briefly when requested by ATC, causing a special identification pulse (SPI pulse) being transmitted, permitting instant identification of the aircraft on the ATC radar system.

### 918.1.4 MODE A AND C OPERATION

- 1 Position mode switch to **ALT** on ATC request only. The transponder then responds with dialed code, causing REPLY lamp to light up and additionally transmits the height of the aircraft to ATC.
- 2 Press the **IDENT** button briefly when requested by ATC, causing a special identification pulse (SPI pulse) being transmitted, permitting instant identification of the aircraft on the ATC radar system.

### 918.2 LIMITATIONS

Not applicable.

### 918.3 EMERGENCY PROCEDURES

#### 918.3.1 IMPORTANT CODES

7600 Loss of communications.

7500 Hijacking.

7700 Emergency (All secondary surveillance radar sites are ready to receive this code at all times).

See the Airman's Information Manual (AIM) for a detailed explanation of identification codes.

**918.4 NORMAL PROCEDURES**

Not applicable

**918.5 PERFORMANCE**

Not applicable

---

---

**SECTION 919**

**BECKER ATC 4401 TRANSPONDER**

**Table of Contents**

<i>Paragraph</i>		<i>Page</i>
<b>919.1</b>	<b>GENERAL .....</b>	<b>919-3</b>
919.1.1	Controls and indicators .....	919-4
919.1.2	Switching on the unit (pre-flight check) .....	919-4
919.1.3	Squawk selection .....	919-5
919.1.4	Flight operation in Mode A (transponder reply code only) .....	919-7
919.1.5	Flight operation in Mode A+C (reply code and altitude code) .....	919-7
919.1.6	Squawk Ident .....	919-7
919.1.7	Test .....	919-7
919.1.8	Configuration Mode .....	919-8
<b>919.2</b>	<b>LIMITATIONS .....</b>	<b>919-8</b>
<b>919.3</b>	<b>EMERGENCY PROCEDURES .....</b>	<b>919-8</b>
919.3.1	Important Codes .....	919-8
<b>919.4</b>	<b>NORMAL PROCEDURES .....</b>	<b>919-8</b>
<b>919.5</b>	<b>PERFORMANCE .....</b>	<b>919-8</b>

**Left blank intentionally**

**919.1 GENERAL**

The Becker panel mounted ATC 4401 Transponder is a radio transmitter and receiver that fulfills the role of the airborne beacon equipment according to the requirements of the Air Traffic Radar Beacon System (ATCRBS). Its functionality includes replying to ATCRBS Mode A and Mode C interrogations.

It operates on radar frequencies, receiving ground radar interrogations at 1030 MHz and transmitting a coded response of pulses to ground-based radar on a frequency of 1090 MHz. The ATC 4401 is equipped with IDENT capability that activates the Special Position Identification (SPI) pulse.

**NOTE**

**The ATC 4401 owner accepts all responsibility for obtaining the proper license before using the transponder. Refer to Becker Pilot's Guide.**

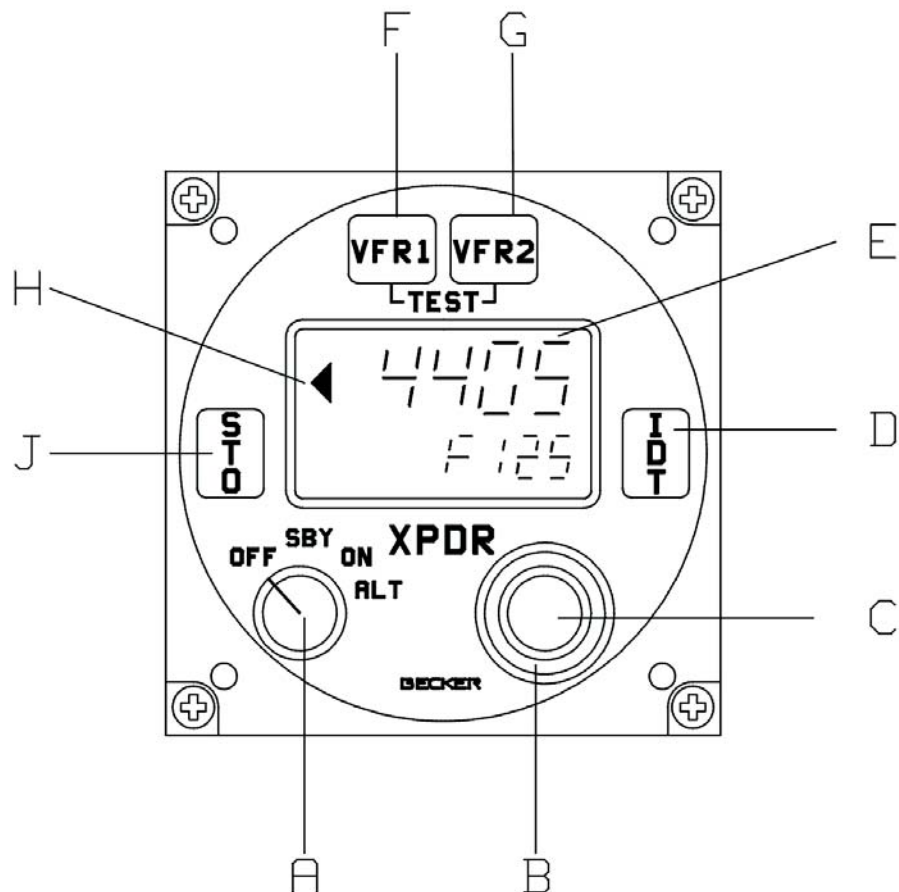

**919.1.1 CONTROLS AND INDICATORS**

A	OFF/SBY/ON/ALT rotary mode switch with 4 detent positions	OFF position : Transponder is switched off (expect panel lighting). SBY position : Standby mode is switched on. ON position : Mode A is switched on. ALT position : Mode A+C is switched on.
B	Rotary coding switch with 8 detents positions, continuously rotatable	Control of the cursor in one of the 4 code digits or from the display field
C	Rotary coding switch with 8 detents positions continuously rotatable	Setting the code digits from 0 to 7.
D	Ident push-button IDT	In Mode A and Mode A+C this triggers the transmission of an identification impulse additional to the Mode A reply code for approx. 18 seconds. During this time "ldt" appears in the bottom line of the LC display.
E	2-line LC display	Code indication (top line): Codes from 0000 to 7777 are possible.
		"Mode indication (bottom line) : SBY mode: ""SbY"" is displayed."
		"Mode A (ON): ""On"" appears in the display ""IDT"" is displayed the duration of the identification function."
		"Mode A+C (ALT):If a valid altitude is present, the flight level (height in steps of 100 ft) preceded by F (e.g. ""F241""= 24100 ft) appears. If no valid altitude code is present, ""FN-"" is displayed. The flight level display can be switched off in the configuration mode. ""ldt"" is displayed for the duration of the identification function."
F	Code push-button VFR1	Activates a first user-specific VFR code
G	Code push-button VFR2	Activates a second user-specific VFR code.
H	Reply indication REPLY	The triangle signals a Transponder reply.
J	Store push-button STO	Stores user-specific VFR codes or changes in the configuration mode

**919.1.2 SWITCHING ON THE UNIT (PRE-FLIGHT CHECK)**

- 1 Check that the circuit breaker is set and switch on the aircraft power supply .

**CAUTION**

**Do not switch on the transponder if the motors or engines are being started or shut down.**

- 2 Using mode switch (A), switch the transponder from **OFF** to **SBY**. A test then follows automatically for 3 seconds. The display is flashing with all digits and the unit is subject to a self-test simultaneously.

- 3 After the switch-on test has elapsed and no error-message is written in the display, the transponder switches to the mode set on the mode switch (A).

**Note**

**The blind encoder is only powered if the transponder is not switched OFF (at least SBY). A blind encoder needs a warm-up time (sometimes a several minutes). Therefore although the solid state transponder needs no warm-up time, turn the transponder to SBY immediately after starting the engine.**

### 919.1.3 SQUAWK SELECTION

- 1 The transponder remains switched in the standby mode until requested by the ground station (ATC) to transmit a code, e.g. „squawk alpha 6426“.
- 2 Using the double rotary switch (B,C) set the 4-digit code requested by ATC as follows :
  - a Using switch (B) move the cursor to the particular digit. Digits 0 to 7 can then be set using switch (C).

**NOTES**

**If switch (B) is turned clockwise or counter-clockwise, the cursor is moved one position to the right or the left. The cursor appears only in the code display and is indicated by the flashing digit. If no cursor is visible, the first digit flashes after a clockwise rotation and the last digit after a counter-clockwise rotation. When the code is being changed in the ON or ALT position, the transponder temporarily switches to the standby mode.**

**The active time of the cursor and the rate of flashing can be changed in the configuration mode.**

- b If the cursor is not moved again within of 3 seconds (can be changed in configuration mode) or if the cursor is moved so far that it can no longer be seen in the display field or the identification switch is pressed (in the ON or ALT mode), the code currently set is switched active.

**NOTES**

**Whilst settings are taking place, the transmission branch of the transponder is inhibited to prevent unintentional transmission.**

**If only two digits were named by ATC, e.g. „Squawk alpha 64“, then a zero is to be used for positions three and four, i.e. „6400“.**

- c The last used code is stored in each case and is also activated when the transponder is switched on.

### SPECIAL VFR CODINGS

Two user-specific VFR codes can be stored and activated on the transponder.

- 1 Storing a new VFR code:
  - a Set the code to be stored in accordance with section B.

- b Press store push-button **STO** (J), the set code then flashes.
- c Press the **VFR1** push-button (F) or the **VFR2** push-button (G) within 3 seconds to store the code under the corresponding button.
- d If neither button (F) or (G) is pressed within 3 seconds, the flashing stops and the storage operation is aborted.

**NOTE**

**If one of the two buttons (F) or (G) is pressed without the STO button having been pressed beforehand, then the stored code allocated this button appears in the code display and is switched to active after 3 seconds (can be changed in the configuration mode). If the same button is again pressed within 3 seconds, the previous code appears.**

2 Activation of the VFR codes:

- a Press the **VFR** push-button **1** or **2** (F, G). The selected code is then displayed. After 3 seconds, the displayed code becomes active and overwrites the previously-set reply code.
- b Pressing button (F) or (G) again within 3 seconds reactivates the previously-set reply code.

**NOTE**

**When the unit is delivered, the store buttons are not assigned a code. This means that if these buttons are pressed for 0.5 seconds, „—“ is shown in the code display and the transponder then switches back to the previously-active code.**

**IMPORTANT CODES:**

- 1200 The VFR code for any altitude in the US (Refer to ICAO standards elsewhere)
- 7000 The VFR code commonly used in Europe (Refer to ICAO standards)
- 0021 The VFR code commonly used in Germany (default is set to 0021 at time of installation)
- 7500 Hijack code (Aircraft is subject to unlawful interference)
- 7600 Loss of communications
- 7700 Emergency
- 7777 Military interceptor operations (Never squawk this code)
- 0000 Military use (Not enterable)

Avoid selecting code 7500 and all codes in the 7600-7777 range. These trigger special indicators in automated facilities. Only the code 7500 will be decoded as the hijack code. An aircraft's transponder code (if available) is utilized to enhance the tracking capabilities of the ATC facility, therefore care should be taken when making routine code changes.

---

---

**Note**

**Unintentional transmission of an emergency code is prevented in that the transponder replies are inhibited whilst the code is being set. This applies particularly where the new code is being set in the ON or ALT modes. Also if a special code is called up, no transponder reply takes place during the period in which the previous code can be reactivated (approximately 3 seconds).**

**919.1.4 FLIGHT OPERATION IN MODE A (TRANSPONDER REPLY CODE ONLY)**

- 1 Select squawk as described above.
- 2 Set mode switch (A) from **SBY** to **ON**. The transponder immediately replies with the set code. A triangle on the left next to the code signals the transponder replies.

**919.1.5 FLIGHT OPERATION IN MODE A+C (REPLY CODE AND ALTITUDE CODE)**

- 1 Select squawk as described above.
- 2 ATC requests the transmission „alpha/charlie“ or „charlie“, switch the transponder to **ALT** using mode switch (A).
- 3 The transponder replies using the code set and in response to mode C requests it transmits the flight level of the aircraft to ATC. A triangle on the left next to the code signals the transponder replies.

**919.1.6 SQUAWK IDENT**

After a „squawk ident“ request from ATC, press Ident button **IDT** (D) briefly. This transmits an additional special pulse (SPI) for approx. 18 seconds, which enables the aircraft to be clearly identified on the radar screen of the controller. **'Idt'** appears in the bottom line of the LC display during this time.

**919.1.7 TEST**

The following different tests are integrated in the transponder or can be triggered at the transponder :

- 1 Automatic switching-on test, in which the display (E) is flashing with all digits for 3 seconds. The unit is subject to a self-test in this time.
- 2 A permanent test runs in the background of the transponder operation. The built-in FPGA organizes the required resources for this. The transmitter recognizes a mismatching or own abnormal behavior and delivers an alarm signal to the FPGA.

- 3 A further test of the unit is triggered, if the **VFR1** button (F) and **VFR2** button (G) are pressed simultaneously. At this test all segments must flash into display (E) as long as the buttons are pushed. Additionally the transmitter and evaluation are tested on correct function in the SBY, ON and ALT modes.
- 4 In case of a failure appears the report e.g. '**E10**' in the top line of the display. Switch OFF the transponder at such '**E**' fault indications.

### **919.1.8 CONFIGURATION MODE**

The configuration Mode is used to set the unit on the ground and must not be called up in flight. Refer to BECKER's Pilot's Guide for further information.

### **919.2 LIMITATIONS**

Not applicable.

### **919.3 EMERGENCY PROCEDURES**

#### **919.3.1 IMPORTANT CODES**

7600 Loss of communications.

7500 Hijacking.

7700 Emergency (All secondary surveillance radar sites are ready to receive this code at all times).

See the Airman's Information Manual (AIM) for a detailed explanation of identification codes.

### **919.4 NORMAL PROCEDURES**

Not applicable

### **919.5 PERFORMANCE**

Not applicable

---

---

**SECTION 920**

**BECKER ATC 6401 TRANSPONDER**

**Table of Contents**

<i>Paragraph</i>		<i>Page</i>
<b>920.1</b>	<b>GENERAL .....</b>	<b>920-3</b>
920.1.1	Controls and Indicators .....	920-4
920.1.2	Switching on the Unit (pre-flight check) .....	920-4
920.1.3	Display .....	920-5
920.1.4	Squawk Selection .....	920-5
920.1.5	Squawk Ident .....	920-6
920.1.6	Selftests of the Unit (BITs) .....	920-6
920.1.7	Selection Mode .....	920-7
920.1.8	Flight Operation in Mode A/C/S (reply code and altitude code) .....	920-9
920.1.9	VFR Code Activation .....	920-10
920.1.10	Configuration Mode .....	920-10
<b>920.2</b>	<b>LIMITATIONS .....</b>	<b>920-10</b>
<b>920.3</b>	<b>EMERGENCY PROCEDURES .....</b>	<b>920-10</b>
920.3.1	Important Codes .....	920-10
<b>920.4</b>	<b>NORMAL PROCEDURES .....</b>	<b>920-10</b>
<b>920.5</b>	<b>PERFORMANCE .....</b>	<b>920-10</b>

**Left blank intentionally**

**920.1 GENERAL**

The Becker panel mounted ATC 6401 Transponder is a radio transmitter and receiver that fulfills the role of the airborne beacon equipment according to the requirements of the Air Traffic Radar Beacon System (ATCRBS). Its functionality includes replying to ATCRBS Mode A, C and Mode S interrogations.

It operates on radar frequencies, receiving ground radar interrogations at 1030 MHz and transmitting a coded response of pulses to ground-based radar on a frequency of 1090 MHz. The ATC 6401 is equipped with IDENT capability that activates the Special Position Identification (SPI) pulse.

**NOTE**

**The ATC 6401 owner accepts all responsibility for obtaining the proper license before using the transponder. Refer to Becker Pilot's Guide.**

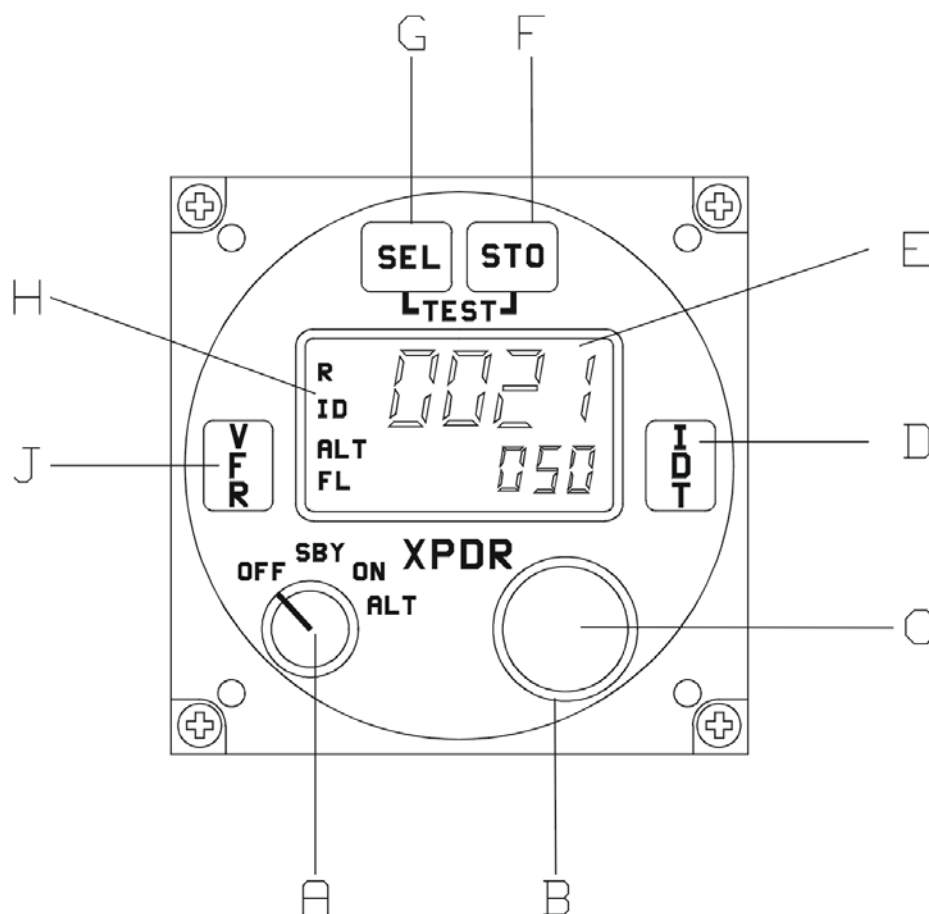

### 920.1.1 CONTROLS AND INDICATORS

A	Mode Selector	Rotary switch with 4 positions	OFF position : Transponder is switched off SBY position : Standby mode is switched on ON position: Mode A/S is switched on. Transmission of altitude information is suppressed ALT position: Mode A/C/S is switched on and the altitude information is transmitted.
B	Rotary switch	Rotary optical encoder (rotary mode of C)	Rotary switch to change settings (16 steps per turn)
C	Button	Push-button (mode of B)	Push to jump from digit to digit for settings or from one menu to the next; generally used as an enter key
D	IDT	Push-button	Activates the Special Identifier (SPI) in addition to the reply code for approx. 18 seconds; during this time "ID" appears in the LC display
E	Display, part 1	2-line LCD display	Displays the following informations: - code indication in the top row - flight level in the bottom row - various informations in the bottom row - additional indicators on the left side (see Ref. H)
F	STO	Push-button	Stores the selected values to the settings
G	SEL	Push-button	Opens and selects the menu
H	Display, part 2	LCD indicators	Displays additional indicators, (R for reply, ID for Ident, ALT for XPDR ALT mode or ON for XPDR ON mode, FL for flight level)
J	VFR	Push-button	Activates VFR code in the upper row of the display

### 920.1.2 SWITCHING ON THE UNIT (PRE-FLIGHT CHECK)

- 1 Check that the circuit breaker is set and switch on the aircraft power supply .

**CAUTION**

**Do not switch on the transponder if the motors or engines are being started or shut down.**

- 2 Using mode selector (A), switch the transponder from **OFF** to **SBY**. A test then follows automatically for 1 seconds. The display shows '**WAIT**' and the unit is subject to a self-test simultaneously.
- 3 After the switch-on test has elapsed and no error-message is written in the display, the transponder switches to the mode set on the mode selector (A).

**Note**

**The blind encoder is only powered if the transponder is not switched OFF (at least SBY). A blind encoder needs a warm-up time (sometimes a several minutes). Therefore although the solid state transponder needs no warm-up time, turn the transponder to SBY immediately after starting the engine.**

**920.1.3 DISPLAY**

Transponder's code is displayed in the top line using high readability font, at all times in modes SBY, ON, ALT. Depending on the configuration settings, the Aircraft Identification (AI) or Flight Number (FN) is displayed in the bottom line. Flight level is displayed in ALT mode in the bottom line of the display (altitude= FL x 100 in ft).

**920.1.4 SQUAWK SELECTION**

- 1 The transponder remains switched in the standby mode until requested by the ground station (ATC) to transmit a code, e.g. „squawk alpha 6426“.
- 2 Using the rotary switch (B) and the button (C) set the 4-digit code requested by ATC as follows:
  - a Using switch (C) move the cursor to the particular digit. Digits 0 to 7 can then be set using the rotary switch (B).

**NOTES**

**Whilst settings are taking place, the transmission branch of the transponder is inhibited to prevent unintentional transmission.**

**If only two digits were named by ATC, e.g. „Squawk alpha 64“, then a zero is to be used for positions three and four, i.e. „6400“.**

- b The last used code is stored in each case and is also activated when the transponder is switched on.

**IMPORTANT CODES:**

- 1200 The VFR code for any altitude in the US (Refer to ICAO standards elsewhere)
- 7000 The VFR code commonly used in Europe (Refer to ICAO standards)
- 0021 The VFR code commonly used in Germany (default is set to 0021 at time of installation)
- 7500 Hijack code (Aircraft is subject to unlawful interference)
- 7600 Loss of communications
- 7700 Emergency

7777 Military interceptor operations (Never squawk this code)

0000 Military use (Not enterable)

Avoid selecting code 7500 and all codes in the 7600-7777 range. These trigger special indicators in automated facilities. Only the code 7500 will be decoded as the hijack code. An aircraft's transponder code (if available) is utilized to enhance the tracking capabilities of the ATC facility, therefore care should be taken when making routine code changes.

**Note**

**Unintentional transmission of an emergency code is prevented in that the transponder replies are inhibited whilst the code is being set. This applies particularly where the new code is being set in the ON or ALT modes. Also if a special code is called up, no transponder reply takes place during the period in which the previous code can be reactivated (approximately 3 seconds).**

**920.1.5 SQUAWK IDENT**

After a „squawk ident“ request from ATC, press Ident button **IDT** (D) briefly. This transmits an additional special pulse (SPI) for approx. 18 seconds, which enables the aircraft to be clearly identified on the radar screen of the controller. '**Idt**' appears in the bottom line of the LC display during this time.

**920.1.6 SELFTESTS OF THE UNIT (BITS)**

The following different tests are integrated in the transponder or can be triggered at the transponder:

- 1 The IBIT (Initiated Built-in Test) can be activated in any mode (excluding the configuration mode) with the push of (F) and (G) at the same time. The action starts with the leading edge of the second pushed button. The IBIT works as follows in all modes:

The test starts with all available test routines including the transmitter test routine. During the test, '**IBIT**' is indicated on the display. The test takes not longer than 1 second. If the IBIT was successful, the XPDR switches immediately into the normal operating mode. During the IBIT any action from other switches is not recognized.

Negative results of the IBIT are indicated on the display with '**FAILURE**'. The transponder may be not switched into ON or ALT mode if any failure was found.

- 2 The CBIT (Continuous Built-in Test) works as follows:

The continuous BIT acts as a kind of watchdog during operation. Negative results of the CBIT are indicated on the display with '**FAILURE**'. In this case the transponder may be not switched into ON or ALT mode (display indication of operating mode set to '**SBY**') if any failure was found.

- 3 The PBIT (Power-on Built-in Test) works as follows:

The XPDR has a power-on BIT after switching on. During the PBIT any action from other switches are not accepted.

During the PBIT the XPDR is in the SBY mode but this is not indicated on the display. The operating mode indication on the display starts immediately after finalisation of the PBIT.

Negative results are indicated on the display with '**FAILURE**'. The transponder may be not switched into ON or ALT mode if any failure was found.

The PBIT takes not longer than 1 second. If the test was successful, the XPDR switches immediately into the normal operating mode.

### 920.1.7 SELECTION MODE

Press **SEL** button (G) and rotate encoder (B) for selection. In selection mode additional information is displayed in the bottom line of the display. Some of the data are editable, some are read only:

VFR	4096 code presetting	editable
AI	Aircraft Identifier (Tail Number)	fixed; read only from address module (an be replaced by FN). If no valid AI is stored, "-----" is displayed.
FN	Flight Number or Company Call Sign	editable; can be replaced by AI (fixed) by selecting "AI DEF"
AA	Aircraft Address (24-bit ICAO)	fixed; read only from address module (unique number for each aircraft)
MA	Maximum Airspeed	fixed; read only from address module
AT	Aircraft Type	fixed; read only from address module
CFG	Configuration	available in SBY mode only
INS	Installation setup	available in SBY mode only; protected by password

### AIRCRAFT IDENTIFICATION (AI OR FN)

**With flight plan:**

The definition out of the flight plan: e.g. Flight Number or Company Call Sign

**Without flight plan (VFR):**

Tail Number (Call Sign)

The indication of '**AI**' in the bottom line of the display is in mode SBY and ON only if selected in configuration menu. The Aircraft Identifier (fixed) is available in any mode after pressing **SEL** button (G) and turning the rotary encoder (B). The default value for AI is the Tail Number of the aircraft and is stored in the Address Module.

If a flight plan exists, it has to be checked, which AI has to be used. If a Flight Number is assigned it has to be entered. If a Company Call Sign is mentioned, this has to be entered. To enter it see below. It will be stored in the EEPROM of the control head. In this case the indication on the display changes to '**FN**' (Flight Number). If the Call Sign (Tail Number) is mentioned, no change, as it is the default setting from the Address Module.

**SETTING THE FLIGHT NUMBER:**

- 1 Press **SEL** button (G) to enter the select mode.
- 2 Rotate (B) until '**AI**' is displayed.
- 3 Push (C) to switch to '**FN**'. The cursor is set on the first character.
- 4 Rotate (B) to change this character.
- 5 Push (C) to set the cursor to the next character.
- 6 Repeat steps 4 and 5 until the flight number is entered.
- 7 If the flight number consists of less than 7 characters, put a space at the end to fill the remaining characters with spaces.
- 8 Store the changes with **STO** button (F). For leaving the setting procedure without storing, push the **SEL** button (G).

**NOTE**

**Aircraft Identifier / Flight Number consists of max. 7 characters (on the left- hand side oriented). No dashes or spaces shall be included. If the FN consists of less than 7 characters, the remaining characters on the right side shall be filled with spaces.**

**SWITCHING BACK TO DEFAULT AI:**

- 1 Press **SEL** button (G) to enter the select mode.
- 2 Rotate (B) to the indication '**FN=XXXXXXXX**'.
- 3 First push on (C) indicates '**FN=AI DEF**' (inverted).
- 4 Can be set to '**AI=DEF**' with **STO** button (F).

**CHANGING THE FLIGHT NUMBER:**

- 1 Press **SEL** button (G).
- 2 Rotate (B) until '**FN**' is displayed.
- 3 Push (C) twice to enter the FN editing mode.
- 4 Change the FN as described above.

## VFR CODE PRESETTING

Press the **SEL** button (G) to get into configuration mode (selection is indicated in the left bottom corner of the display under the operating mode indication).

- 1 Rotate (B) to the indication '**VFR=XXXX**'.
- 2 First push to button (C) now left digit of the code is inverted.
- 3 Now the digit can be changed with (B).
- 4 Second push to button (C) now next left digit of the code is inverted.
- 5 The next digit can be changed with (B)
- 6 and the same for next digits.
- 7 Fifth push to button (C) now again first digit is inverted.
- 8 Changes can be stored with **STO** button (F) at any time, inversion stops in this case.
- 9 A VFR code that was preset in this way can be activated as described in chapter *VFR Code Activation*.
- 10 A timeout for inversion (10 sec) is introduced if no action happens. Nothing stored, as long as (F) is not pressed.

### NOTE

**It is possible to leave the setting procedure with SEL button (G) at any time and normal mode is available then. Indication SEL on the display changes back to mode indication. If STO button (F) was not used, no change has been stored.**

## 920.1.8 FLIGHT OPERATION IN MODE A/C/S (REPLY CODE AND ALTITUDE CODE)

- 1 When ATC requests the transmission „squawk“, switch the transponder to **ALT** using mode switch (A).

### NOTE

**In exceptions the altitude has to be turned off, i.e. switch the transponder to ON using mode switch (A).**

- 2 The transponder replies using the selected Code and in response to mode C interrogation it transmits the altitude of the aircraft to ATC. A 'R' on the left next to the Code on the display signals the transponder replies.

### NOTE

**Switch the transponder to Stand-by (SBY), if the Code has to be changed. Otherwise it could happen that a Code with a special meaning (see chapter K, e.g. hijack) will be transmitted and unwanted actions could take place.**

### 920.1.9 VFR CODE ACTIVATION

- 1 Press the **VFR** push-button (J). The preselected code is then displayed. After 3 seconds, the displayed code gets active and overwrites the previously-set reply code.
- 2 Pressing push-button (J) again within 3 seconds reactivates the previously-set reply code.

#### **NOTE**

**When the unit is delivered, the VFR button is not assigned a code. This means that if this button is pressed for 0.5 seconds, „—“ is shown in the code display and the transponder then switches back to the previously-active code.**

### 920.1.10 CONFIGURATION MODE

The configuration mode is available from SBY mode only. To get into configuration mode press button **SEL** (G), turn rotary encoder (B) until '**CFG**' appears in the bottom row of the display. Refer to BECKER's Pilot's Guide for available options.

### 920.2 LIMITATIONS

Not applicable.

### 920.3 EMERGENCY PROCEDURES

#### 920.3.1 IMPORTANT CODES

7600 Loss of communications.

7500 Hijacking.

7700 Emergency (All secondary surveillance radar sites are ready to receive this code at all times).

See the Airman's Information Manual (AIM) for a detailed explanation of identification codes.

### 920.4 NORMAL PROCEDURES

Not applicable

### 920.5 PERFORMANCE

Not applicable

---